

Board 1 SKYPER 32 R

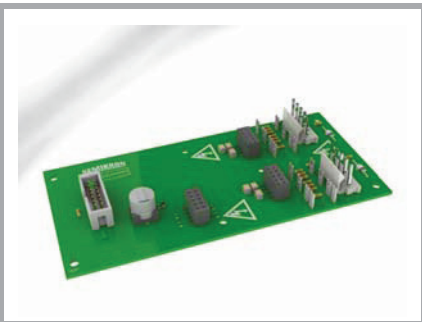

SKYPER®

Adaptor board

Board 1 SKYPER 32 R

Preliminary Data

Features

- Two output channels
- Failure management

Typical Applications*

- Adaptor board for SKYPER 32 IGBT drivers in bridge circuits for industrial applications
- DC bus up to 1200V

Footnotes

All characteristics listed in the data sheet are guilty for the use with SKYPER 32. Please consider the derating of the ambient temperature. Please refer to the datasheet of SKYPER 32 for further information.

Absolute Maximum Ratings			
Symbol	Conditions	Values	Unit
V _s	Supply voltage primary	16	V
I _{outPEAK}	Output peak current	15	A
I _{outAVmax}	Output average current	50	mA
f _{max}	max. switching frequency	50	kHz
V _{CE}	Collector emitter voltage sense across the IGBT	1700	V
V _{isol IO}	Isolation test voltage input - output (AC, rms, 2s)	4000	V
V _{isolPD}	Partial discharge extinction voltage, rms, Q _{PD} ≤ 10pC	1500	V
V _{isol12}	Isolation test voltage output 1 - output 2 (AC, rms, 2s)	1500	V
R _{Gon min}		1.5	Ω
R _{Goff min}	Minimum rating for external R _{Goff}	1.5	Ω
T _{op}	Operating temperature	-25 ... 85	°C
T _{stg}	Storage temperature	-25 ... 85	°C

Characteristics					
Symbol	Conditions	min.	typ.	max.	Unit
V _s	Supply voltage primary side	14.4	15	15.6	V
V _j	input signal voltage on / off		15 / 0		V
V _{IT+}	Input threshold voltage HIGH			12.3	V
V _{IT-}	Input threshold voltage (LOW)	4.6			V
V _{G(on)}	Turn on gate voltage output		15		V
V _{G(off)}	Turn off gate voltage output		-7		V
t _{d(on)IO}	Input-output turn-on propagation time		1.1		μs
t _{d(off)IO}	Input-output turn-off propagation time		1.1		μs

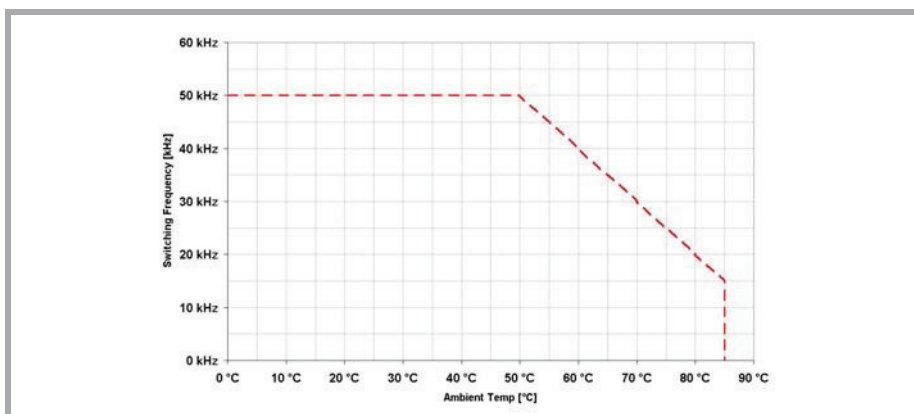

Derating

This is an electrostatic discharge sensitive device (ESDS), international standard IEC 60747-1, Chapter IX

* The specifications of our components may not be considered as an assurance of component characteristics. Components have to be tested for the respective application. Adjustments may be necessary. The use of SEMIKRON products in life support appliances and systems is subject to prior specification and written approval by SEMIKRON. We therefore strongly recommend prior consultation of our personal.

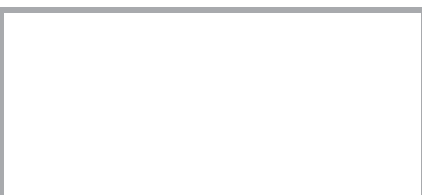

Adaptor board

Adaptor Board 1 SKYPER[®] 32 R

Technical Explanations

Revision 01

This Technical Explanation is valid for the following parts:

part number	type	date code (YYWW)
L6100131	Board 1 SKYPER [®] 32 R	≥ 1004

Related documents:

title
Technical Explanations SKYPER [®] 32 R

Prepared by: Johannes Krapp

Content

Application and Handling Instructions	2
Further application support	3
General Description	3
Component Placement Layout	4
PIN Array (not SKiiP [®] compatible)	4
PIN Array – Secondary Side	5
Setting Dynamic Short Circuit Protection	5
Collector Series Resistance	6
Adaptation Gate Resistors	6
Boost Capacitors	6
Mounting Notes	7

Please note:

All values in this technical explanation are typical values. Typical values are the average values expected in large quantities and are provided for information purposes only. These values can and do vary in different applications. All operating parameters should be validated by user's technical experts for each application.

Board 1 SKYPER® 32 R - Technical Explanations

- Please provide for static discharge protection during handling. As long as the hybrid driver is not completely assembled, the input terminals have to be short-circuited. Persons working with devices have to wear a grounded bracelet. Any synthetic floor coverings must not be statically chargeable. Even during transportation the input terminals have to be short-circuited using, for example, conductive rubber. Worktables have to be grounded. The same safety requirements apply to MOSFET- and IGBT-modules.
- Any parasitic inductances within the DC-link have to be minimised. Over-voltages may be absorbed by C- or RCD-snubber networks between main terminals for PLUS and MINUS of the power module.
- When first operating a newly developed circuit, SEMIKRON recommends to apply low collector voltage and load current in the beginning and to increase these values gradually, observing the turn-off behaviour of the free-wheeling diode and the turn-off voltage spikes generated across the IGBT. An oscillographic control will be necessary. Additionally, the case temperature of the module has to be monitored. When the circuit works correctly under rated operation conditions, short-circuit testing may be done, starting again with low collector voltage.
- It is important to feed any errors back to the control circuit and to switch off the device immediately in failure events. Repeated turn-on of the IGBT into a short circuit with a high frequency may destroy the device.
- The inputs of the hybrid driver are sensitive to over-voltage. Voltages higher than $V_S + 0,3V$ or below $-0,3V$ may destroy these inputs. Therefore, control signal over-voltages exceeding the above values have to be avoided.
- The connecting leads between hybrid driver and the power module should be as short as possible (max. 20cm), the driver leads should be twisted.

Further application support

Latest information is available at <http://www.semikron.com>. For design support please read the SEMIKRON Application Manual Power Modules available at <http://www.semikron.com>.

General Description

The Board 1 SKYPER® 32 is an adaptor board for the IGBT module e.g. SEMITRANS™, SEMiX® (solder pin version). The board can be customized allowing adaptation and optimization to the used IGBT module.

The switching characteristic of the IGBT can be influenced through user settings, e.g. changing turn-on and turn-off speed by variation of R_{Gon} and R_{Goff} . Furthermore, it is possible to adjust the monitoring level and blanking time for the DSCP (see Technical Explanations SKYPER® 32).

Please note:

This technical explanation is based on the Technical Explanations for SKYPER® 32PRO. Please read the Technical Explanations SKYPER® 32PRO before using the Adaptor Board.

Board 1 SKYPER® 32 R

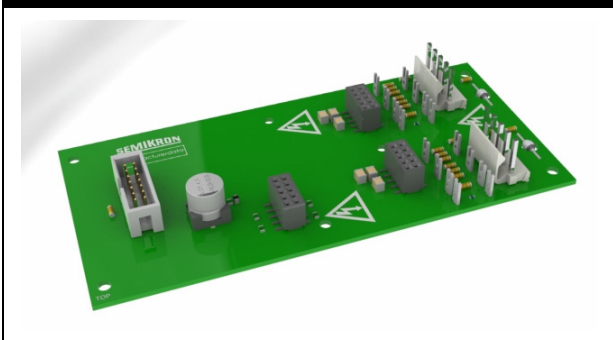

Board 1 SKYPER[®] 32 R - Technical Explanations

Component Placement Layout

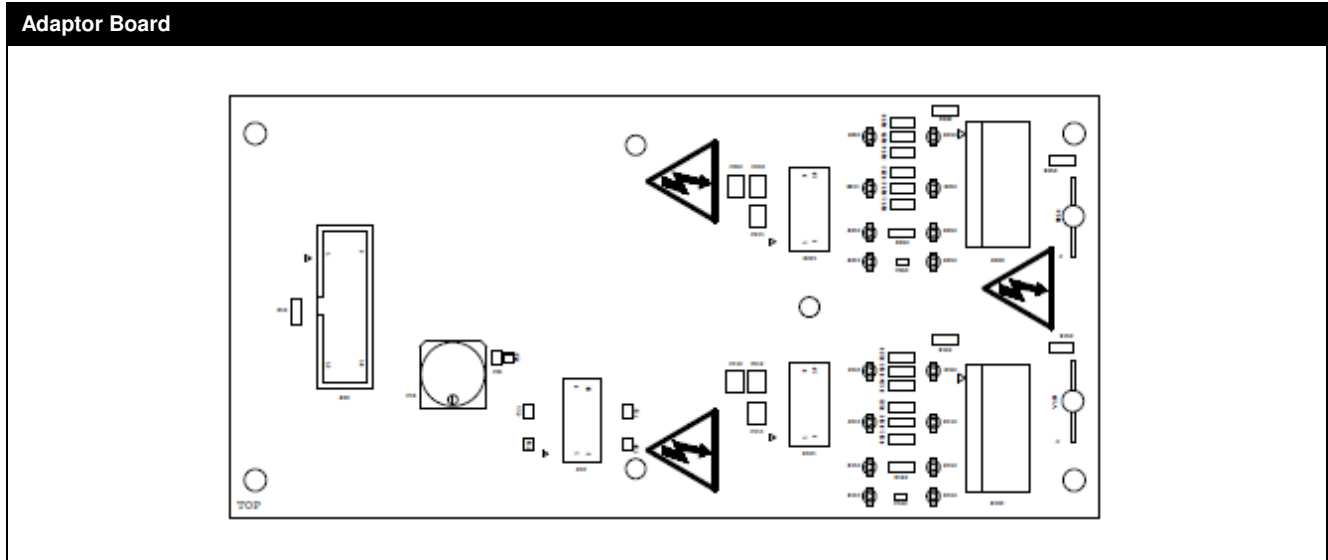

PIN Array (not SKiiP[®] compatible)

Connector X20 (ODU FLAKAFIX 511.068.803.020)

Product information of suitable female connectors and distributor contact information is available at e.g. <http://www.harting.com> (part number 09 18 520 6 813).

PIN	Signal	Function	Specification
X20:01	reserved		
X20:02	IF_HB_BOT	Switching signal input (BOTTOM switch)	Digital 15 V; 10 kOhm impedance; LOW = BOT switch off; HIGH = BOT switch on
X20:03	IF_nERROR_OUT	ERROR output	LOW = NO ERROR; open collector output; max. 30V / 15mA (external pull up resistor necessary)
X20:04	IF_HB_TOP	Switching signal input (TOP switch)	Digital 15 V; 10 kOhm impedance; LOW = TOP switch off; HIGH = TOP switch on
X20:05	IF_nERROR_IN	ERROR input	5V logic; LOW active
X20:06	reserved		
X20:07	reserved		
X20:08	IF_PWR_15P	Drive power supply	Stabilised +15V ±4%
X20:09	IF_PWR_15P	Drive power supply	Stabilised +15V ±4%
X20:10	IF_PWR_GND	GND for power supply and GND for digital signals	
X20:11	IF_PWR_GND	GND for power supply and GND for digital signals	
X20:12-14	reserved		

Board 1 SKYPER® 32 R - Technical Explanations

PIN Array – Secondary Side

Connector X100, X200 (MOLEX Series 41791, Part Number 26-60-4050)

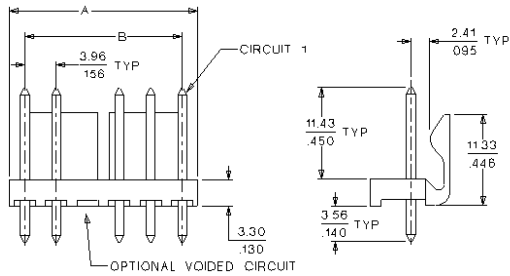

Product information of suitable female connectors and distributor contact information is available at e.g. <http://www.molex.com> (e.g. series 41695).

PIN	Signal	Function	Specification
X100:01	EMITTER_TOP	Emitter output TOP IGBT	
X100:02	reserved		
X100:03	GATE_TOP	Gate output TOP IGBT	
X100:05	VCE_TOP	Collector output TOP IGBT	
X200:01	EMITTER_BOT	Emitter output BOT IGBT	
X200:02	reserved		
X200:03	GATE_BOT	Gate output BOT IGBT	
X200:05	VCE_BOT	Collector output BOT IGBT	

Setting Dynamic Short Circuit Protection

R_{CE} & C_{CE}

Designation	Shape	Setting
R162	MiniMELF	R _{CE} Factory setting: not equipped TOP
C160	0603	C _{CE} Factory setting: not equipped TOP
R262	MiniMELF	R _{CE} Factory setting: not equipped BOT
C260	0603	C _{CE} Factory setting: not equipped BOT

Board 1 SKYPER[®] 32 R - Technical Explanations

Collector Series Resistance

R_{VCE}			
Designation	Shape	Setting	
R150	MiniMELF	R_{VCE}^* Factory setting: not equipped	TOP
R250	MiniMELF	R_{VCE}^* Factory setting: not equipped	BOT

* 1200V IGBT operation: 0Ω
1700V IGBT operation: 1kΩ / 0,4W

Adaptation Gate Resistors

R_{Gon} & R_{Goff}			
Designation	Shape	Setting	
R151, R152, R153 (parallel connected)	MiniMELF	R_{Gon} Factory setting: not equipped	TOP
R154, R155, R156 (parallel connected)	MiniMELF	R_{Goff} Factory setting: not equipped	TOP
R251, R252, R253 (parallel connected)	MiniMELF	R_{Gon} Factory setting: not equipped	BOT
R254, R255, R256 (parallel connected)	MiniMELF	R_{Goff} Factory setting: not equipped	BOT

Boost Capacitors

$C_{boost15P}$ & $C_{boost8N}$			
Designation	Shape	Setting	
C112	1210	$C_{boost8N}$ Factory setting: 4,7μF/25V *	TOP
C110	1210	$C_{boost8N}$ Factory setting: 4,7μF/25V *	TOP
C111	1210	$C_{boost15P}$ Factory setting: 2,2μF/25V *	TOP
C212	1210	$C_{boost8N}$ Factory setting: 4,7μF/25V *	BOT
C210	1210	$C_{boost8N}$ Factory setting: 4,7μF/25V *	BOT
C211	1210	$C_{boost15P}$ Factory setting: 2,2μF/25V *	BOT

* output charge pulse: 5μC

Mounting Notes

Driver Core Mounting

1. Soldering of components (e.g. R_{Gon} , R_{Goff} , etc.) on adaptor board.
2. Insert driver core into the box connector on adaptor board.
3. The connecting leads between board and power module should be as short as possible (max. 20cm), the leads should be twisted.

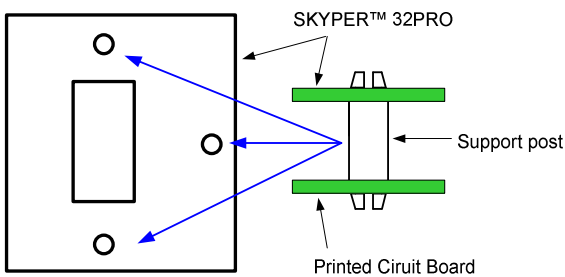

The connection between driver core and adaptor board should be mechanical reinforced by using support posts. The posts have to be spaced between driver core and adaptor board.

Product information of suitable support posts and distributor contact information is available at e.g. <http://www.richco-inc.com> (e.g. part number DLMSPM-8-01, LCBST-8-01).

DISCLAIMER

SEMIKRON reserves the right to make changes without further notice herein to improve reliability, function or design. Information furnished in this document is believed to be accurate and reliable. However, no representation or warranty is given and no liability is assumed with respect to the accuracy or use of such information. SEMIKRON does not assume any liability arising out of the application or use of any product or circuit described herein. Furthermore, this technical information may not be considered as an assurance of component characteristics. No warranty or guarantee expressed or implied is made regarding delivery, performance or suitability. This document supersedes and replaces all information previously supplied and may be superseded by updates without further notice.

SEMIKRON products are not authorized for use in life support appliances and systems without the express written approval by SEMIKRON.