

P 1000 A....P 1000 S

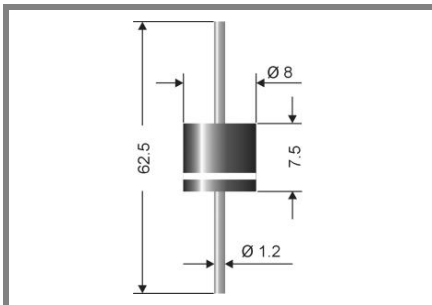

Axial lead diode

Standard silicon rectifier diodes

P 1000 A....P 1000 S

Forward Current: 10 A

Reverse Voltage: 50 to 1200 V

Features

- Max. solder temperature: 260°C
- Plastic material has UL classification 94V-0
- Max. junction temperature $T_j \leq 200^\circ\text{C}$ in bypass mode

Mechanical Data

- Plastic case 8 x 7.5 [mm]
- Weight approx.: 1.5 g
- Terminals: plated terminals solderable per MIL-STD-750
- Mounting position: any
- Standard packaging: 500 pieces per ammo or 1000 pieces per reel

- 1) Valid, if leads are kept at T_A at a distance 10 mm from case
- 2) $I_F = 5\text{A}$, $T_j = 25^\circ\text{C}$
- 3) $T_A = 25^\circ\text{C}$
- 4) $R_{thT} \leq 3\text{ K/W}$ if leads are kept at ambient temperature at a distance 0 mm from case
- 5) Max. junction temperature $T_j \leq 185^\circ\text{C}$ in reverse mode $V_R = 50\%V_{RRM}$, $T_j \leq 200^\circ\text{C}$ in bypass mode

Type	Repetitive peak reverse voltage V_{RRM} V	Surge peak reverse voltage V_{RSM} V	Max. reverse recovery time $I_F = -A$ $I_R = -A$ $I_{RR} = -A$ t_{rr} ns	Max. forward voltage $V_F^{(2)}$
P 1000 A	50	50	-	0,9
P 1000 B	100	100	-	0,9
P 1000 D	200	200	-	0,9
P 1000 G	400	400	-	0,9
P 1000 J	600	600	-	0,9
P 1000 K	800	800	-	0,9
P 1000 M	1000	1000	-	0,9
P 1000 S	1200	1200	-	0,9

Absolute Maximum Ratings		$T_A = 25^\circ\text{C}$, unless otherwise specified	
Symbol	Conditions	Values	Units
I_{FAV}	Max. averaged fwd. current, R-load, $T_A = 50^\circ\text{C}^{(1)}$	10	A
I_{FRM}	Repetitive peak forward current $f > 15\text{ Hz}^{(1)}$	80	A
I_{FSM}	Peak forward surge current 50 Hz half sinus-wave $^{(3)}$	400	A
i^2t	Rating for fusing, $t < 10\text{ ms}^{(3)}$	800	A^2s
R_{thA}	Max. thermal resistance junction to ambient $^{(1)}$		K/W
R_{thL}	Max. thermal resistance junction to terminals $^{(4)}$	3	K/W
T_j	Operating junction temperature	-50...+175 ($T_j \leq 200^\circ\text{C}^{(5)}$)	$^\circ\text{C}$
T_s	Storage temperature	-50...+175	$^\circ\text{C}$

Characteristics		$T_A = 25^\circ\text{C}$, unless otherwise specified	
Symbol	Conditions	Values	Units
I_R	Maximum leakage current, $T_j = 25^\circ\text{C}$; $V_R = V_{RRM}$	<25	μA
	$T_j = ^\circ\text{C}$; $V_R = V_{RRM}$		
C_j	Typical junction capacitance (at MHz and applied reverse voltage of V)	-	pF
Q_{rr}	Reverse recovery charge ($U_R = V$; $I_F = A$; $dI_F/dt = A/\text{ms}$)	-	μC
E_{RSM}	Non repetitive peak reverse avalanche energy ($I_R = \text{mA}$; $T_j = ^\circ\text{C}$; inductive load switched off)	-	mJ

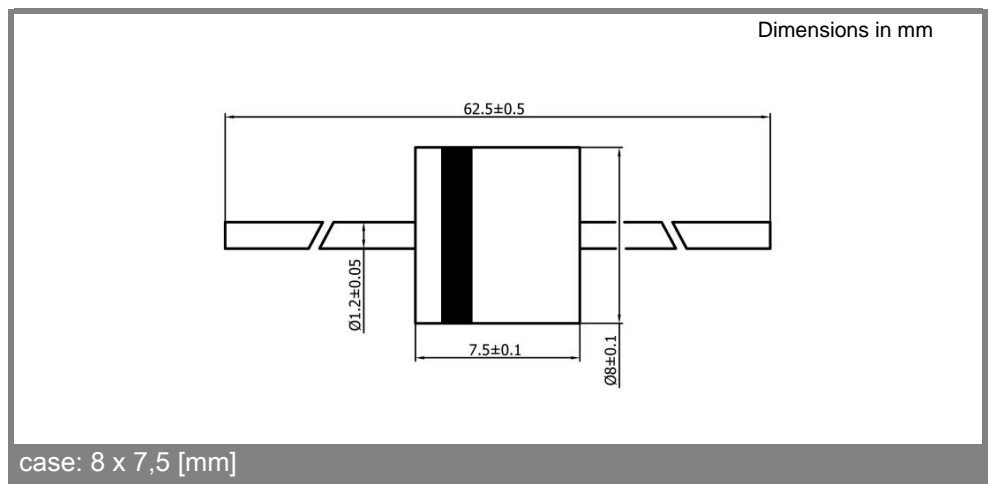

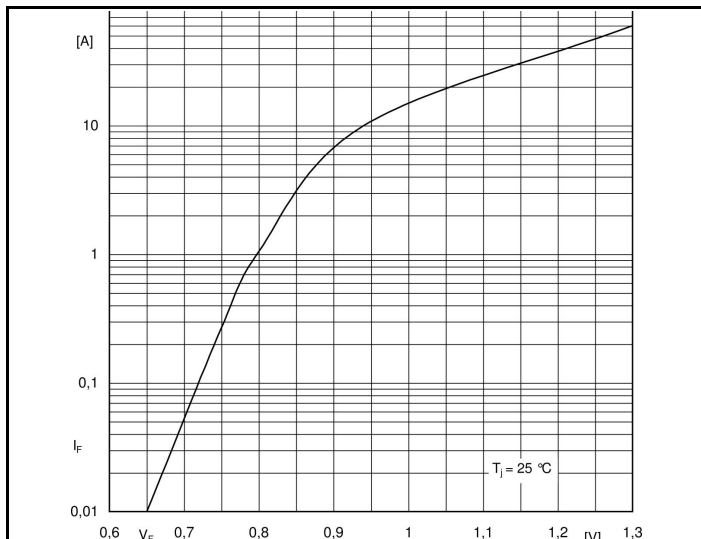

Fig. 1 Forward characteristic (typical values)

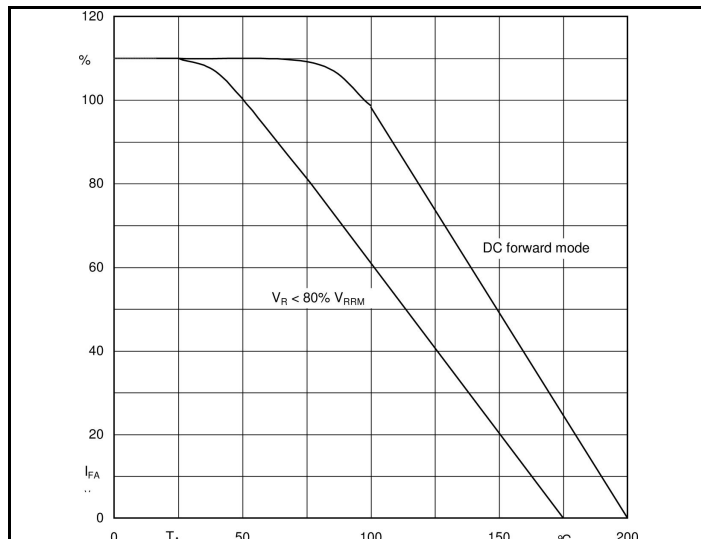

Fig. 2 Rated forward current vs. ambient temperature ¹⁾

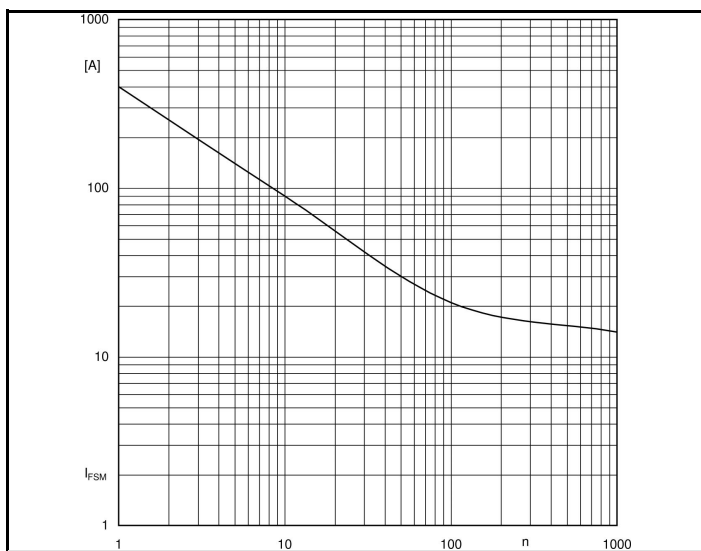

Fig. 3 I_{FSM} current versus number of cycles at 50 Hz

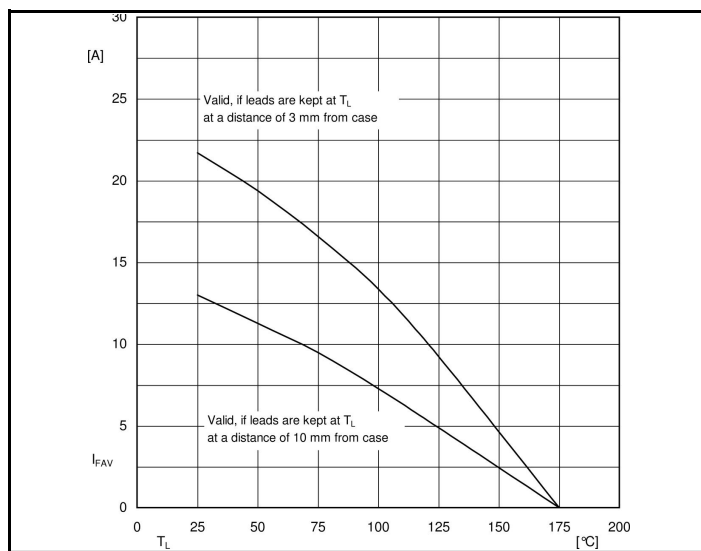

Fig. 4 Maximum Average Forward Current

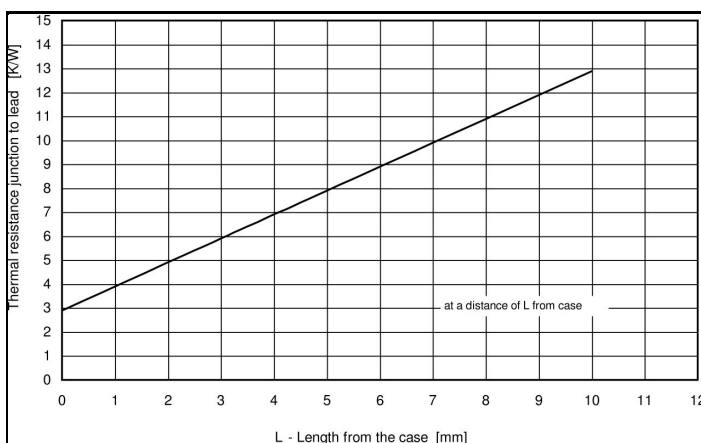

Fig. 5 Thermal resistance versus dimension from case