

Maximum Ratings

Symbol	Conditions	Values	Units
$V_{CEV_{sus}}$	$I_C = 1 A, V_{BE} = -2 V$	1000	V
V_{CEV}	$V_{BE} = -2 V$	1000	V
V_{CBO}	$I_E = 0$	1000	V
V_{EBO}	$I_C = 0$	7	V
I_C	D. C.	100	A
I_{CM}	$t_p = 1 ms$	200	A
$I_F = -I_C$		100	A
I_B		5	A
P_{tot}	$T_{case} = 25 °C$; per darlington	800	W
T_{vj}		-40 ... +150	°C
T_{stg}		-40 ... +125	°C
V_{isol}	a. c. 50 Hz, r.m.s.	2500~	V

Thermal Characteristics

R_{thjc}	per darlington/per module	0,155/0,077	°C/W
R_{thjc}	per diode/per module	0,65/0,325	°C/W
R_{thch}	per 1/2 module/per module	0,075/0,038	°C/W

Electrical Characteristics¹⁾

		min.	typ.	max.	
I_{CEV}	$V_{CE} = V_{CEV}, V_{BE} = -2 V$			2	mA
I_{EBO}	$I_C = 0, V_{BE} = -7 V$			400	mA
$V_{CEsat}^{2)}$	$I_C = 100 A, I_B = 2 A$			2,5	V
$V_{BEsat}^{2)}$	$I_C = 100 A, I_B = 2 A$			3,5	V
$h_{21E}^{2)}$	$I_C = 100 A$	$V_{CE} = 2,8 V$	75		
		$V_{CE} = 5 V$	100		

Switching Characteristics for Resistive Load¹⁾

t_{on}	$I_C = 100 A$ $I_{B1} = -I_{B2} = 2 A$ $V_{CC} = 600 V$		3	µs
t_s			15	µs
t_f			3	µs

Inverse Diode Characteristics¹⁾

$V_F = -V_{CE}$	$I_F = -I_C = 100 A$			1,8	V
$I_{FSM} = -I_{Cp}$	$\sin 180°, 10 ms$	1000			A
I_{RM}	$I_F = -I_C = 100 A, -di_F/dt = 100 A/\mu s$ $V_{BE} = -3 V, V_R = V_{CE} = 400 V,$ $T_{vj} = 125 °C$		38		A
			19		µC

Mechanical Data

M_1	Case to heatsink	SI units	3	6	Nm
		US units	27	53	lb. in.
M_2	Busbars to terminals	SI units	2,5	5	Nm
		US units	22	44	lb. in.
w			420		g
Case	DB		D 14		
	DAL		D 39		

1) $T_{case} = 25 °C$ unless otherwise stated

2) $t_p \leq 300 \mu s, D \leq 1,5 \%$

SEMITRANS® 3 NPN Power Darlington Modules 100 A, 1000 V

SK 100 DB 100 D
SK 100 DAL 100 D

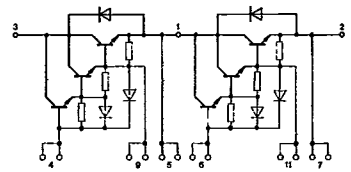
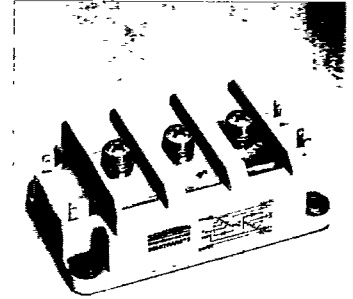

DB

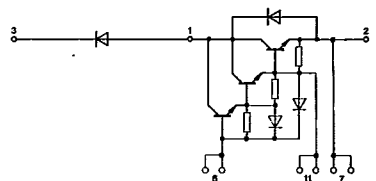

DAL

Features

- Isolated baseplate (ease of mounting of one or several modules on one heatsink)
- All electrical connections on top (ease of interconnecting of modules with busbars)
- Large clearances and creepage distances
- Parallel connected fast recovery inverse diode
- UL recognized, file no. 63 532

Typical Applications

- Uninterruptible power supplies (UPS)
- DC drives
- AC motor controls
- Brake choppers (DAL)

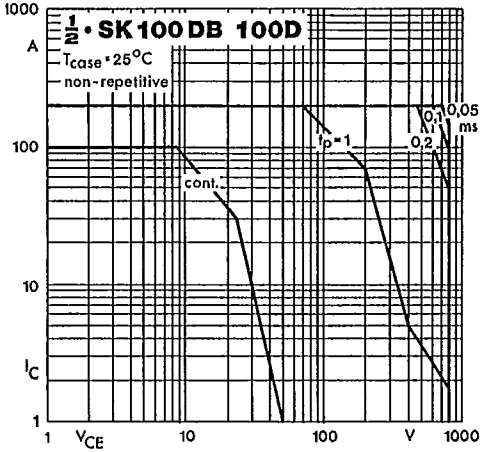

Fig. 1 Forward biased safe operating area (FBSOA)

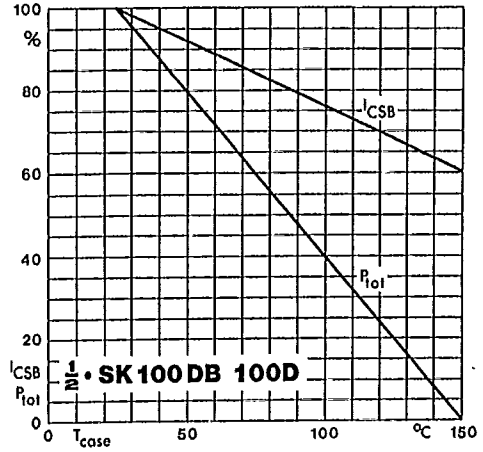

Fig. 2 Shifting the limits of the FBSOA with temperature

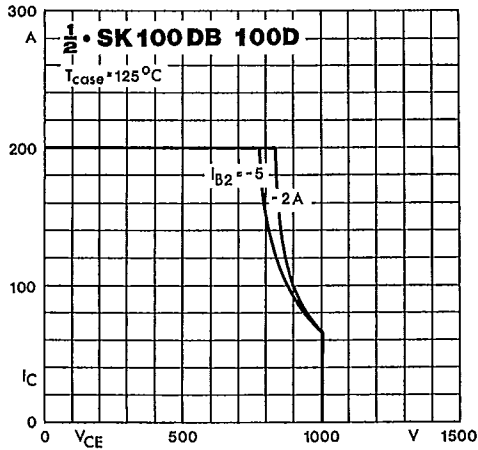

Fig. 3 Reverse biased safe operating area (RBSOA)

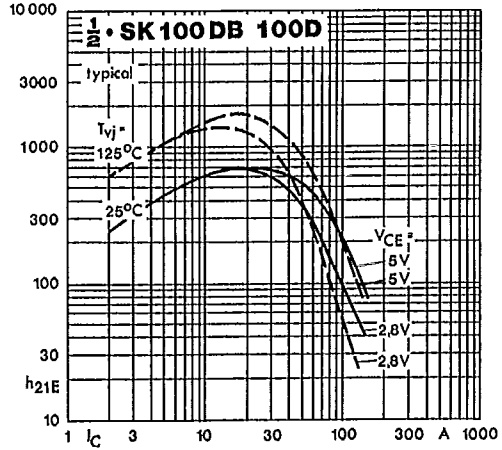

Fig. 4 Forward current transfer ratio vs. coll. current

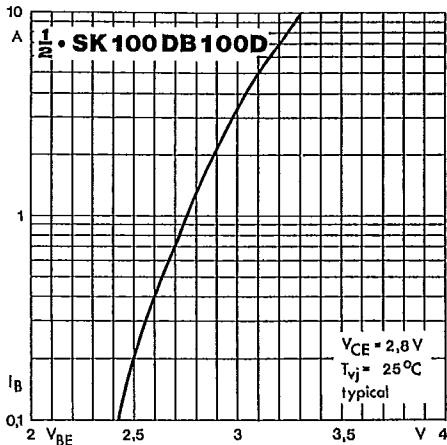

Fig. 5 Base current/voltage characteristic

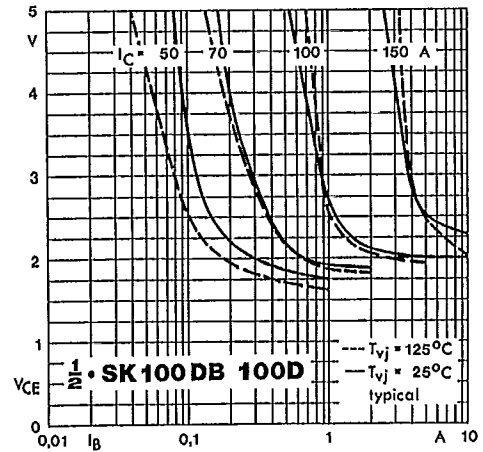

Fig. 6 Collector-emitter voltage vs. base current

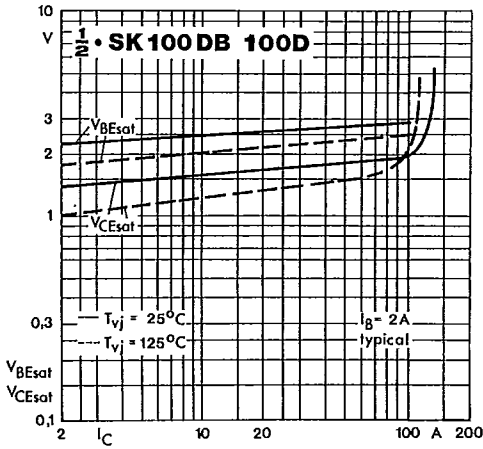

Fig. 7 Saturation voltages vs. collector current

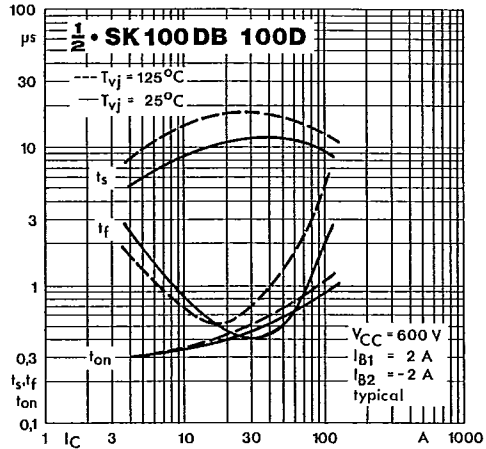

Fig. 8 Switching times vs. collector current

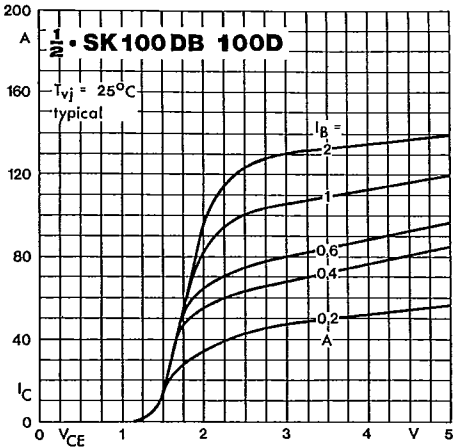

Fig. 9 Collector current/voltage characteristics

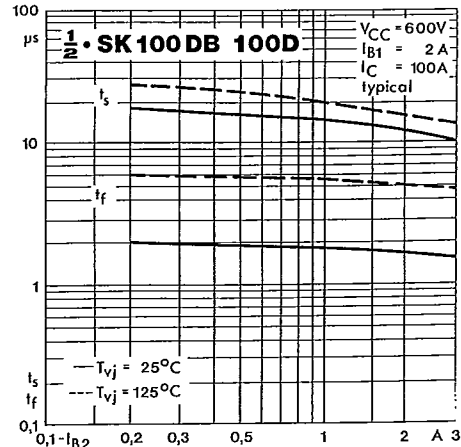

Fig. 10 Turn-off times vs. negative base current

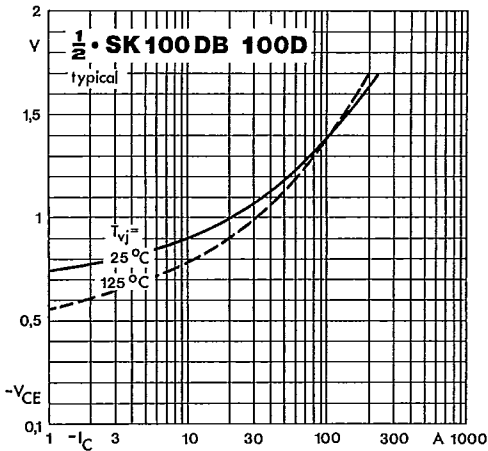

Fig. 11 Inverse diode forward characteristics

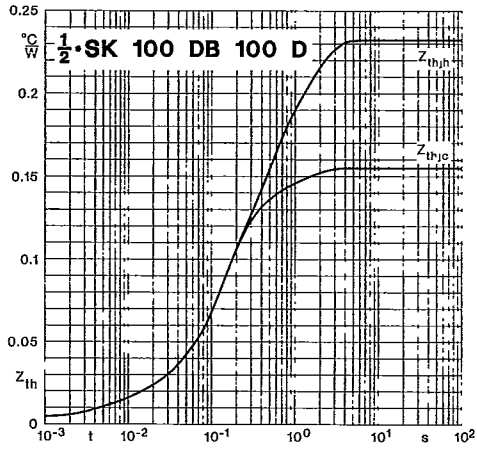

Fig. 12 Transient thermal impedance vs. time

SK 100 DB 100 D

SEMISTRANS® 3

Case D 14

UL recognized, file no. 63 532

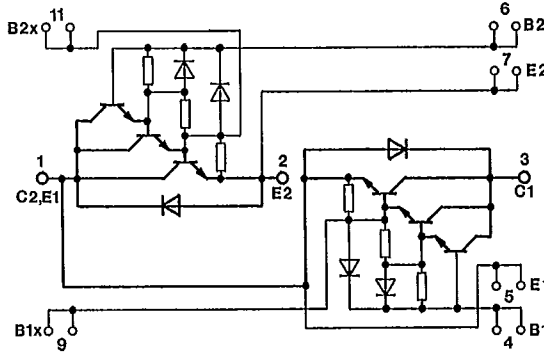
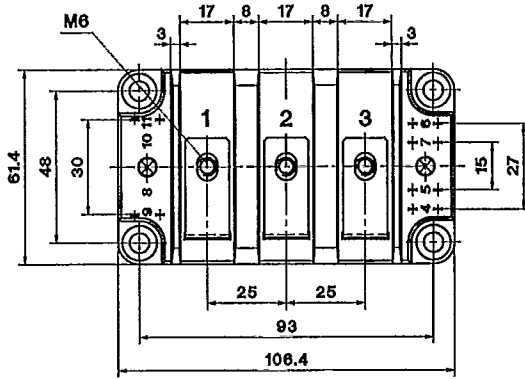
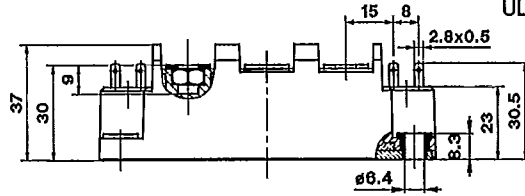

Dimensions in mm

SK 100 DAL 100 D

SEMISTRANS® 3

Case D 39

UL recognized, file no. 63 532

