



SEMITOP[®] 2

IGBT Module

SK25GB12T4

Target Data

Features

- One screw mounting module
- Trench4 IGBT technology
- CAL4 technology FWD

Typical Applications*

Remarks

- $V_{CE,sat}$, V_F = chip level value

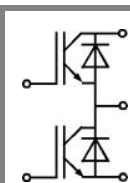

GB

Absolute Maximum Ratings		$T_s = 25\text{ °C}$, unless otherwise specified		
Symbol	Conditions	Values		Units
IGBT				
V_{CES}	$T_j = 25\text{ °C}$	1200		V
I_C	$T_j = 175\text{ °C}$	$T_s = 25\text{ °C}$	37	A
		$T_s = 70\text{ °C}$	30	A
I_{CRM}	$I_{CRM} = 3 \times I_{Cnom}$	75		A
V_{GES}		± 20		V
t_{psc}	$V_{CC} = 800\text{ V}$; $V_{GE} \leq 15\text{ V}$; $T_j = 150\text{ °C}$ $V_{CES} < 1200\text{ V}$	10		µs
Inverse Diode				
I_F	$T_j = 175\text{ °C}$	$T_s = 25\text{ °C}$	30	A
		$T_s = 70\text{ °C}$	25	A
I_{FRM}	$I_{FRM} = 3 \times I_{Fnom}$	75		A
I_{FSM}	$t_p = 10\text{ ms}$; half sine wave $T_j = 150\text{ °C}$	160		A
Module				
$I_{t(RMS)}$				A
T_{vj}		-40 ... +175		°C
T_{stg}		-40 ... +125		°C
V_{isol}	AC, 1 min.	2500		V

Characteristics		$T_s = 25\text{ °C}$, unless otherwise specified			
Symbol	Conditions	min.	typ.	max.	Units
IGBT					
$V_{GE(th)}$	$V_{GE} = V_{CE}$, $I_C = 0,85\text{ mA}$	5	5,8	6,5	V
I_{CES}	$V_{GE} = 0\text{ V}$, $V_{CE} = V_{CES}$	$T_j = 25\text{ °C}$	0,0024		mA
		$T_j = 125\text{ °C}$			mA
I_{GES}	$V_{CE} = 0\text{ V}$, $V_{GE} = 20\text{ V}$	$T_j = 25\text{ °C}$	120		nA
		$T_j = 125\text{ °C}$			nA
V_{CE0}		$T_j = 25\text{ °C}$	1,1	1,3	V
		$T_j = 150\text{ °C}$	1	1,2	V
r_{CE}	$V_{GE} = 15\text{ V}$	$T_j = 25\text{ °C}$	30		mΩ
		$T_j = 150\text{ °C}$	50		mΩ
$V_{CE(sat)}$	$I_{Cnom} = 25\text{ A}$, $V_{GE} = 15\text{ V}$	$T_j = 25\text{ °C}_{chiplev.}$	1,85	2,05	V
		$T_j = 150\text{ °C}_{chiplev.}$	2,25	2,45	V
C_{ies}	$V_{CE} = 25$, $V_{GE} = 0\text{ V}$	1,43		nF	
C_{oes}		0,115		nF	
C_{res}		0,085		nF	
Q_G	$V_{GE} = -7\text{ V} \dots +15\text{ V}$	137,5		nC	
$t_{d(on)}$	$R_{Gon} = 19\text{ } \Omega$ $di/dt = 2825\text{ A}/\mu\text{s}$	$V_{CC} = 600\text{ V}$ $I_C = 25\text{ A}$	22		ns
t_r			19,5		ns
E_{on}			2,27		mJ
$t_{d(off)}$	$R_{Goff} = 19\text{ } \Omega$ $di/dt = 2825\text{ A}/\mu\text{s}$	$T_j = 150\text{ °C}$ $V_{GE} = -7/+15\text{ V}$	288		ns
t_f			77,5		ns
E_{off}			2,7		mJ
$R_{th(j-s)}$	per IGBT	1,31		K/W	

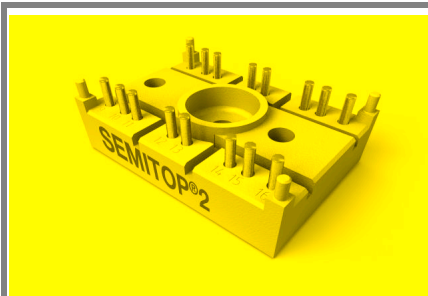

SEMITOP® 2

IGBT Module

SK25GB12T4

Target Data

Features

- One screw mounting module
- Trench4 IGBT technology
- CAL4 technology FWD

Typical Applications*

Remarks

- $V_{CE,sat}$, V_F = chip level value

Characteristics

Symbol	Conditions	min.	typ.	max.	Units	
Inverse Diode						
$V_F = V_{EC}$	$I_{Fnom} = 25 \text{ A}; V_{GE} = 0 \text{ V}$		$T_j = 25 \text{ }^\circ\text{C}_{\text{chiplev.}}$	2,4	2,62	V
			$T_j = 150 \text{ }^\circ\text{C}_{\text{chiplev.}}$	2,45	2,8	V
V_{F0}			$T_j = 25 \text{ }^\circ\text{C}$	1,3	1,5	V
			$T_j = 150 \text{ }^\circ\text{C}$	0,9	1,1	V
r_F			$T_j = 25 \text{ }^\circ\text{C}$	44	45	mΩ
			$T_j = 150 \text{ }^\circ\text{C}$	62	68	mΩ
I_{RRM}	$I_F = 25 \text{ A}$	$T_j = 150 \text{ }^\circ\text{C}$		31,5	A	
Q_{rr}	$di/dt = 2825 \text{ A}/\mu\text{s}$			1,15	μC	
E_{rr}	$V_{CC} = 600\text{V}$			1,28	mJ	
$R_{th(j-s)D}$	per diode			1,91	K/W	
M_s	to heat sink		2,25	2,5	Nm	
w				30	g	

This is an electrostatic discharge sensitive device (ESDS), international standard IEC 60747-1, Chapter IX.

* The specifications of our components may not be considered as an assurance of component characteristics. Components have to be tested for the respective application. Adjustments may be necessary. The use of SEMIKRON products in life support appliances and systems is subject to prior specification and written approval by SEMIKRON. We therefore strongly recommend prior consultation of our personal.



GB

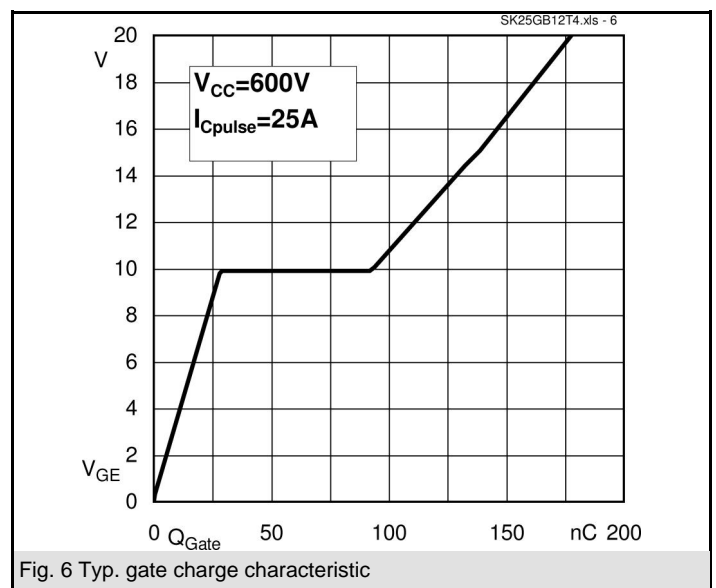
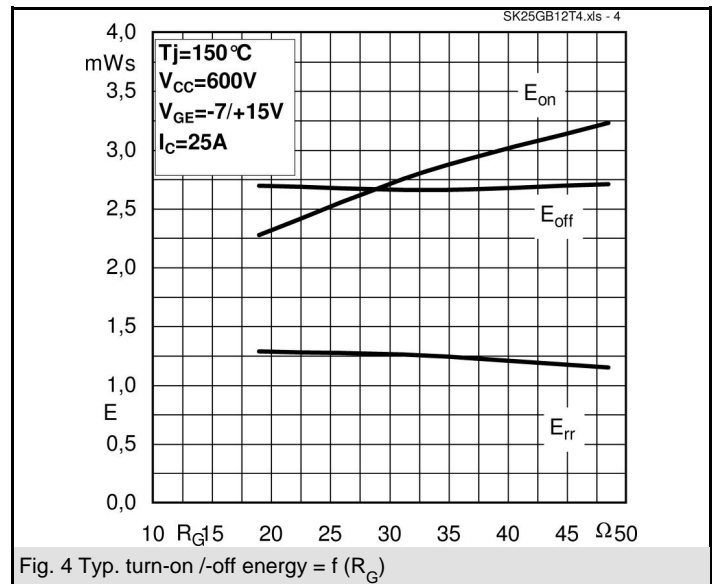
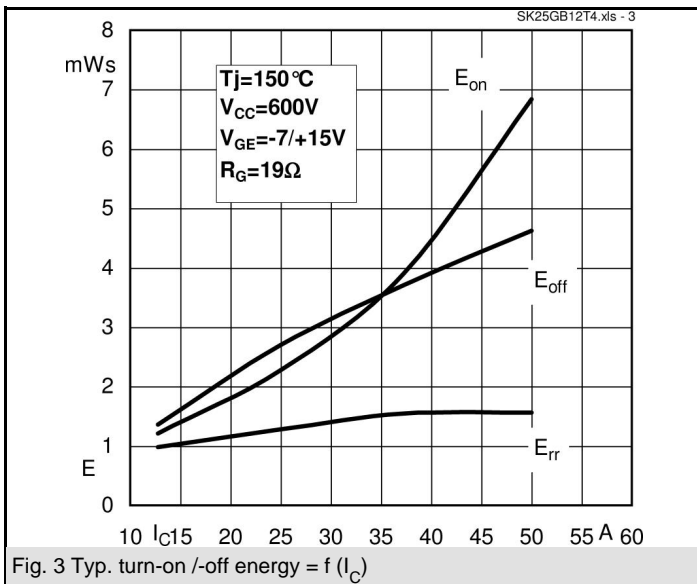
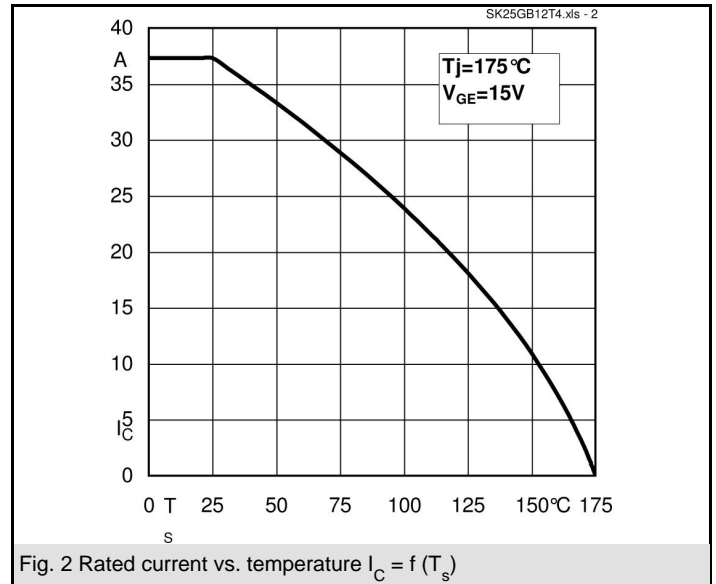
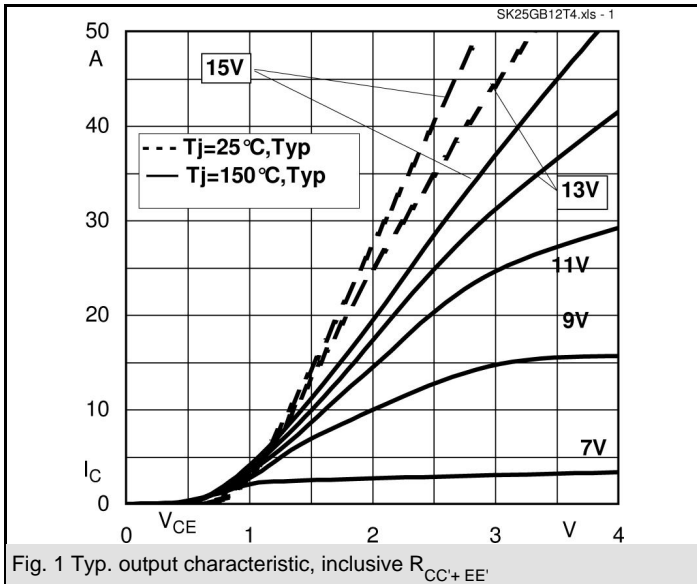

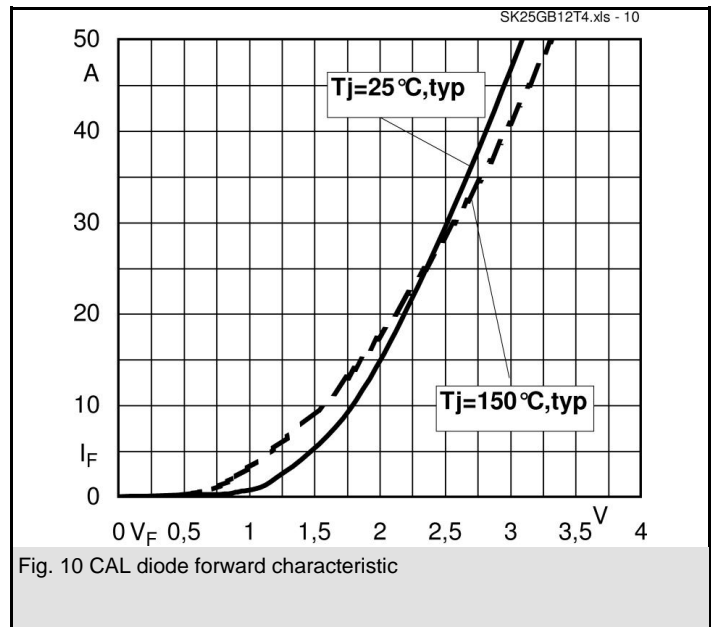
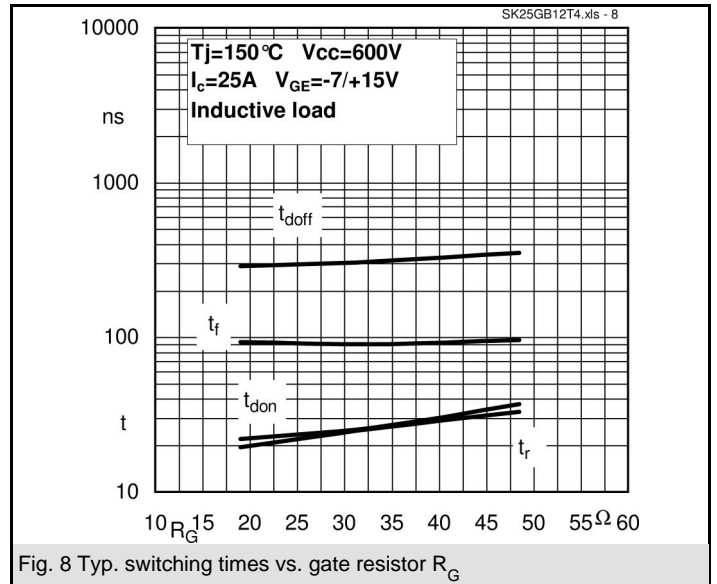
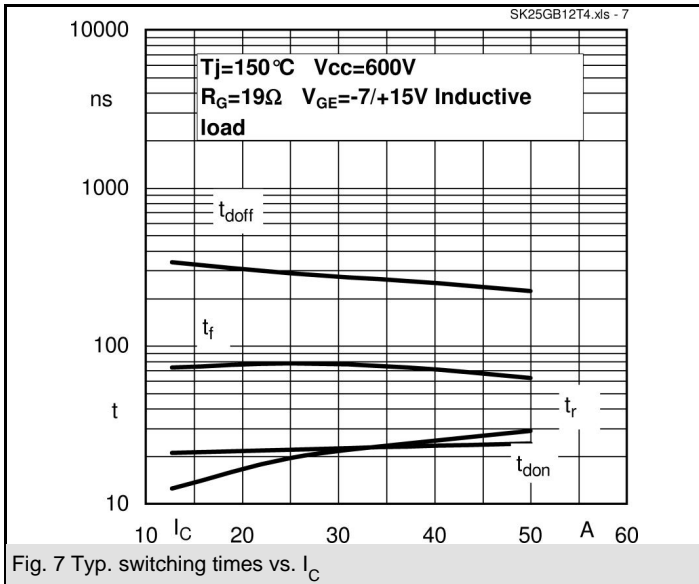

SK25GB12T4

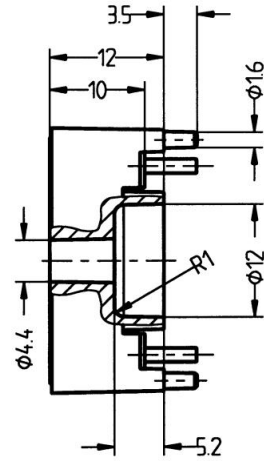
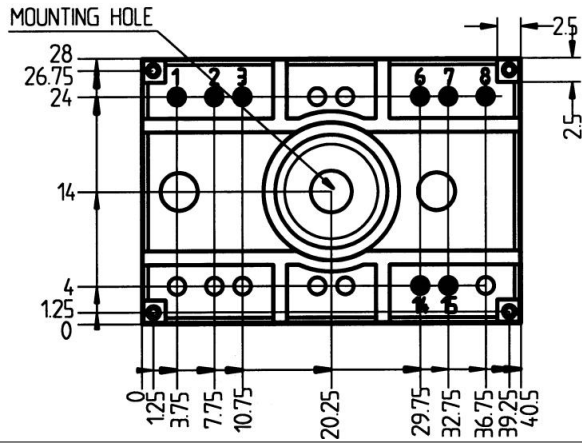
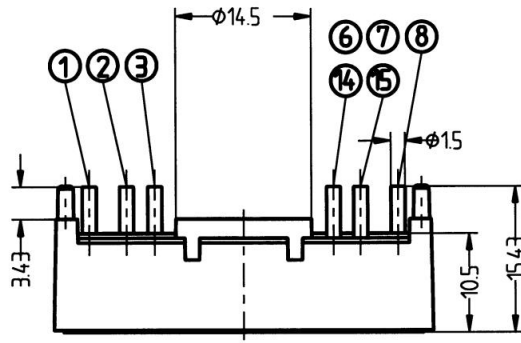

Case T32 (Suggested hole diameter for solder pins and plastic mounting pins: 2mm)

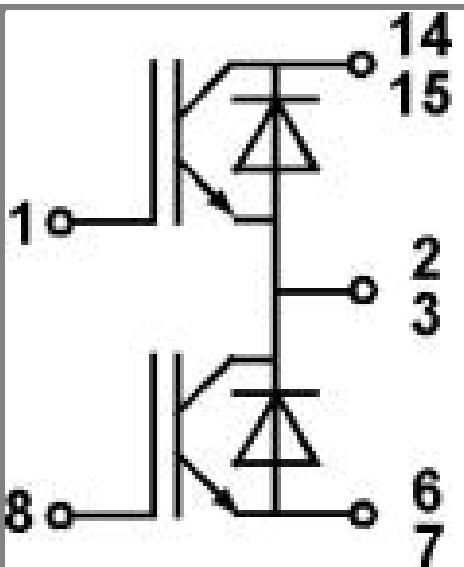

Case T 32

GB