

SK 45 KQ

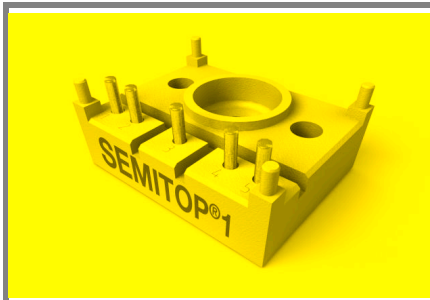

SEMITOP® 1

Antiparallel Thyristor Module

SK 45 KQ

Preliminary Data

Features

- Compact Design
- One screw mounting
- Heat transfer and isolation through direct copper bonded aluminium oxide ceramic (DBC)
- Glass passivated thyristor chips
- Up to 1600V reverse voltage
- UL recognized, file no. E 63 532

Typical Applications*

- Soft starters
- Light control (studios, theaters...)
- Temperature control

V_{RSM} V	V_{RRM}, V_{DRM} V	$I_{RMS} = 47 \text{ A A (full conduction)}$ ($T_s = 85 \text{ °C}$)
900	800	SK 45 KQ 08
1300	1200	SK 45 KQ 12
1700	1600	SK 45 KQ 16

Symbol	Conditions	Values	Units
I_{RMS}	W1C ; sin. 180° ; $T_s = 100 \text{ °C}$	33	A
	W1C ; sin. 180° ; $T_s = 85 \text{ °C}$	47	A
I_{TSM}	$T_{vj} = 25 \text{ °C}$; 10 ms	450	A
	$T_{vj} = 125 \text{ °C}$; 10 ms	380	A
i^2t	$T_{vj} = 25 \text{ °C}$; 8,3...10 ms	1000	A ² s
	$T_{vj} = 125 \text{ °C}$; 8,3...10 ms	720	A ² s
V_T	$T_{vj} = 25 \text{ °C}$, $I_T = 75 \text{ A}$	max. 1,9	V
$V_{T(TO)}$	$T_{vj} = 125 \text{ °C}$	max. 1	V
r_T	$T_{vj} = 125 \text{ °C}$	max. 10	mΩ
I_{DD}, I_{RD}	$T_{vj} = 25 \text{ °C}$, $V_{RD} = V_{RRM}$	max. 0,5	mA
	$T_{vj} = 125 \text{ °C}$, $V_{RD} = V_{RRM}$	max. 10	mA
t_{gd}	$T_{vj} = 25 \text{ °C}$, $I_G = 1 \text{ A}$; $di_G/dt = 1 \text{ A}/\mu\text{s}$	1	μs
t_{gr}	$V_D = 0,67 * V_{DRM}$	2	μs
$(dv/dt)_{cr}$	$T_{vj} = 125 \text{ °C}$	1000	V/μs
$(di/dt)_{cr}$	$T_{vj} = 125 \text{ °C}$; $f = 50...60 \text{ Hz}$	50	A/μs
t_q	$T_{vj} = 125 \text{ °C}$; typ.	120	μs
I_H	$T_{vj} = 25 \text{ °C}$; typ. / max.	80 / 150	mA
I_L	$T_{vj} = 25 \text{ °C}$; $R_G = 33 \text{ Ω}$; typ. / max.	150 / 300	mA
V_{GT}	$T_{vj} = 25 \text{ °C}$; d.c.	min. 3	V
I_{GT}	$T_{vj} = 25 \text{ °C}$; d.c.	min. 100	mA
V_{GD}	$T_{vj} = 125 \text{ °C}$; d.c.	max. 0,25	V
I_{GD}	$T_{vj} = 125 \text{ °C}$; d.c.	max. 3	mA
$R_{th(j-s)}$	cont. per thyristor	1,2	K/W
	sin 180° per thyristor	1,24	K/W
$R_{th(j-s)}$	cont. per W1C	0,6	K/W
	sin 180° per W1C	0,62	K/W
T_{vj}		-40 ... +125	°C
T_{stg}		-40 ... +125	°C
T_{solder}	terminals, 10s	260	°C
V_{isol}	a. c. 50 Hz; r.m.s.; 1 s / 1 min.	3000 / 2500	V~
M_s	Mounting torque to heatsink	1,5	Nm
M_t			Nm
a			m/s ²
m		13	g
Case	SEMITOP® 1	T 1	

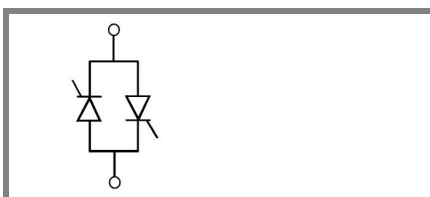

KQ

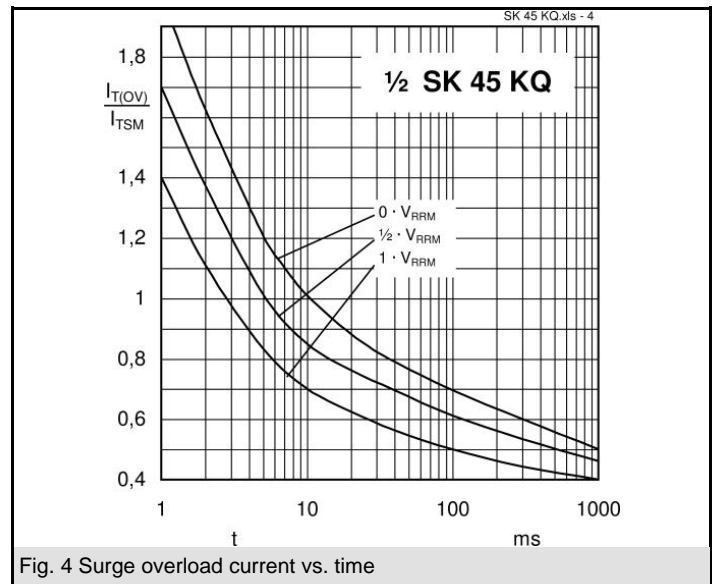
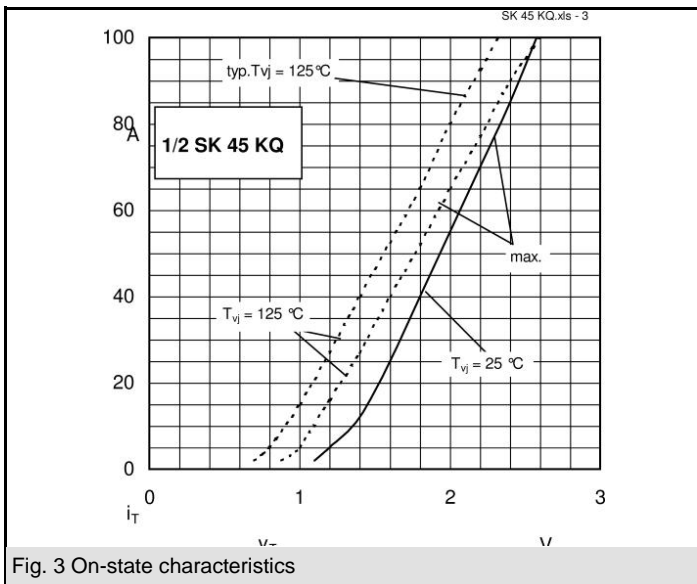
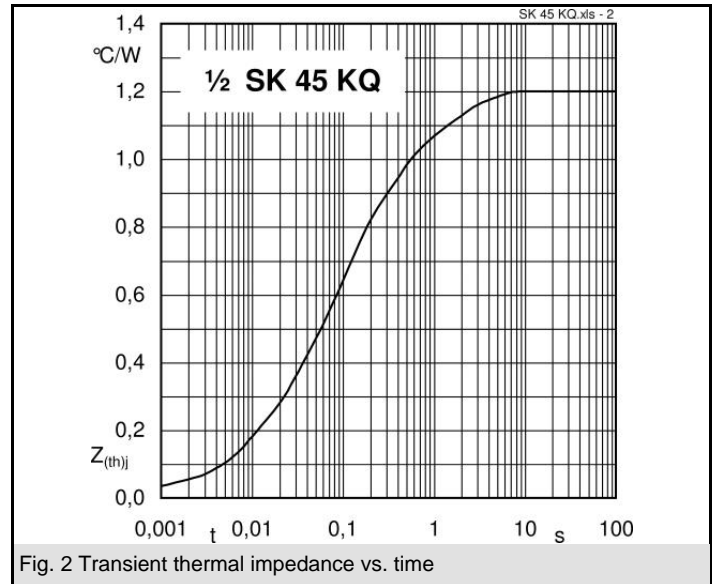
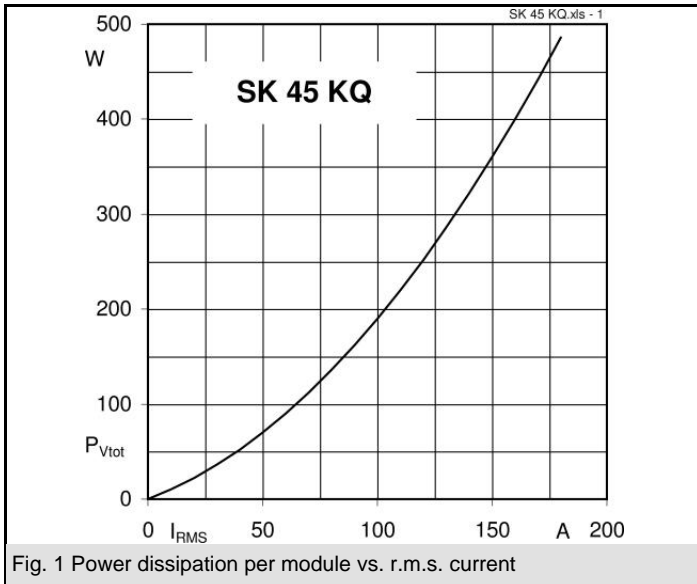

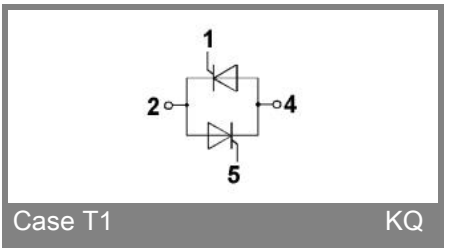
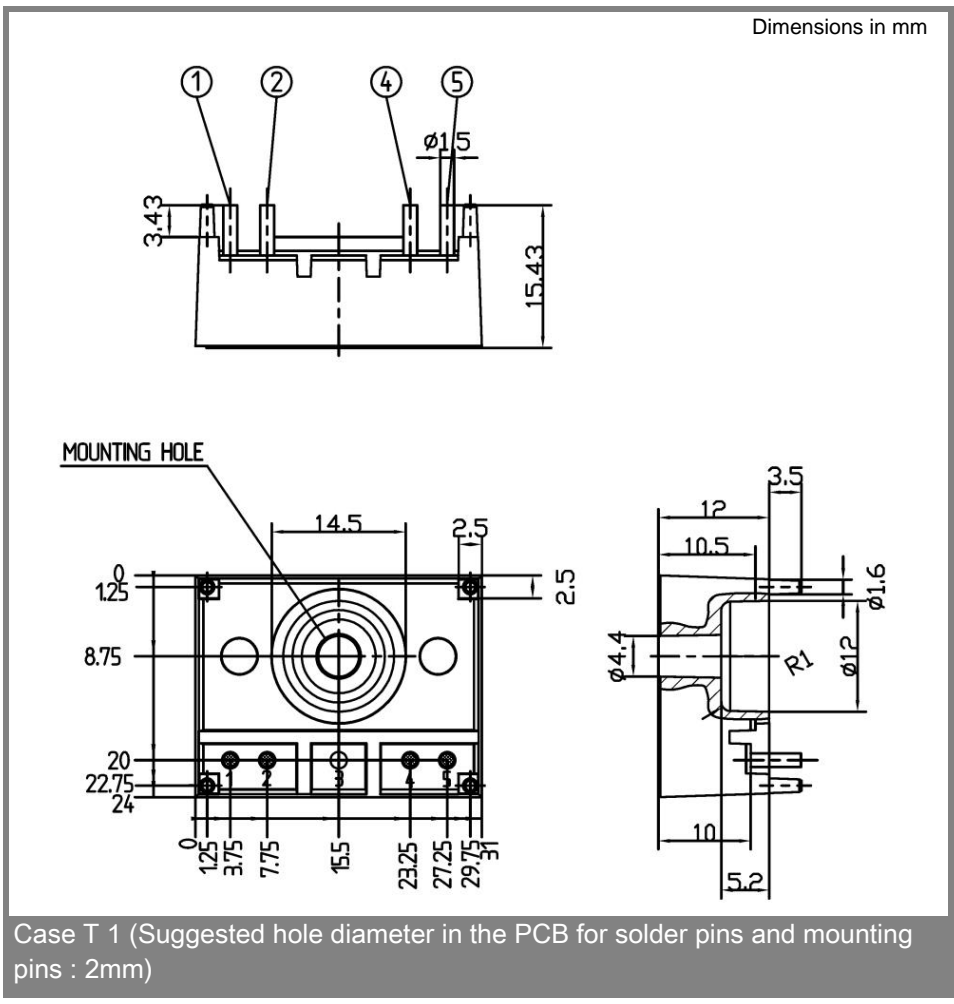
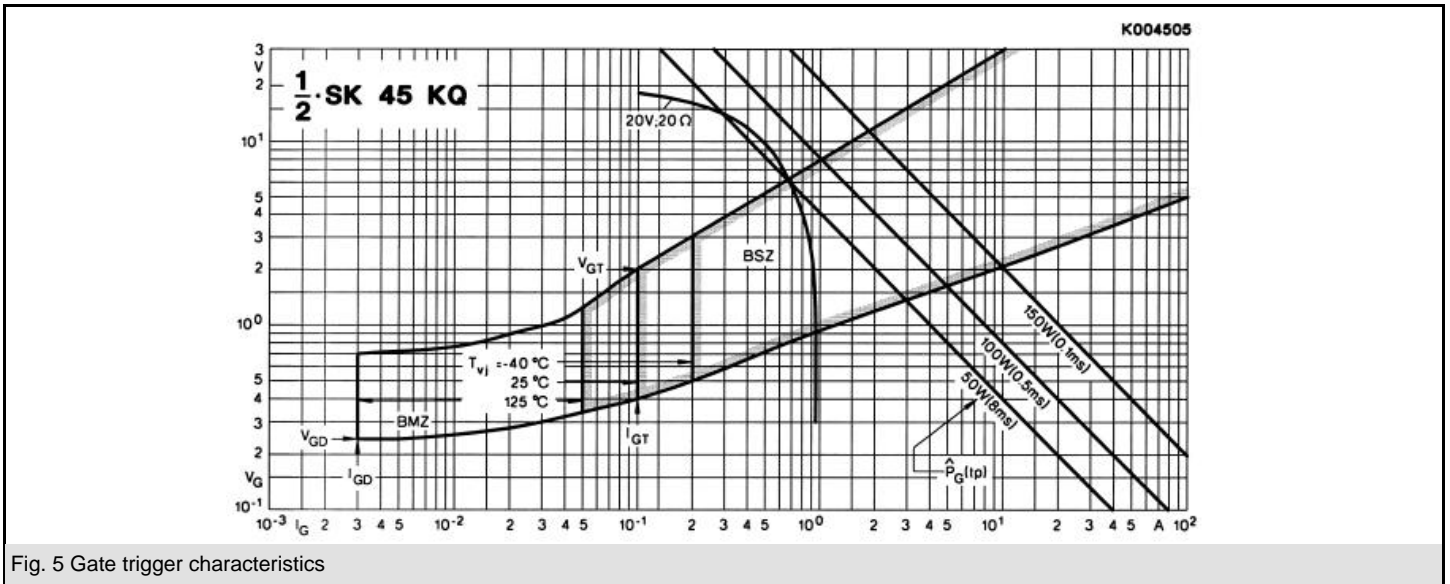

* The specifications of our components may not be considered as an assurance of component characteristics. Components have to be tested for the respective application. Adjustments may be necessary. The use of SEMIKRON products in life support appliances and systems is subject to prior specification and written approval by SEMIKRON. We therefore strongly recommend prior consultation of our personal.