

SK 50 DGDL 066 T

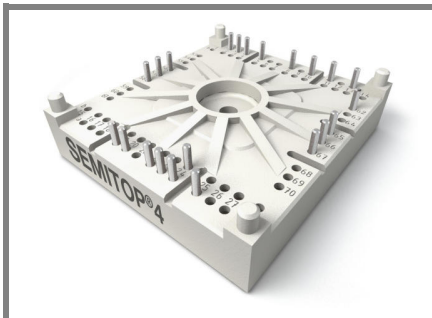

SEMITOP®4

**3-phase bridge rectifier +
brake chopper + 3-phase
bridge inverter**
SK 50 DGDL 066 T

Preliminary Data

Features

- One screw mounting module
- Fully compatible with SEMITOP®1,2,3
- Improved thermal performances by aluminium oxide substrate
- Trench IGBT technology
- CAL technology free-wheeling diode
- Integrated NTC temperature sensor

Typical Applications*

- Inverter up to 12,5 kVA
- Typical motor power 5,5 kW

Remarks

- $V_{CE,sat}$, V_F = chip level value

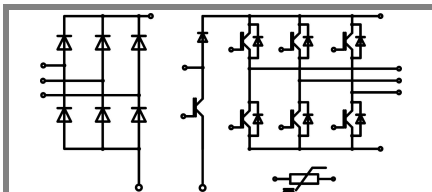

DGDL - T

Absolute Maximum Ratings		$T_s = 25^\circ\text{C}$, unless otherwise specified	
Symbol	Conditions	Values	Units
IGBT - Inverter, Chopper			
V_{CES}		600	V
I_C	$T_s = 25 (70)^\circ\text{C}$, $T_j = 175^\circ\text{C}$	69 (55)	A
I_C	$T_s = 25 (70)^\circ\text{C}$, $T_j = 150^\circ\text{C}$	62 (47)	A
I_{CRM}	$I_{CRM} = 2 \times I_{Cnom}$, $t_p = 1 \text{ ms}$	100	A
V_{GES}		± 20	V
T_j		-40 ... + 175	$^\circ\text{C}$
Diode - Inverter, Chopper			
I_F	$T_s = 25 (70)^\circ\text{C}$, $T_j = 150^\circ\text{C}$	48 (35)	A
I_F	$T_s = 25 (70)^\circ\text{C}$, $T_j = 175^\circ\text{C}$	54 (42)	A
I_{FRM}	$I_{FRM} = 2 \times I_{Fnom}$, $t_p = 1 \text{ ms}$	56	A
Diode - Rectifier			
V_{RRM}		800	V
I_F	$T_s = 70^\circ\text{C}$	35	A
I_{FSM}	$t_p = 10 \text{ ms}$, $\sin 180^\circ$, $T_j = 25^\circ\text{C}$	370	A
i^2t	$t_p = 10 \text{ ms}$, $\sin 180^\circ$, $T_j = 25^\circ\text{C}$	680	A^2s
T_j		-40 ... + 175	$^\circ\text{C}$
T_{sol}	Terminals, 10 s	260	$^\circ\text{C}$
T_{stg}		-40 ... + 125	$^\circ\text{C}$
V_{isol}	AC, 1 min.	2500	V

Characteristics		$T_s = 25^\circ\text{C}$, unless otherwise specified			
Symbol	Conditions	min.	typ.	max.	Units
IGBT - Inverter, Chopper					
$V_{CE(sat)}$	$I_{Cnom} = 50 \text{ A}$, $T_j = 25 (150)^\circ\text{C}$	1,05	1,45 (1,65)	1,85 (2,05)	V
$V_{GE(th)}$	$V_{GE} = V_{CE}$, $I_C = 0,8 \text{ mA}$	5	5,8	6,5	V
$V_{CE(TO)}$	$T_j = 25 (150)^\circ\text{C}$		0,9 (0,8)	1,1 (1)	V
r_{CE}	$T_j = 25 (150)^\circ\text{C}$		11 (17)	15 (21)	$\text{m}\Omega$
C_{ies}	$V_{CE} = 25 \text{ V}$, $V_{GE} = 0 \text{ V}$, $f = 1 \text{ MHz}$		3,1		nF
C_{oes}	$V_{CE} = 25 \text{ V}$, $V_{GE} = 0 \text{ V}$, $f = 1 \text{ MHz}$		0,2		nF
C_{res}	$V_{CE} = 25 \text{ V}$, $V_{GE} = 0 \text{ V}$, $f = 1 \text{ MHz}$		0,093		nF
$R_{th(j-s)}$	per IGBT		0,95		K/W
$t_{d(on)}$	under following conditions		28		ns
t_r	$V_{CC} = 300 \text{ V}$, $V_{GE} = -7 / + 15 \text{ V}$		32		ns
$t_{d(off)}$	$I_{Cnom} = 50 \text{ A}$, $T_j = 150^\circ\text{C}$		301		ns
t_f	$R_{Gon} = R_{Goff} = 16 \Omega$		45		ns
$E_{on} (E_{off})$	inductive load		2,2 (1,74)		mJ
Diode - Inverter, Chopper					
$V_F = V_{EC}$	$I_F = 37 \text{ A}$, $T_j = 25 (150)^\circ\text{C}$		1,35 (1,31)		V
$V_{(TO)}$	$T_j = 25 (150)^\circ\text{C}$		(0,85)		V
r_T	$T_j = 25 (150)^\circ\text{C}$		(12,6)		$\text{m}\Omega$
$R_{th(j-s)}$	per diode		1,6		K/W
I_{RRM}	under following conditions		44		A
Q_{rr}	$I_{Fnom} = 50 \text{ A}$, $V_R = 300 \text{ V}$		4,8		μC
E_{rr}	$V_{GE} = 0 \text{ V}$, $T_j = 150^\circ\text{C}$		0,73		mJ
	$di_F/dt = 2438 \text{ A}/\mu\text{s}$				
Diode - Rectifier					
V_F	$I_{Fnom} = 25 \text{ A}$, $T_j = 25^\circ\text{C}$		1,1		V
$V_{(TO)}$	$T_j = 150^\circ\text{C}$		0,8		V
r_T	$T_j = 150^\circ\text{C}$		13		$\text{m}\Omega$
$R_{th(j-s)}$	per diode		1,5		K/W
Temperature Sensor					
R_{ts}	5 %, $T_r = 25 (100)^\circ\text{C}$		5000(493)		Ω
Mechanical Data					
w			60		g
M_s	Mounting torque	2,5		2,75	Nm

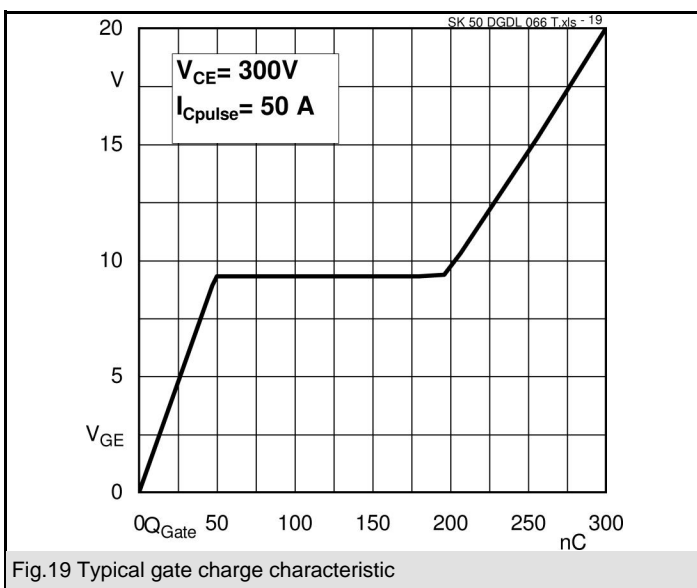
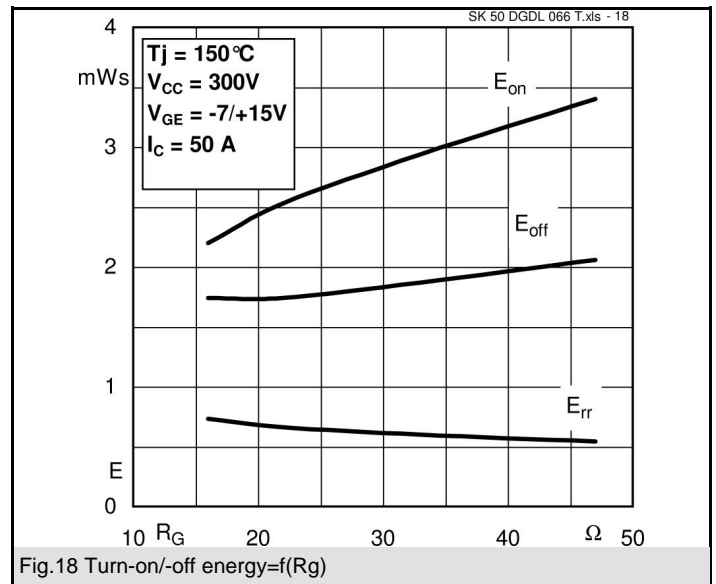
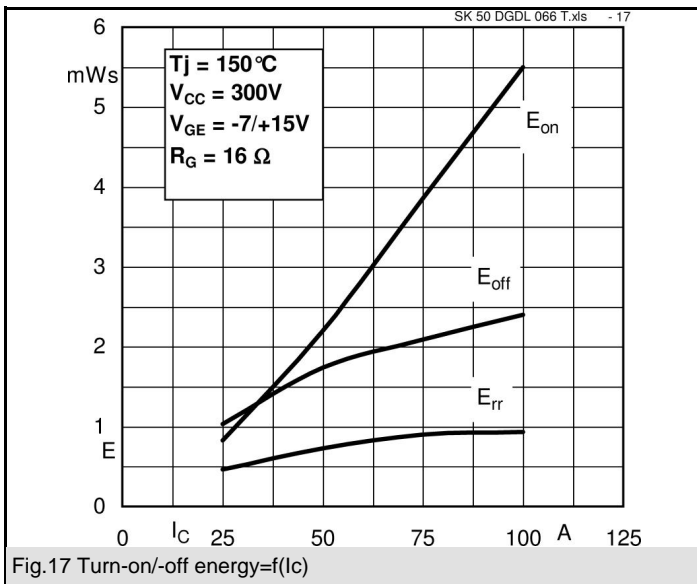
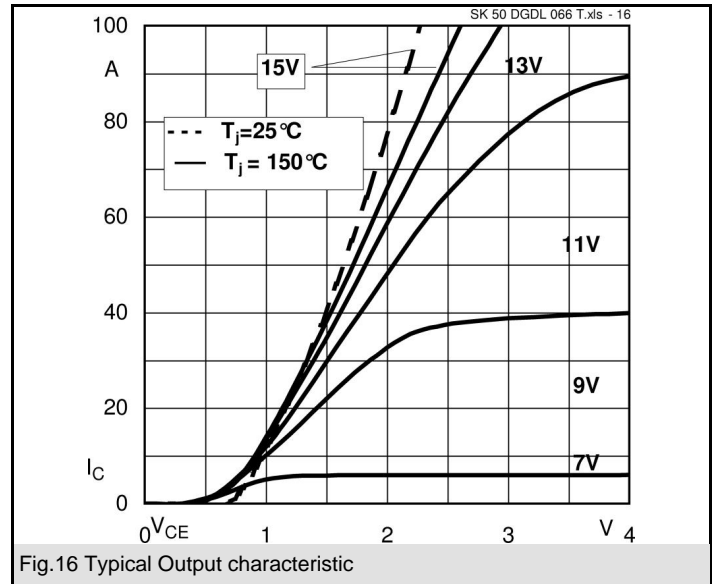
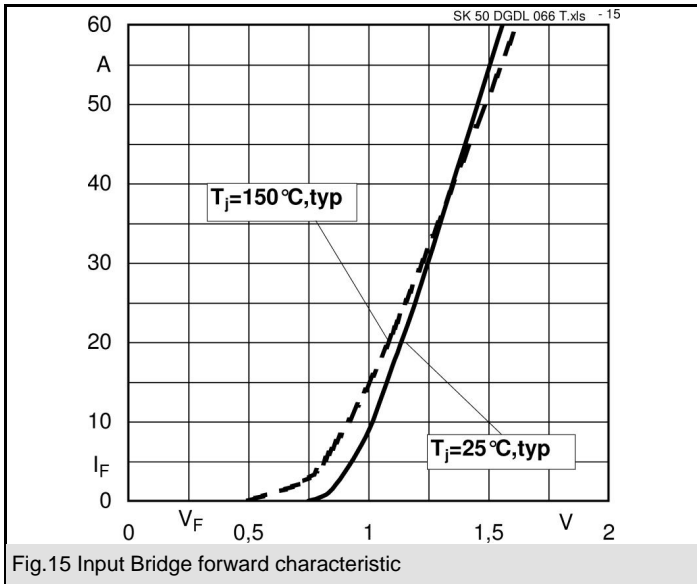

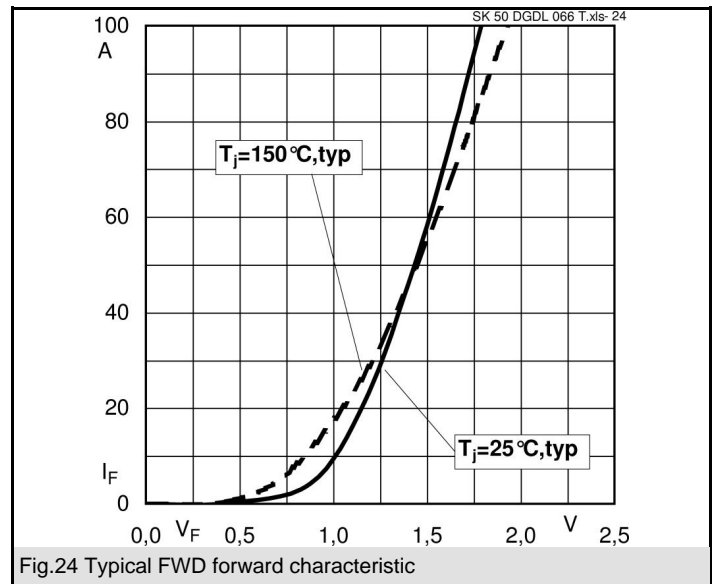
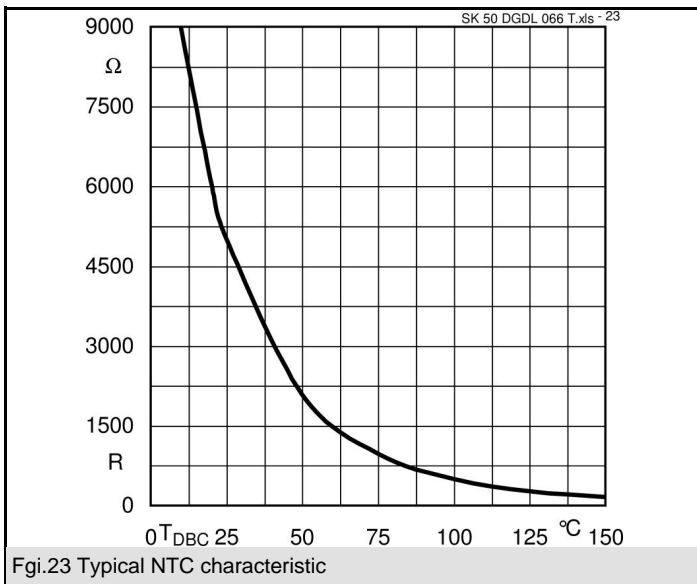
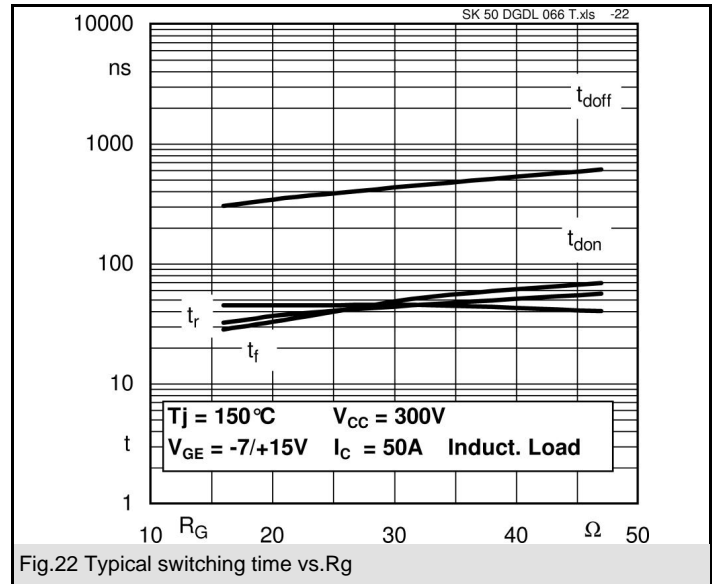
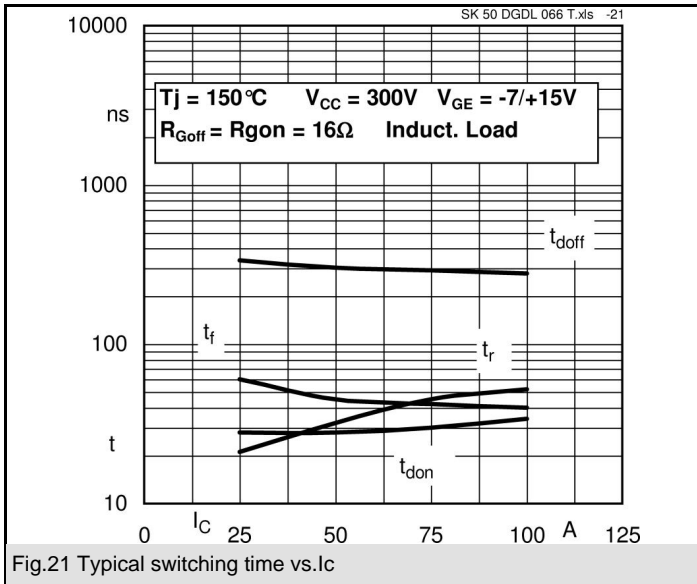

SK 50 DGDL 066 T

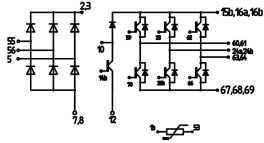

Case T 75
(pin without
letter refers
to row "a",
unless
otherwise
specified)

UL recognized
file no E 63 532

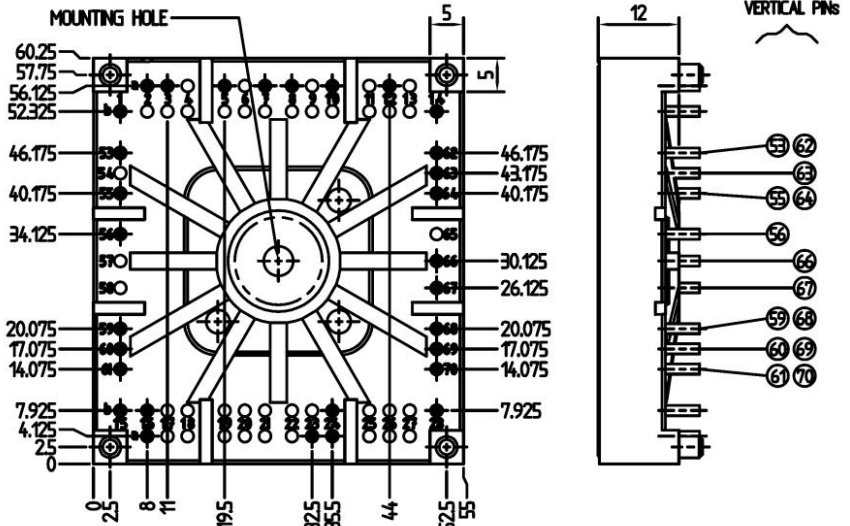
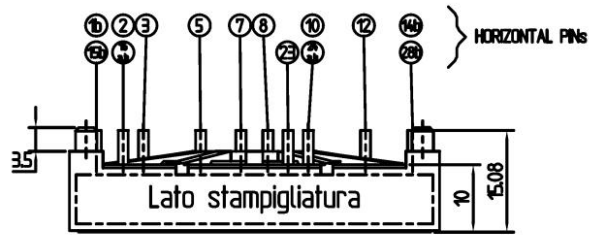

Case T 75 (Suggested hole diameter for the solder pins in the circuit board: 2mm.
Suggested hole diameter for the mounting pins in the circuit board: 3,6mm)

This is an electrostatic discharge sensitive device (ESDS), international standard IEC 60747-1, Chapter IX.

* The specifications of our components may not be considered as an assurance of component characteristics. Components have to be tested for the respective application. Adjustments may be necessary. The use of SEMIKRON products in life support appliances and systems is subject to prior specification and written approval by SEMIKRON. We therefore strongly recommend prior consultation of our personal.