



SEMITOP[®] 2

MOSFET Module

SK 85 MH 10 T

Preliminary Data

Features

- Compact design
- One screw mounting
- Heat transfer and isolation through direct copper bonding aluminium oxide ceramic (DBC)
- Trench-gate technology
- Short internal connections and low inductance case

Typical Applications*

- Low switched mode power supplies
- DC servo drives
- UPS

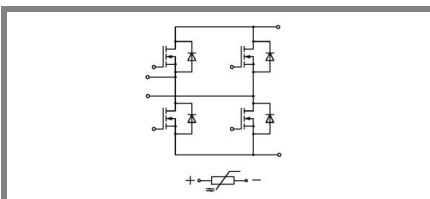

MH - T

Absolute Maximum Ratings		$T_s = 25\text{ }^\circ\text{C}$, unless otherwise specified	
Symbol	Conditions	Values	Units
MOSFET			
V_{DSS}		100	V
V_{GSS}		± 20	V
I_D	$T_s = 25\text{ (80) }^\circ\text{C}; 1)$	80 (60)	A
I_{DM}	$t_p < 1\text{ ms}; T_s = 80\text{ }^\circ\text{C}; 1)$	120	A
T_j		- 40 ... + 150	$^\circ\text{C}$
Inverse diode			
$I_F = -I_D$	$T_s = 25\text{ (80) }^\circ\text{C};$	80 (60)	A
$I_{FM} = -I_{DM}$	$t_p < 1\text{ ms}; T_s = 80\text{ () }^\circ\text{C};$	120	A
T_j		- 40 ... + 150	$^\circ\text{C}$
Freewheeling CAL diode			
$I_F = -I_D$	$T_s = \text{ }^\circ\text{C}$		A
T_j			$^\circ\text{C}$
T_{stg}		- 40 ... + 125	$^\circ\text{C}$
T_{sol}	Terminals, 10 s	260	$^\circ\text{C}$
V_{isol}	AC, 1 min (1s)	2500 / 3000	V

Characteristics		$T_s = 25\text{ }^\circ\text{C}$, unless otherwise specified			
Symbol	Conditions	min.	typ.	max.	Units
MOSFET					
$V_{(BR)DSS}$	$V_{GS} = 0\text{ V}; I_D = 5,6\text{ mA}$	100			V
$V_{GS(th)}$	$V_{GS} = V_{DS}; I_D = 5,6\text{ mA}$	2,5	3,3		V
I_{DSS}	$V_{GS} = 0\text{ V}; V_{DS} = V_{DSS}; T_j = 25\text{ }^\circ\text{C}$			100	μA
I_{GSS}	$V_{GS} = \pm 20\text{ V}; V_{DS} = 0\text{ V}$			100	nA
$R_{DS(on)}$	$I_D = 80\text{ A}; V_{GS} = 10\text{ V}; T_j = 25\text{ }^\circ\text{C}$			7,5	m Ω
$R_{DS(on)}$	$I_D = 80\text{ A}; V_{GS} = 10\text{ V}; T_j = 125\text{ }^\circ\text{C}$			13,5	m Ω
C_{CHC}	per MOSFET				pF
C_{iss}	under following conditions:		9,1		nF
C_{oss}	$V_{GS} = 0\text{ V}; V_{DS} = 25\text{ V}; f = 1\text{ MHz}$		1,8		nF
C_{rss}			1,6		nF
L_{DS}					nH
$t_{d(on)}$	under following conditions:		300		ns
t_r	$V_{DD} = 50\text{ V}; V_{GS} = 10\text{ V};$ $I_D = 50\text{ A}$		140		ns
$t_{d(off)}$	$R_G = 56\text{ }\Omega$		1550		ns
t_f			150		ns
$R_{th(j-s)}$	per MOSFET (per module)			1,1	K/W
Inverse diode					
V_{SD}	$I_F = 50\text{ A}; V_{GS} = 0\text{ V}; T_j = \text{ }^\circ\text{C}$		0,9		V
I_{RRM}	under following conditions:		24		A
Q_{rr}	$I_F = 50\text{ A}; T_{vj} = 25\text{ }^\circ\text{C}; R_G = 56\text{ }\Omega$		0,9		μC
t_{rr}	$V_R = 65\text{ A}; di/dt = 100\text{ A}/\mu\text{s}$		70		ns
Free-wheeling diode					
V_F	$I_F = \text{ A}; V_{GS} = \text{ V}$				V
I_{RRM}	under following conditions:				A
Q_{rr}	$I_F = \text{ A}; T_{vj} = \text{ }^\circ\text{C}$				μC
t_{rr}	$V_r = \text{ A}; di/dt = \text{ A}/\mu\text{s}$				ns
Mechanical data					
M1	mounting torque			2	Nm
w			20		g
Case					

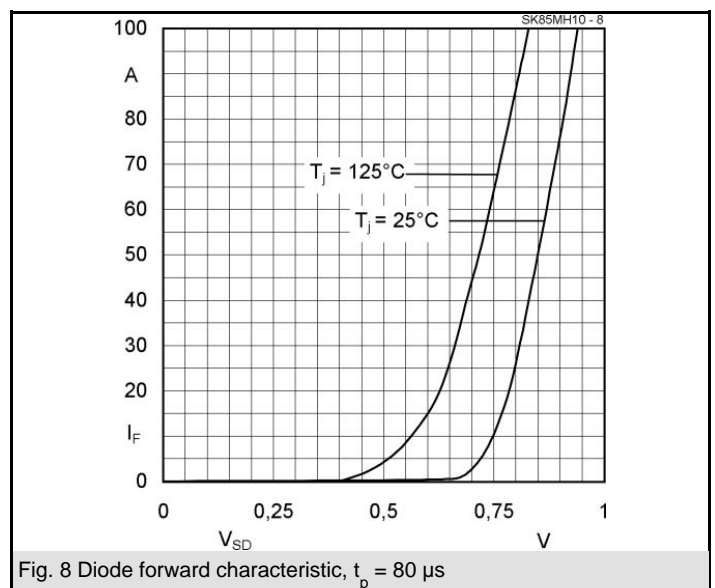
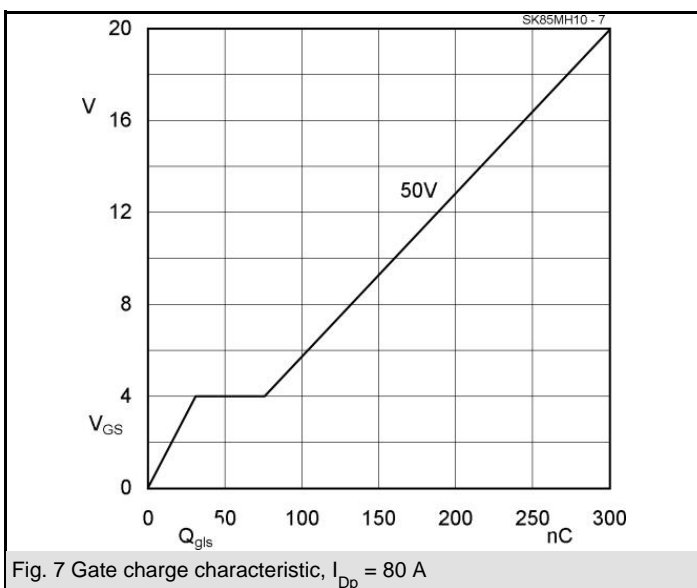
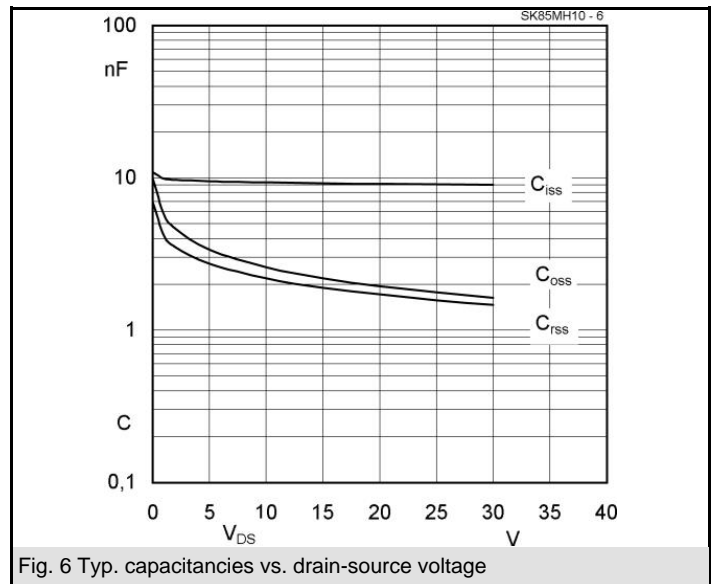
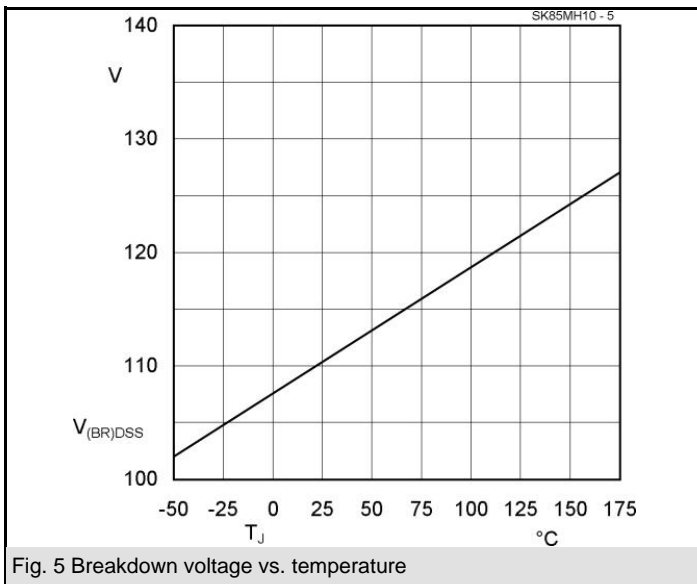
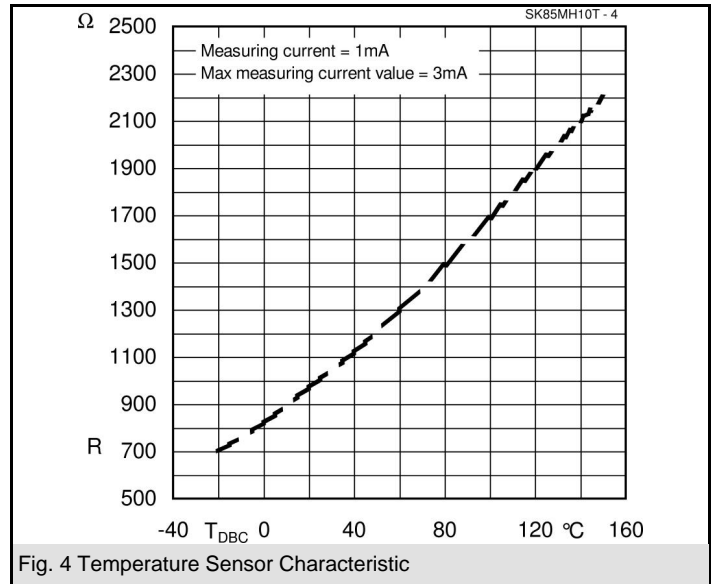
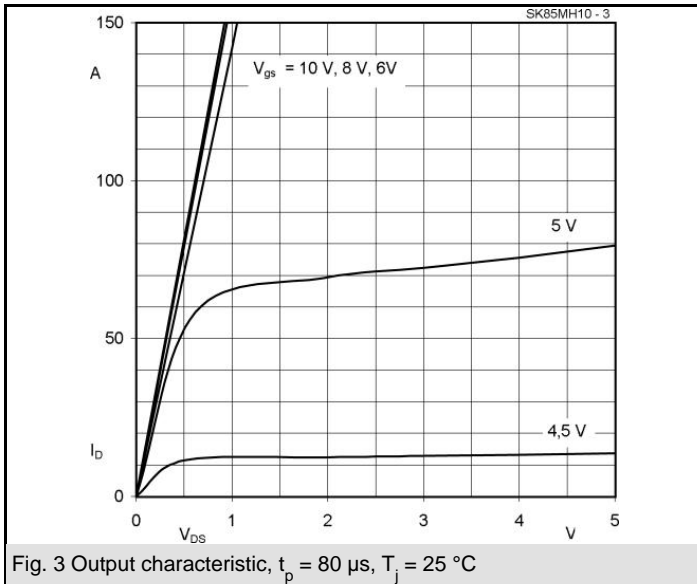

SK 85 MH 10 T

Dimensions in mm

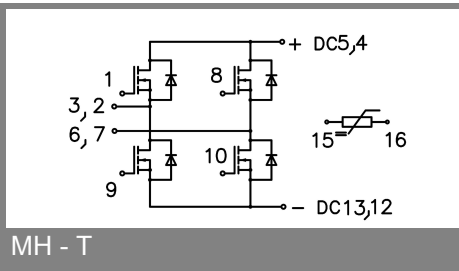
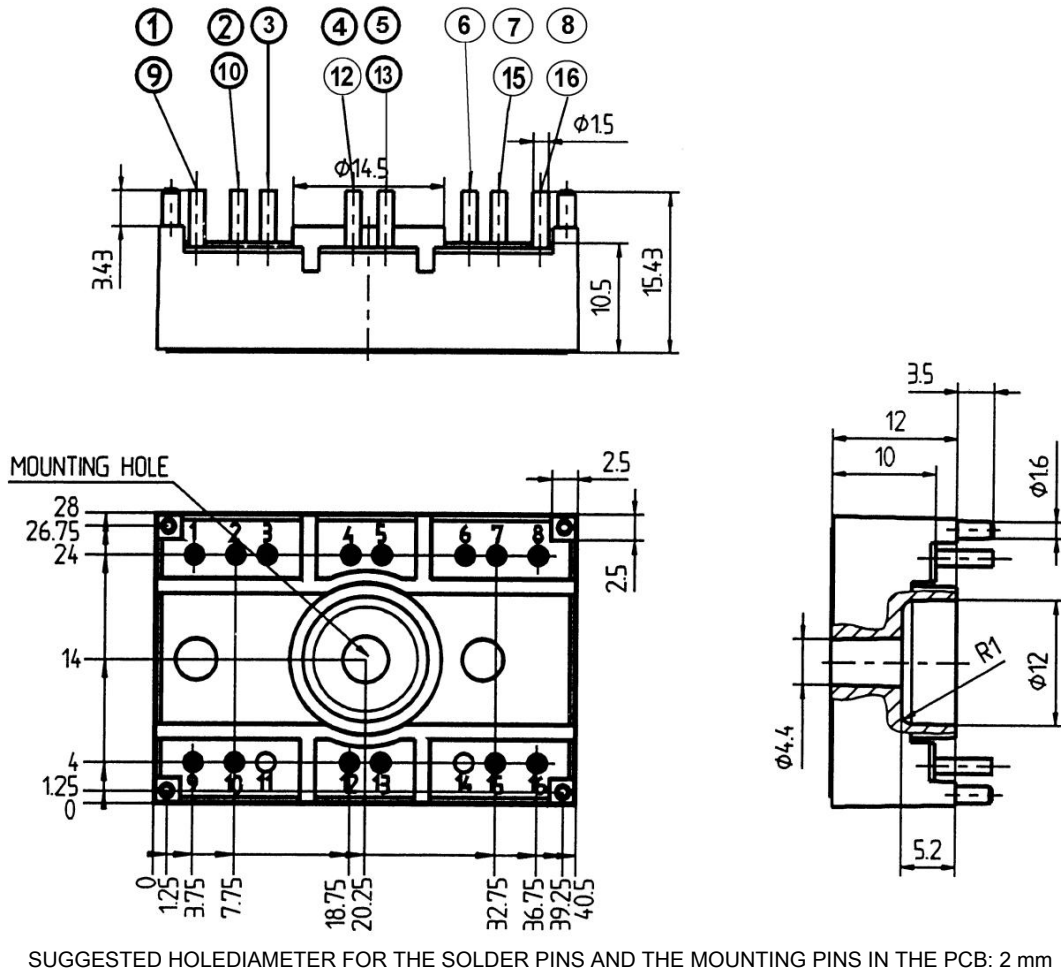

This is an electrostatic discharge sensitive device (ESDS), international standard IEC 60747-1, Chapter IX.

* The specifications of our components may not be considered as an assurance of component characteristics. Components have to be tested for the respective application. Adjustments may be necessary. The use of SEMIKRON products in life support appliances and systems is subject to prior specification and written approval by SEMIKRON. We therefore strongly recommend prior consultation of our personal.