

V _{DRM} V _{RSM} V _{RRM} V	I _D (T _{case} = ... °C, full conduction)				
	40 A (92 °C)	40 A (92 °C)	100 A (84 °C)	60 A (86 °C)	100 A (84 °C)
400	SKCH 40/04	SKBT –	SKDH –	SKDT 60/04	SKDT –
800	40/08	40/08	100/08	60/08	100/08
1200	40/12	40/12	100/12	60/12	100/12
1400	40/14	40/14	100/14	60/14	100/14
1600	40/16	–	–	–	–

SEMIPONT® 2
Controllable Bridge
Rectifiers

SKCH 40
SKBT 40
SKDH 100

SKDT 60
SKDT 100



Symbol	Conditions	SKCH 40 SKBT 40	SKDT 60	SKDH 100 SKDT 100	Units
I _D	T _{case} = 85 °C; inductive load	46	61	98	A
	T _{amb} = 45 °C, chassis ¹⁾	15	16	20	A
	P13A/125	18	21	25	A
	R4A/120	18			A
	P1A/120	28	34	45	A
	T _{amb} = 35 °C, P1A/120 F	47	57	85	A
	P3/180 F	55	65	95	A
I _{TSM}	T _{vj} = 25 °C, 10 ms	470	470	1000	A
	T _{vj} = 125 °C, 10 ms	400	400	850	A
i ² t	T _{vj} = 25 °C, 8,3...10 ms	1100	1100	5000	A ² s
	T _{vj} = 125 °C, 8,3...10 ms	800	800	3600	A ² s
(di/dt) _{cr}	T _{vj} = 125 °C, 50 Hz	50			A/μs
(dv/dt) _{cr}	T _{vj} = 125 °C, 2/3 V _{DRM}	500			V/μs
I _H	T _{vj} = 25 °C, typ./max.	100/200			mA
I _L	T _{vj} = 25 °C, typ./max.	250/400			mA
V _T	T _{vj} = 25 °C; (I _T = ...)	2,3 (75)	2,3 (75)	1,95 (200)	V A
V _{T(TO)}	T _{vj} = 125 °C	1,0	1,0	1,0	V
r _T	T _{vj} = 125 °C	16	16	4,5	mΩ
I _{DD} ; I _{RD}	T _{vj} = 125 °C; V _{DD} = V _{DRM} V _{RD} = V _{RRM}	10	10	15	mA
V _{GT}	T _{vj} = 25 °C, V _D = 6 V	3			V
I _{GT}	T _{vj} = 25 °C, V _D = 6 V	150			mA
V _{GD}	T _{vj} = 125 °C, V _D = 6 V	0,25			V
R _{thjc}	per thyristor/diode	1,0	1,0	0,85	°C/W
	total	0,25	0,167	0,141	°C/W
R _{thch}	total	0,05			°C/W
T _{vj} , T _{stg}		– 40...+ 125			°C
V _{isol}	a.c.50...60Hz;r.m.s.;1s/1min	3600 / 3000			V~
M ₁	to heatsink } SI (US) units to terminals }	5 (44 lb.in.) ± 15 %			Nm
M ₂		3 (26 lb.in.) ± 15 %			Nm
w		165			g
Case		G 19 G 20	G 21	G 53 G 21	

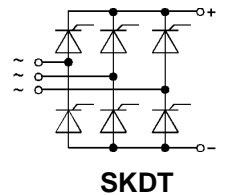
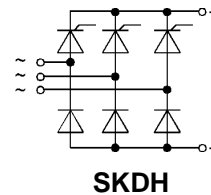
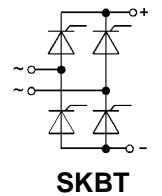
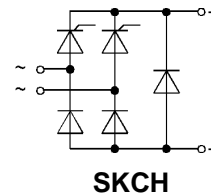

Features

- Fully controlled single and three phase bridge rectifiers
- Robust plastic case with screw terminals
- Large, isolated base plate
- Blocking voltage to 1600 V
- High surge currents
- Easy chassis mounting
- UL recognized, file no. E 63 532

Typical Applications

- SKCH, SKDH, SKDT for DC drives with a fixed direction of rotation
- SKBT, SKDT for reversing DC drives
- Controlled field rectifiers for DC motors
- Controlled battery charger rectifiers

¹⁾ Painted metal sheet of minimum 250 x 250 x 1 mm: R_{thca} = 1,8 °C/W

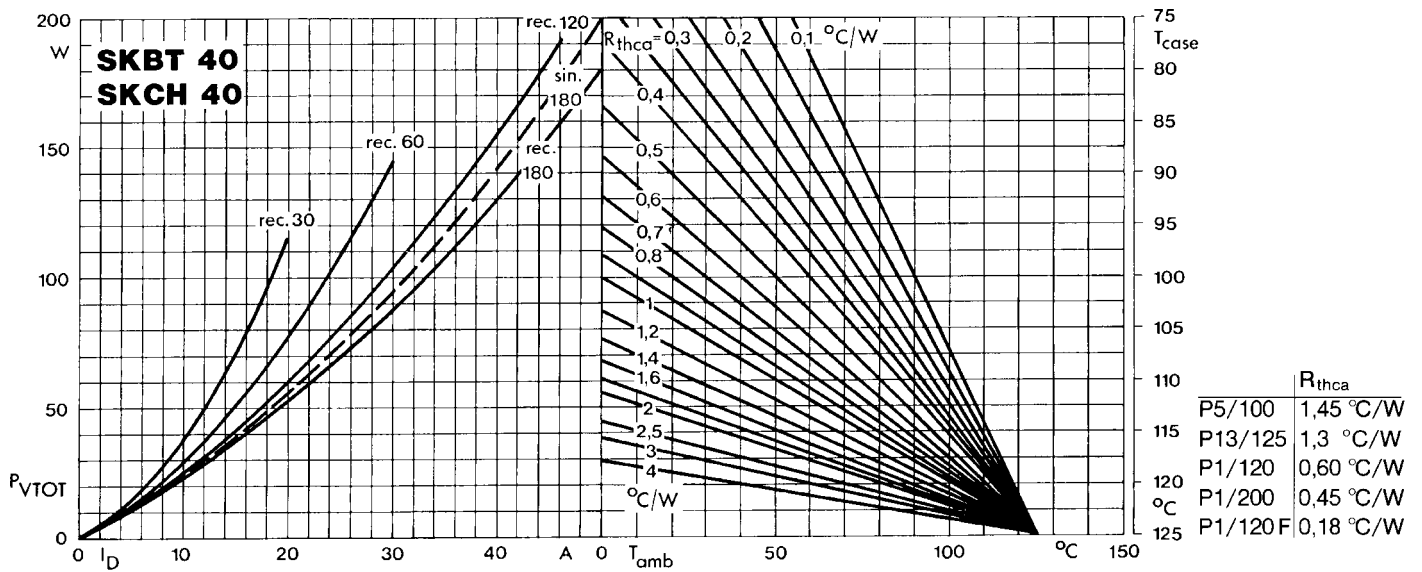

Fig. 4 a Power dissipation vs. output current and case temperature

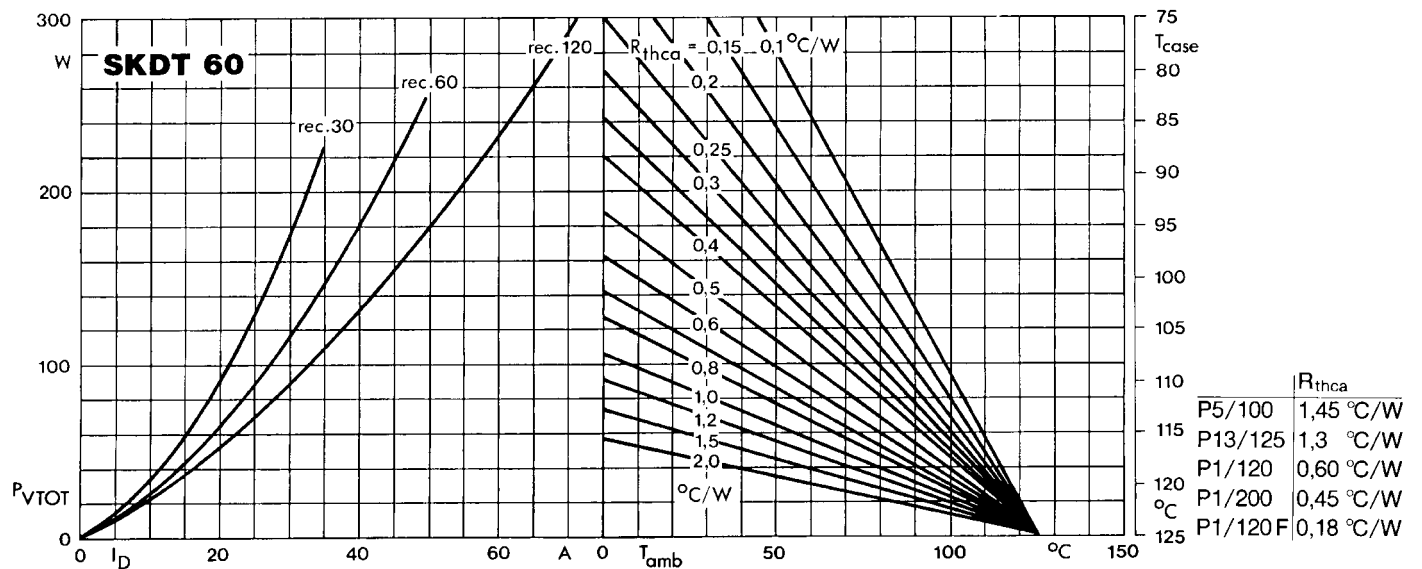

Fig. 4 b Power dissipation vs. output current and case temperature

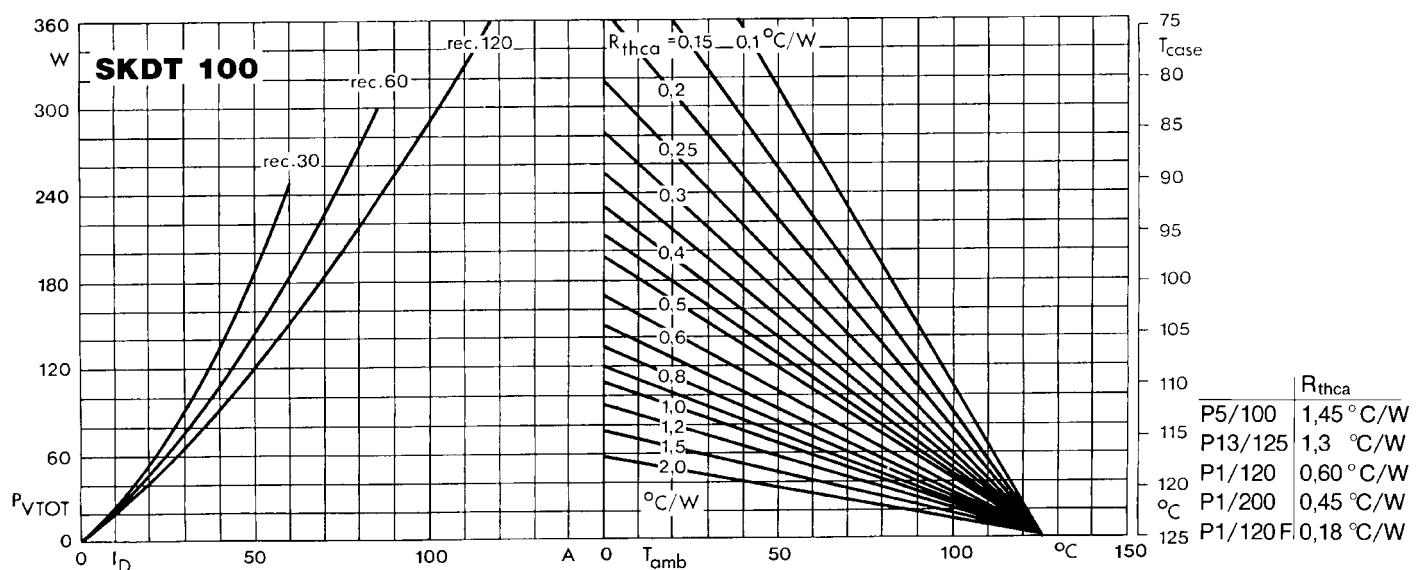

Fig. 4 c Power dissipation vs. output current and case temperature

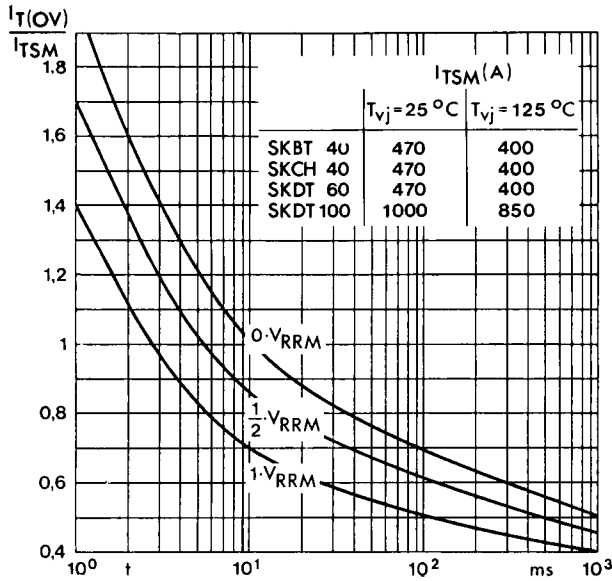

Fig. 5 Surge overload current vs. time

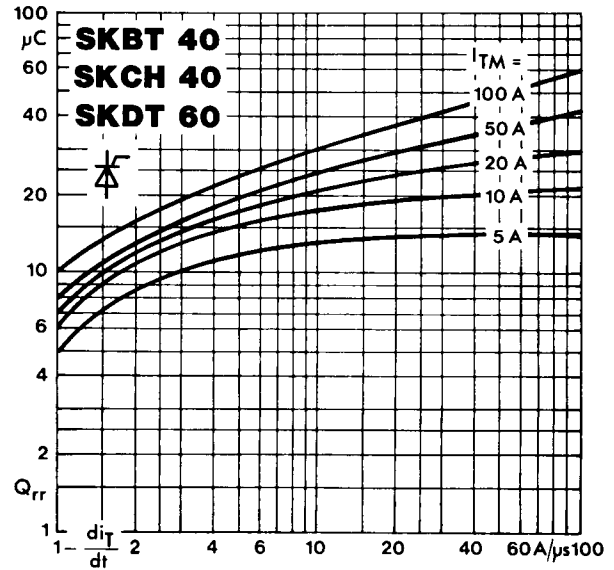

Fig. 8 a Recovered charge vs. current decrease

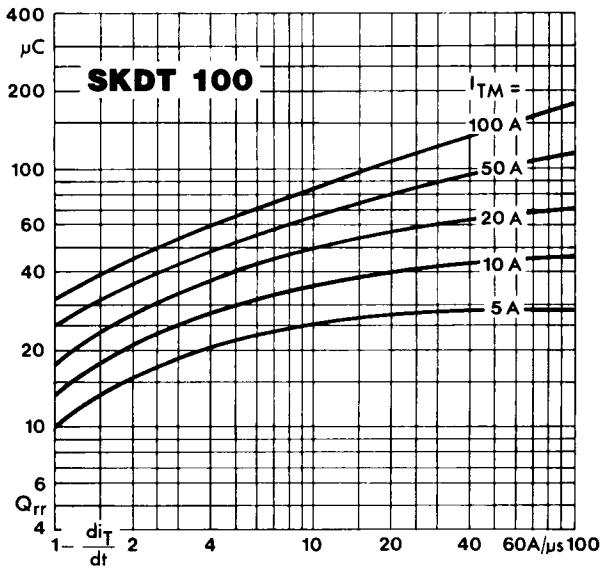

Fig. 8 b. Recovered charge vs. current decrease

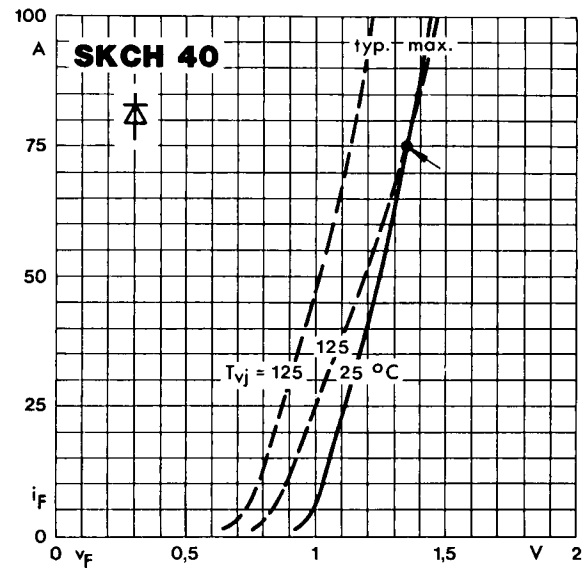

Fig. 9 Forward characteristics of a single diode

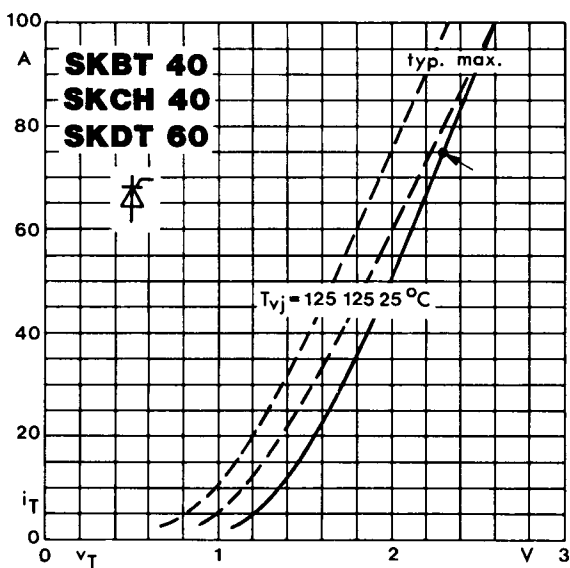

Fig. 10 a On-state characteristics of a single thyristor

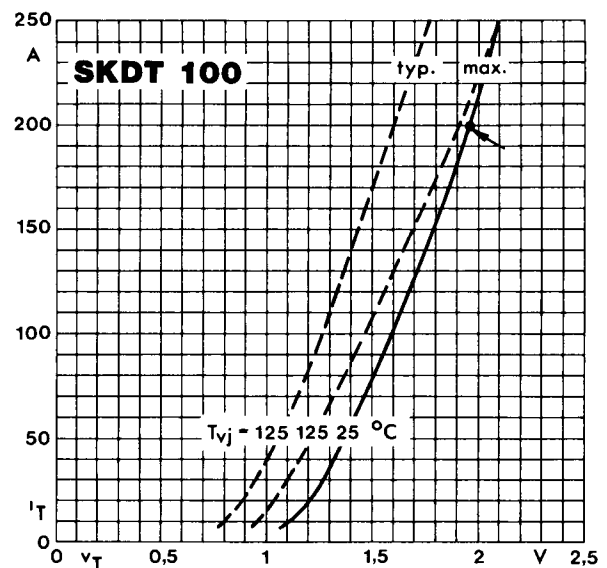

Fig. 10 b On-state characteristics of a single thyristor

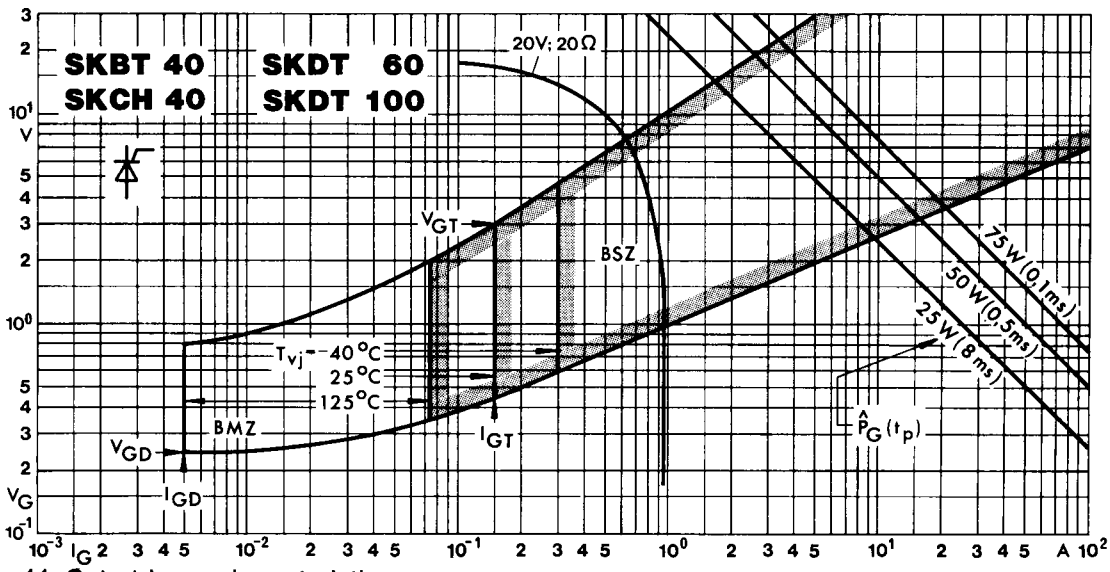

Fig. 11 Gate trigger characteristics

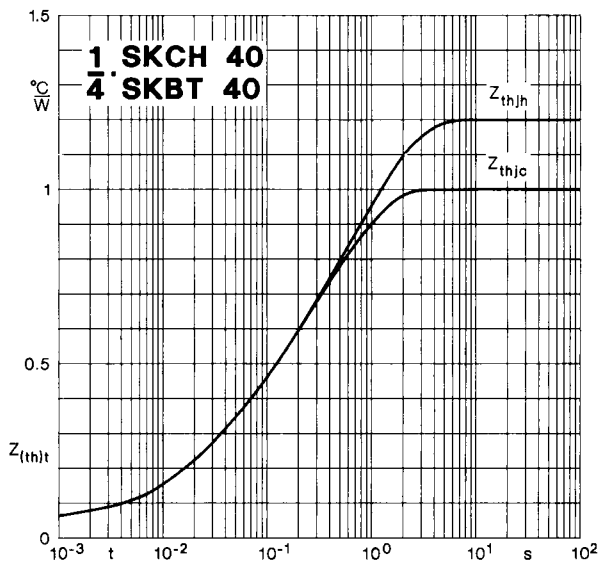

Fig. 12 a Transient thermal impedance vs. time

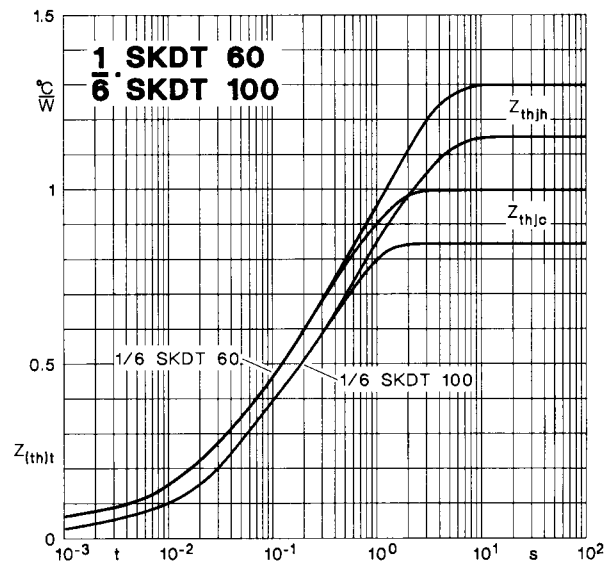
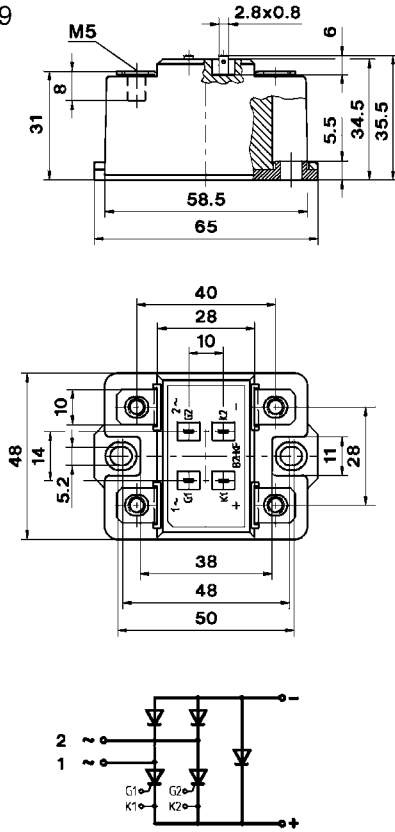

Fig. 12 b Transient thermal impedance vs. time

SKCH 40 SEMIPONT² 2
Case G 19



Dimensions in mm

SKBT 40 SEMIPONT² 2
Case G 20

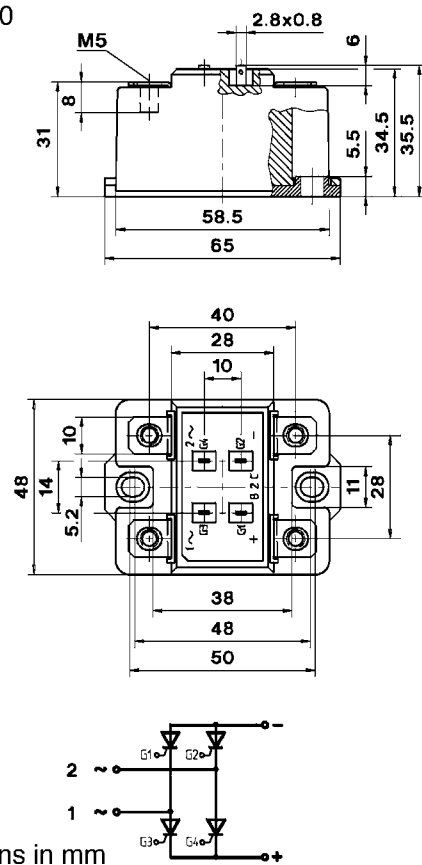

Dimensions in mm

SKDT 60, SKDT 100 SEMIPONT² 2
Case G 21

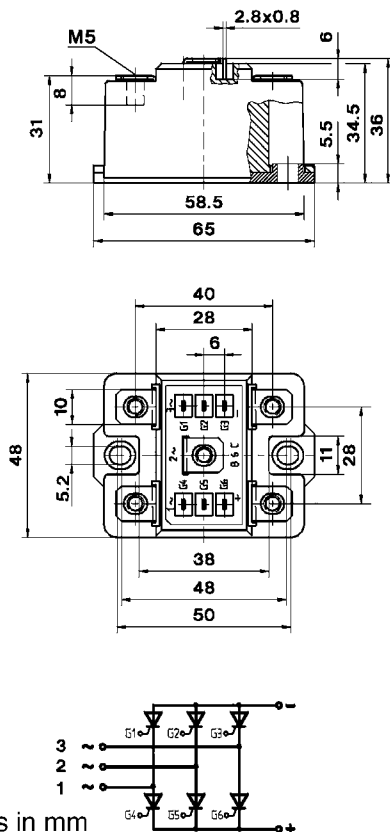

Dimensions in mm

SKDH 100 SEMIPONT² 2
Case G 53

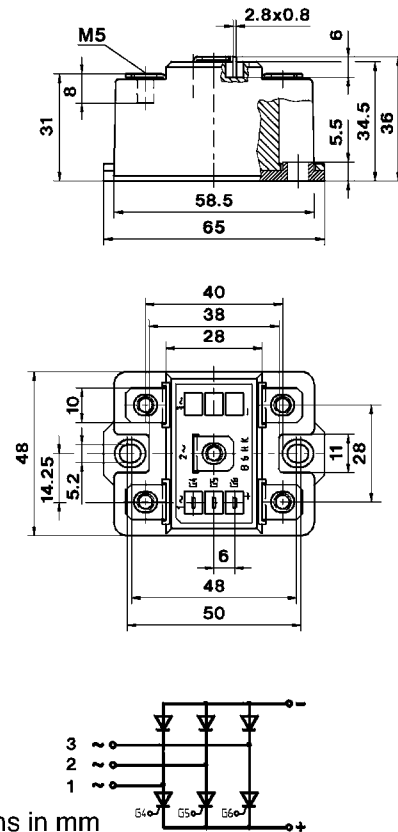

Dimensions in mm

Available Heatsinks

Rectifier	Heatsink	w kg	R _{thca} natural cooling °C/W	R _{thca} forced cooling °C/W
SKB 15	P 5A/100	0,28	1,7	–
SKB 25, SKD 25	P 5A/100	0,28	1,55	–
	R 4A/120	0,6	1,45	–
	P 1/120	1,3	0,75	–
SKBH 28, SKBT 28, SKBZ 28, SKCH 28 SKB 30, SKD 30, SKD 31	P 5A/100	0,28	1,5	–
	R 4A/120	0,6	1,4	–
	P 1/120	1,3	0,7	–
	P13A/125	0,6	1,35	–
SKB 33, SKB 50, SKD 50	P1/120	1,3	0,65	0,30
SKBT 40, SKCH 40 SKB 60, SKD 60, SKDT 60 SKB 52, SKD 62, SKB 72 SKD 82, SKD 100, SKDT 100 SKD 110, SKD 160	P 5A/100	0,28	1,45	–
	R 4A/120	0,6	1,35	–
	P 13A/125	0,6	1,30	–
	P 15/180	1,7	0,8	0,30
	P 1/120	1,3	0,65	0,20
	P 3/180	3,1	0,5	0,18
	P 1/200	2,2	0,52	0,18