

# SKiiP 03NAC12T4V1

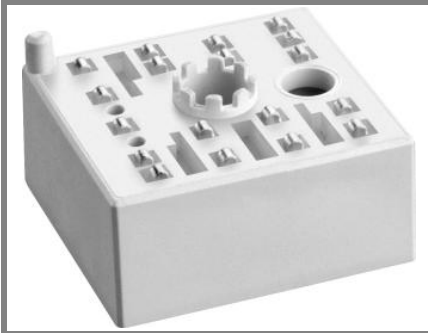

MiniSKiiP<sup>®</sup>0

3-phase bridge rectifier +  
3-phase bridge inverter

SKiiP 03NAC12T4V1

## Features

- Trench 4 IGBTs
- Robust and soft freewheeling diodes in CAL technology
- Highly reliable spring contacts for electrical connections
- UL recognised file no. E 63532

## Remarks

- $V_{CEsat}$ ,  $V_F$  = chip level value
- Case temp. limited to  $T_C = 125^\circ\text{C}$  max. (for baseplateless modules  $T_C = T_S$ )
- product rel. results valid for  $T_{j \leq 150}$  (recomm.  $T_{op} = -40 \dots +150^\circ\text{C}$ )
- Temp.Sensor: No basic insulaton to main circuit, max. potential difference 850V to -DC

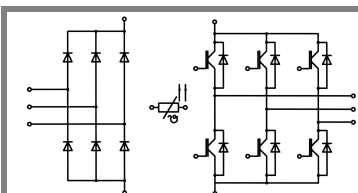

NAC

Absolute Maximum Ratings		$T_S = 25^\circ\text{C}$ , unless otherwise specified		
Symbol	Conditions	Values	Units	
<b>IGBT - Inverter</b>				
$V_{CES}$	$T_s = 25 (70)^\circ\text{C}$	1200	V	
$I_C$		7,5 (7,5)	A	
$I_{CRM}$		24	A	
$V_{GES}$		$\pm 20$	V	
$T_j$		-40...+175	$^\circ\text{C}$	
<b>Diode - Inverter</b>				
$I_F$	$T_s = 25 (70)^\circ\text{C}$	9 (9)	A	
$I_{FRM}$		24	A	
$T_j$		-40...+175	$^\circ\text{C}$	
<b>Diode - Rectifier</b>				
$V_{RRM}$	$T_s = 70^\circ\text{C}$	1600	V	
$I_F$		35	A	
$I_{FSM}$		$t_p = 10 \text{ ms, sin } 180^\circ, T_j = 25^\circ\text{C}$	220	A
$i^2t$		$t_p = 10 \text{ ms, sin } 180^\circ, T_j = 25^\circ\text{C}$	240	$\text{A}^2\text{s}$
$T_j$		-40...+150	$^\circ\text{C}$	
<b>Module</b>				
$I_{tRMS}$	per power terminal (20 A / spring)	20	A	
$T_{stg}$		-40...+125	$^\circ\text{C}$	
$V_{isol}$	AC, 1 min.	2500	V	

Characteristics		$T_S = 25^\circ\text{C}$ , unless otherwise specified			
Symbol	Conditions	min.	typ.	max.	Units
<b>IGBT - Inverter</b>					
$V_{CEsat}$	$I_{Cnom} = 8 \text{ A}, T_j = 25 (150)^\circ\text{C}$		1,85 (2,25)	2,1 (2,5)	V
$V_{GE(th)}$	$V_{GE} = V_{CE}, I_C = 1 \text{ mA}$	5	5,8	6,5	V
$V_{CE(TO)}$	$T_j = 25 (150)^\circ\text{C}$		0,8 (0,7)	0,9 (0,8)	V
$r_T$	$T_j = 25 (150)^\circ\text{C}$		131 (194)	150 (213)	$\text{m}\Omega$
$C_{ies}$	$V_{CE} = 25 \text{ V}, V_{GE} = 0 \text{ V}, f = 1 \text{ MHz}$		0,49		nF
$C_{oes}$	$V_{CE} = 25 \text{ V}, V_{GE} = 0 \text{ V}, f = 1 \text{ MHz}$		0,05		nF
$C_{res}$	$V_{CE} = 25 \text{ V}, V_{GE} = 0 \text{ V}, f = 1 \text{ MHz}$		0,03		nF
$R_{th(j-s)}$	per IGBT		1,84		K/W
$t_{d(on)}$	under following conditions		32		ns
$t_r$	$V_{CC} = 600 \text{ V}, V_{GE} = \pm 15 \text{ V}$		34		ns
$t_{d(off)}$	$I_{Cnom} = 8 \text{ A}, T_j = 150^\circ\text{C}$		295		ns
$t_f$	$R_{Gon} = R_{Goff} = 47 \Omega$		68		ns
$E_{on}$	inductive load		0,9		mJ
$E_{off}$			0,7		mJ
<b>Diode - Inverter</b>					
$V_F = V_{EC}$	$I_{Fnom} = 8 \text{ A}, T_j = 25 (150)^\circ\text{C}$		2,4 (2,45)	2,75 (2,8)	V
$V_{(TO)}$	$T_j = 25 (150)^\circ\text{C}$		1,3 (0,9)	1,5 (1,1)	V
$r_T$	$T_j = 25 (150)^\circ\text{C}$		138 (194)	156 (213)	$\text{m}\Omega$
$R_{th(j-s)}$	per diode		2,53		K/W
$I_{RRM}$	under following conditions		7,7		A
$Q_{rr}$	$I_{Fnom} = 8 \text{ A}, V_R = 600 \text{ V}$		1,23		$\mu\text{C}$
$E_{rr}$	$V_{GE} = 0 \text{ V}, T_j = 150^\circ\text{C}$		0,5		mJ
	$di_F/dt = 335 \text{ A}/\mu\text{s}$				
<b>Diode - Rectifier</b>					
$V_F$	$I_{Fnom} = 15 \text{ A}, T_j = 25^\circ\text{C}$		1,1		V
$V_{(TO)}$	$T_j = 150^\circ\text{C}$		0,8		V
$r_T$	$T_j = 150^\circ\text{C}$		20		$\text{m}\Omega$
$R_{th(j-s)}$	per diode		1,5		K/W
<b>Temperature Sensor</b>					
$R_{ts}$	3 %, $T_r = 25 (100)^\circ\text{C}$		1000(1670)		$\Omega$
<b>Mechanical Data</b>					
w			20		g
$M_s$	Mounting torque	2		2,5	Nm

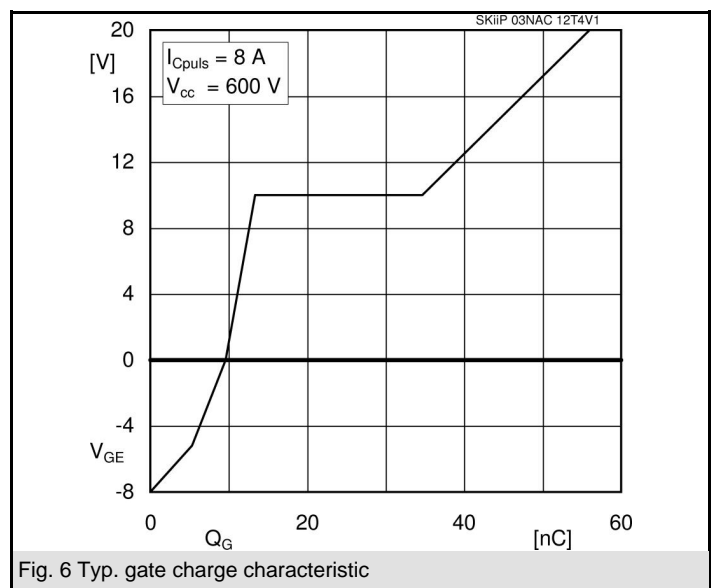
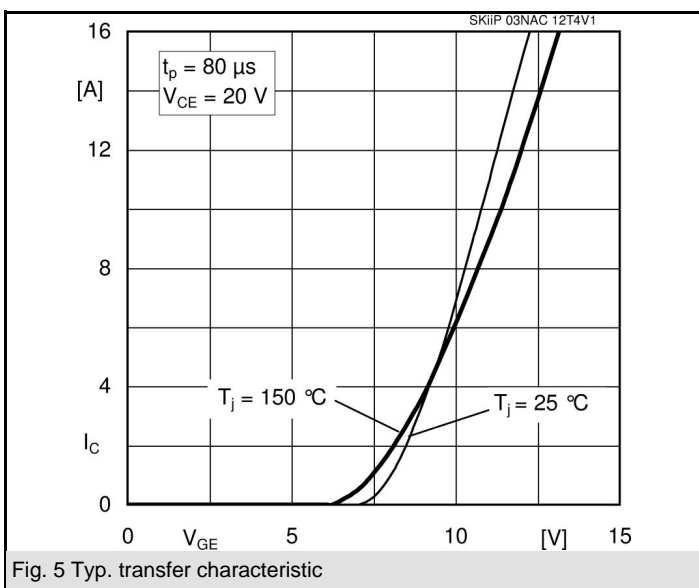
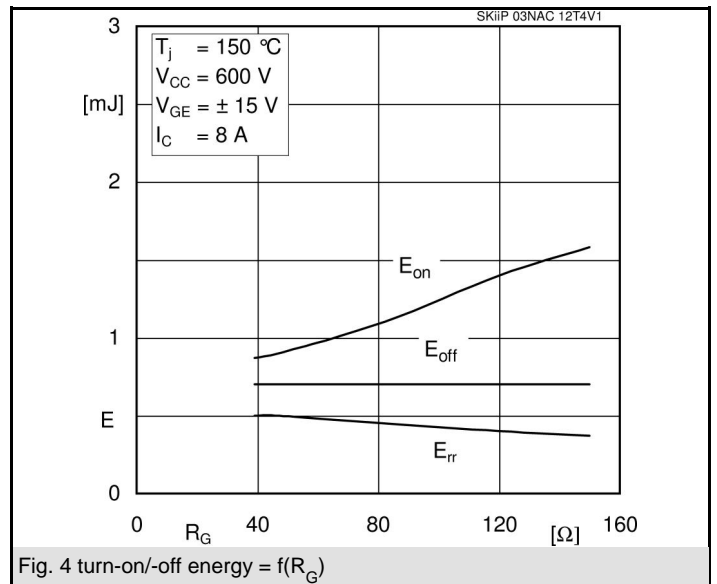
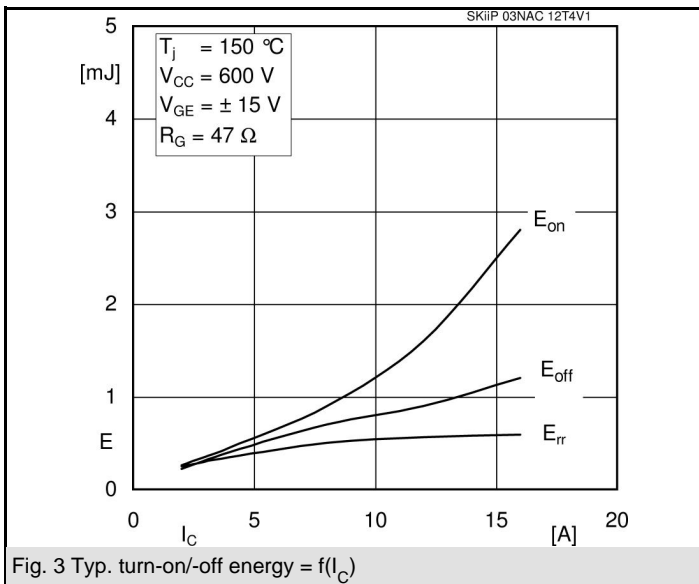
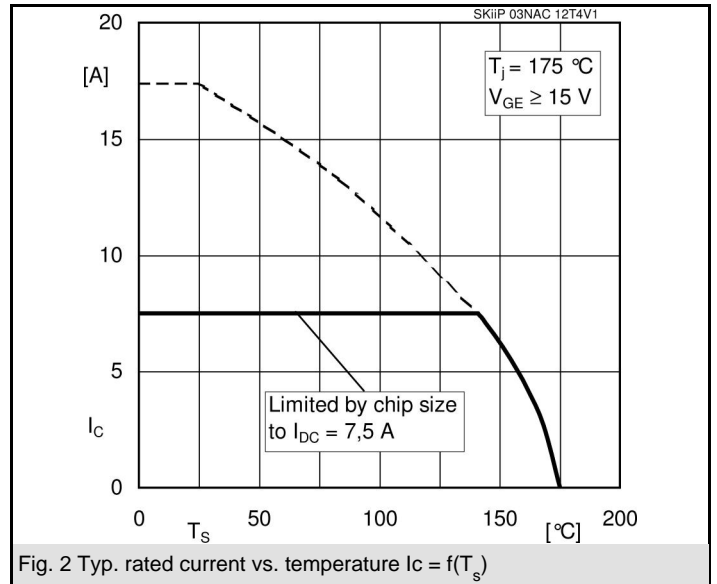
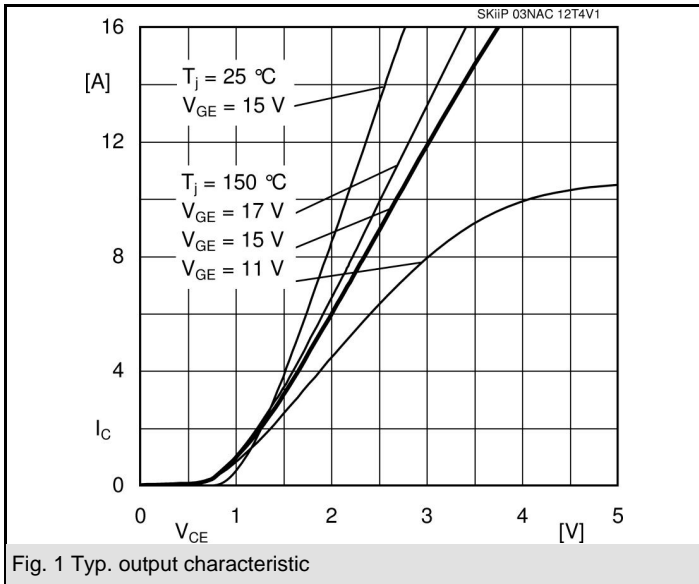

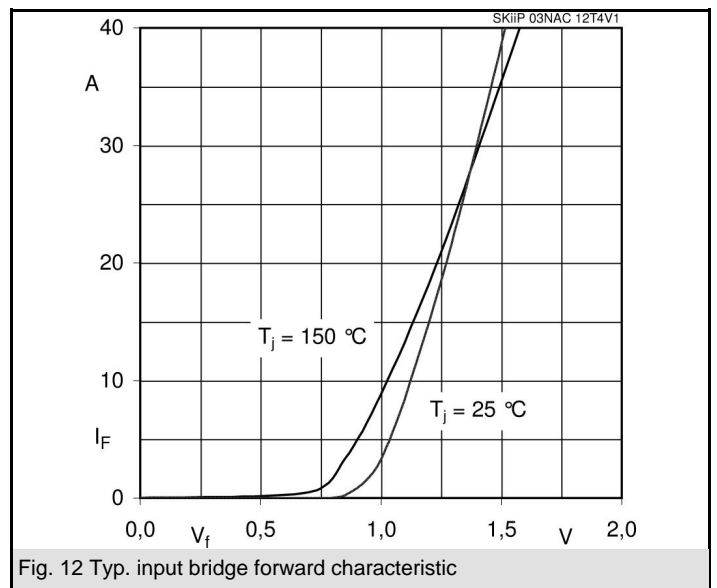
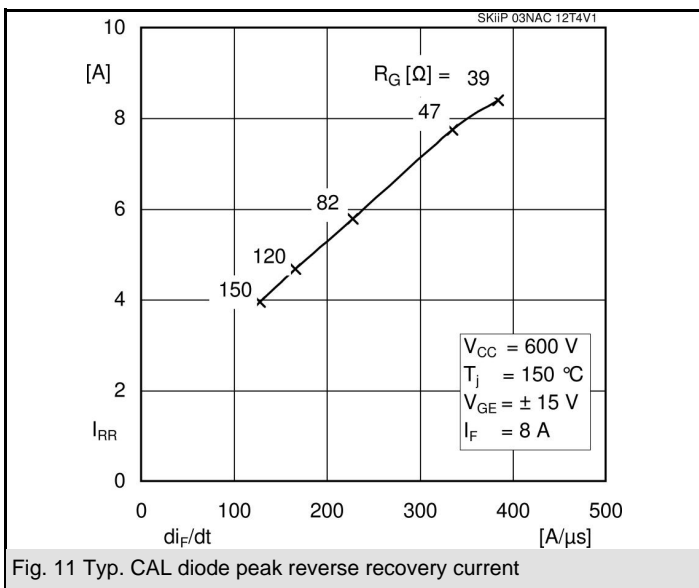
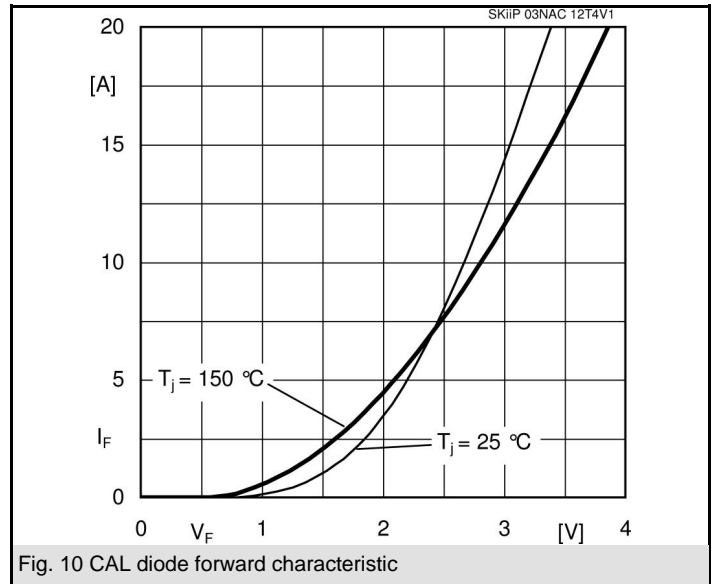
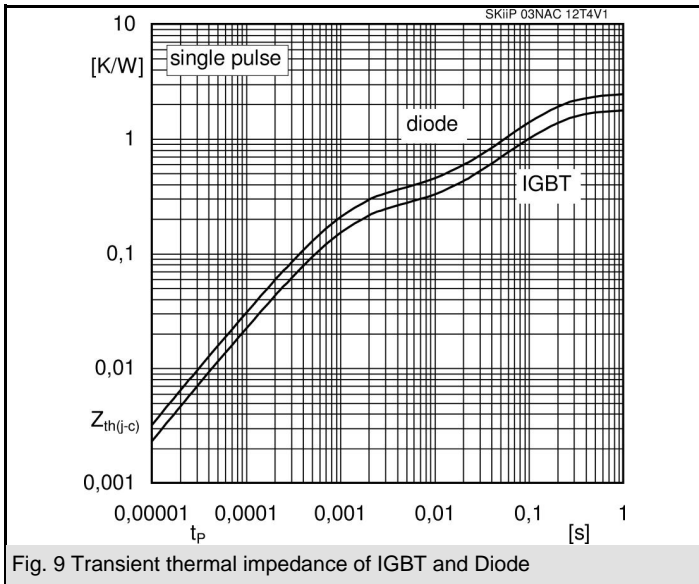
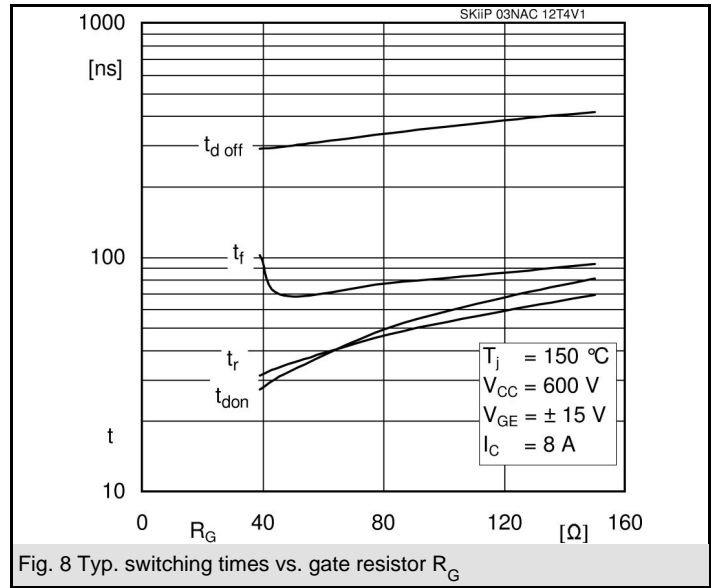
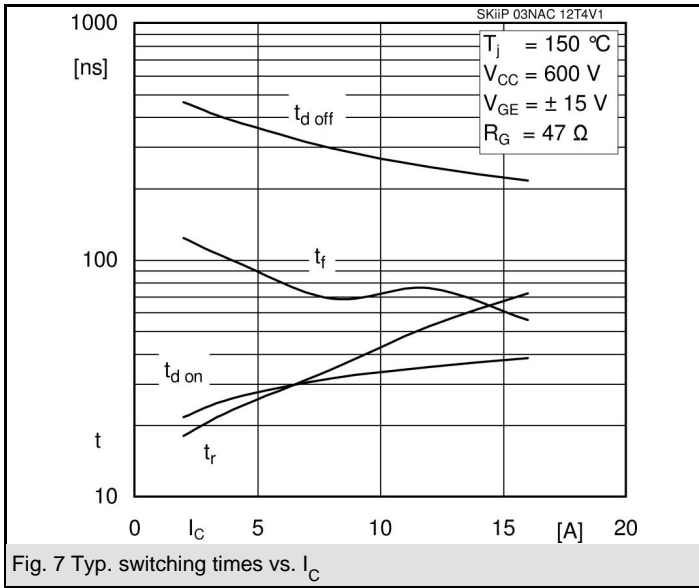

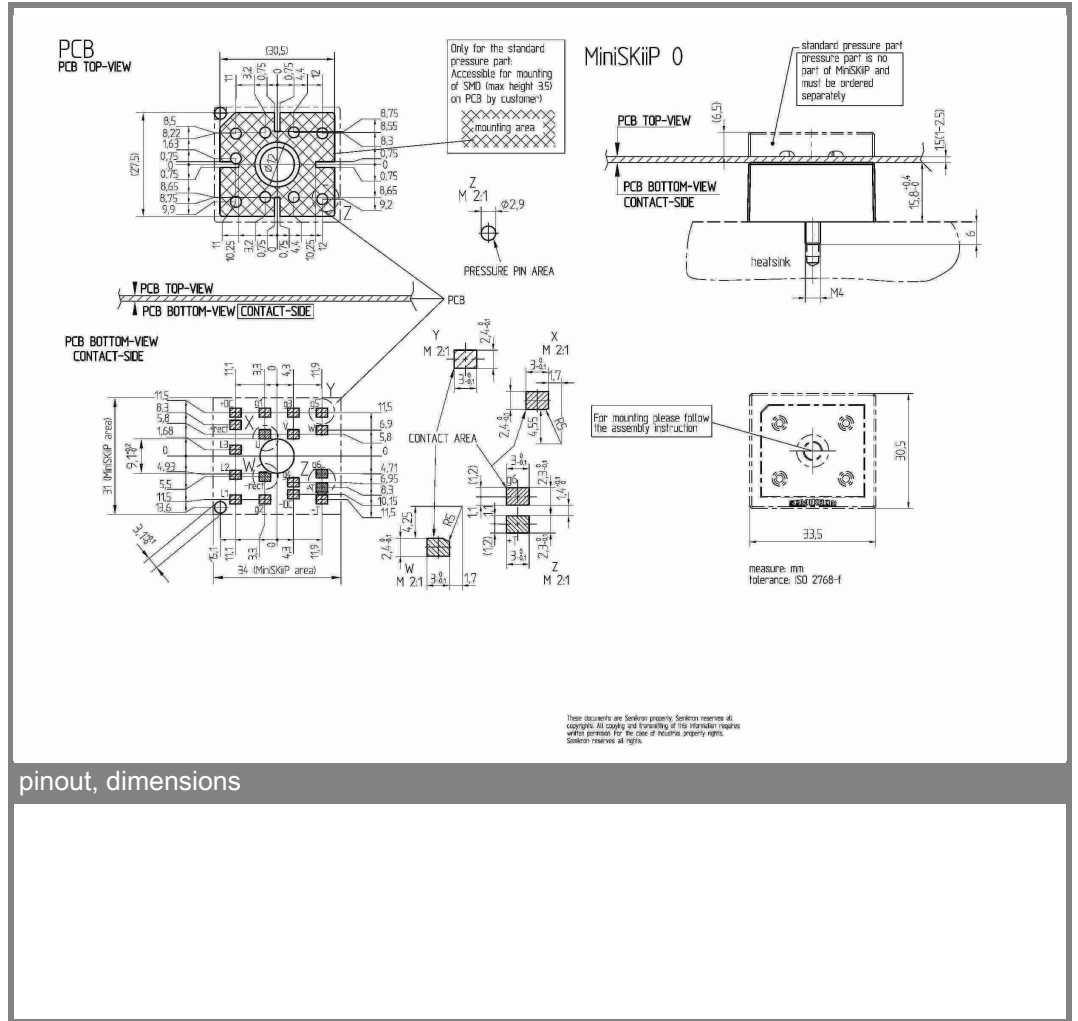
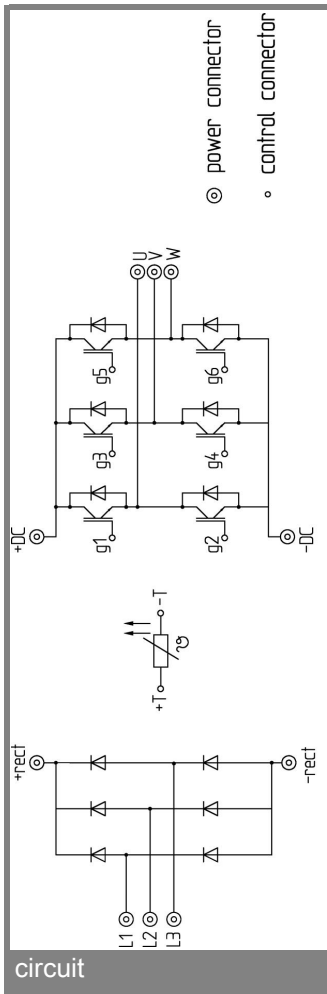

This is an electrostatic discharge sensitive device (ESDS), international standard IEC 60747-1, Chapter IX.

\* The specifications of our components may not be considered as an assurance of component characteristics. Components have to be tested for the respective application. Adjustments may be necessary. The use of SEMIKRON products in life support appliances and systems is subject to prior specification and written approval by SEMIKRON. We therefore strongly recommend prior consultation of our personal.