

# SKKT 20, SKKT 20B



**SEMIPACK® 1**

## Thyristor / Diode Modules

**SKKT 20**  
**SKKT 20B**

### Features

- Heat transfer through aluminium oxide ceramic isolated metal baseplate
- Hard soldered joints for high reliability
- UL recognized, file no. E 63 532

### Typical Applications\*

- DC motor control (e. g. for machine tools)
- AC motor soft starters
- Temperature control (e. g. for ovens, chemical processes)
- Professional light dimming (studios, theaters)

1) See the assembly instructions

$V_{RSM}$ V	$V_{RRM}, V_{DRM}$ V	$I_{TRMS} = 40$ A (maximum value for continuous operation)	
		$I_{TAV} = 20$ A (sin. 180; $T_c = 80$ °C)	
900	800	SKKT 20/08E	SKKT 20B08E
1300	1200	SKKT 20/12E	SKKT 20B12E
1500	1400	SKKT 20/14E	SKKT 20B14E
1700	1600	SKKT 20/16E	SKKT 20B16E

Symbol	Conditions	Values	Units
$I_{TAV}$	sin. 180; $T_c = 85$ (100) °C;	18 (13)	A
$I_D$	P3/180; $T_a = 45$ °C; B2 / B6	31 / 38	A
	P3/180F; $T_a = 35$ °C; B2 / B6	46 / 60	A
$I_{RMS}$	P3/180; $T_a = 45$ °C; W1 / W3	42 / 3 * 30	A
$I_{TSM}$	$T_{vj} = 25$ °C; 10 ms	320	A
	$T_{vj} = 125$ °C; 10 ms	280	A
$i^2t$	$T_{vj} = 25$ °C; 8,3 ... 10 ms	510	A <sup>2</sup> s
	$T_{vj} = 125$ °C; 8,3 ... 10 ms	390	A <sup>2</sup> s
$V_T$	$T_{vj} = 25$ °C; $I_T = 75$ A	max. 2,3	V
$V_{T(TO)}$	$T_{vj} = 125$ °C	max. 1	V
$r_T$	$T_{vj} = 125$ °C	max. 16	mΩ
$I_{DD}, I_{RD}$	$T_{vj} = 125$ °C; $V_{RD} = V_{RRM}, V_{DD} = V_{DRM}$	max. 10	mA
$t_{gd}$	$T_{vj} = 25$ °C; $I_G = 1$ A; $di_G/dt = 1$ A/μs	1	μs
$t_{gr}$	$V_D = 0,67 * V_{DRM}$	1	μs
$(di/dt)_{cr}$	$T_{vj} = 125$ °C	max. 150	A/μs
$(dv/dt)_{cr}$	$T_{vj} = 125$ °C	max. 1000	V/μs
$t_q$	$T_{vj} = 125$ °C	80	μs
$I_H$	$T_{vj} = 25$ °C; typ. / max.	100 / 200	mA
$I_L$	$T_{vj} = 25$ °C; $R_G = 33$ Ω; typ. / max.	250 / 400	mA
$V_{GT}$	$T_{vj} = 25$ °C; d.c.	min. 3	V
$I_{GT}$	$T_{vj} = 25$ °C; d.c.	min. 150	mA
$V_{GD}$	$T_{vj} = 125$ °C; d.c.	max. 0,25	V
$I_{GD}$	$T_{vj} = 125$ °C; d.c.	max. 5	mA
$R_{th(j-c)}$	cont.; per thyristor / per module	1,2 / 0,6	K/W
$R_{th(j-c)}$	sin. 180; per thyristor / per module	1,3 / 0,65	K/W
$R_{th(j-c)}$	rec. 120; per thyristor / per module	1,35 / 0,68	K/W
$R_{th(c-s)}$	per thyristor / per module	0,2 / 0,1	K/W
$T_{vj}$		- 40 ... + 125	°C
$T_{stg}$		- 40 ... + 125	°C
$V_{isol}$	a. c. 50 Hz; r.m.s.; 1 s / 1 min.	3600 / 3000	V~
$M_s$	to heatsink	5 ± 15 % <sup>1)</sup>	Nm
$M_t$	to terminal	3 ± 15 %	Nm
$a$		5 * 9,81	m/s <sup>2</sup>
$m$	approx.	95	g
Case	SKKT	A 46	
	SKKT ...B	A 48	



**SKKT**

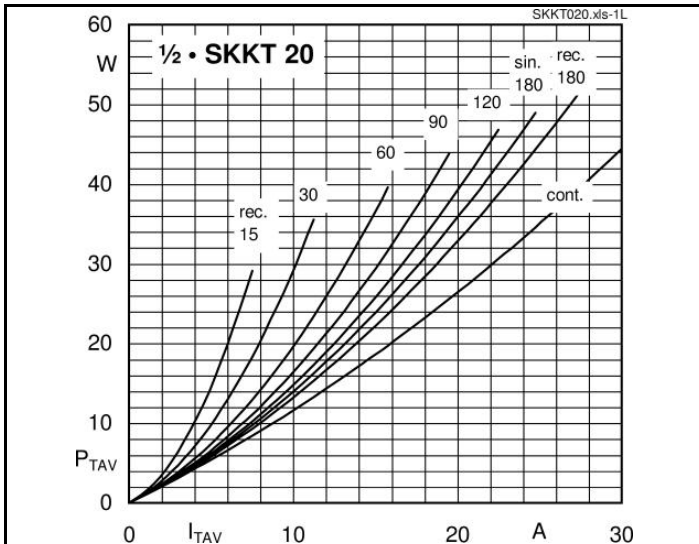

Fig. 1L Power dissipation per thyristor vs. on-state current

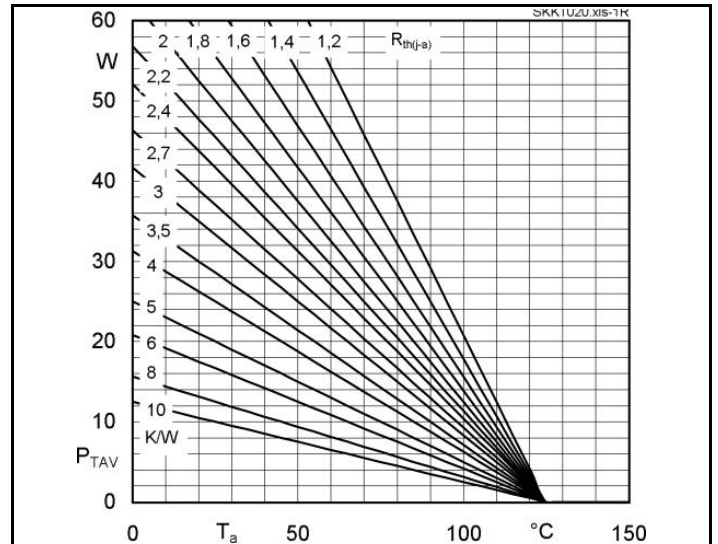

Fig. 1R Power dissipation per thyristor vs. ambient temp.

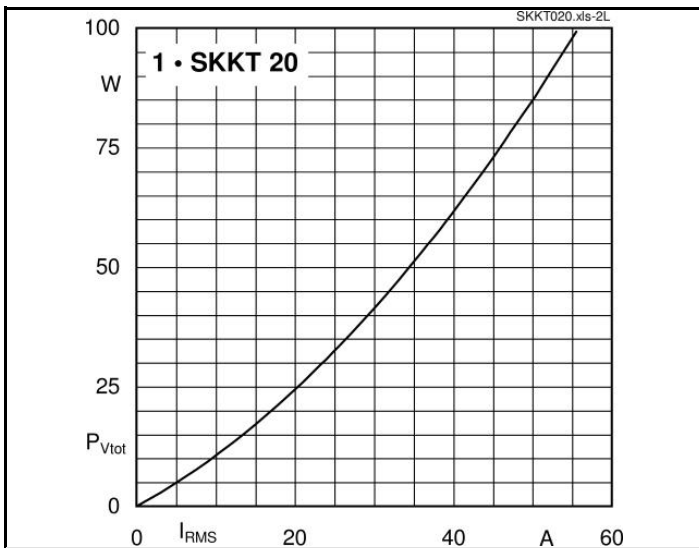

Fig. 2L Power dissipation per module vs. rms current

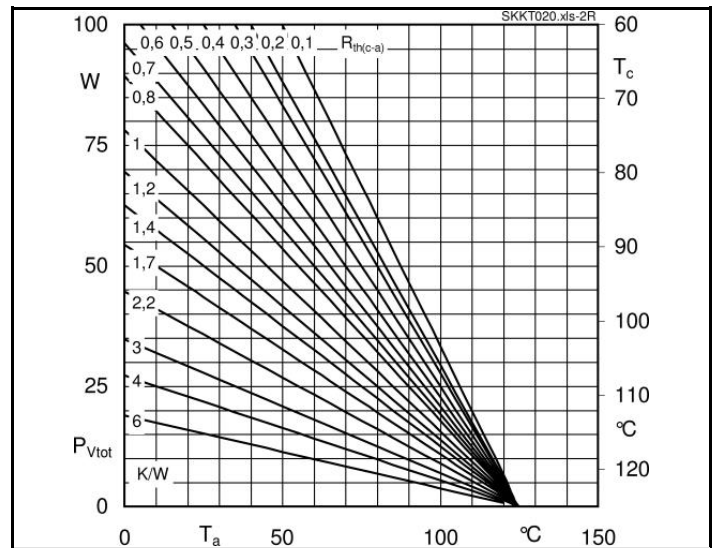

Fig. 2R Power dissipation per module vs. case temp.

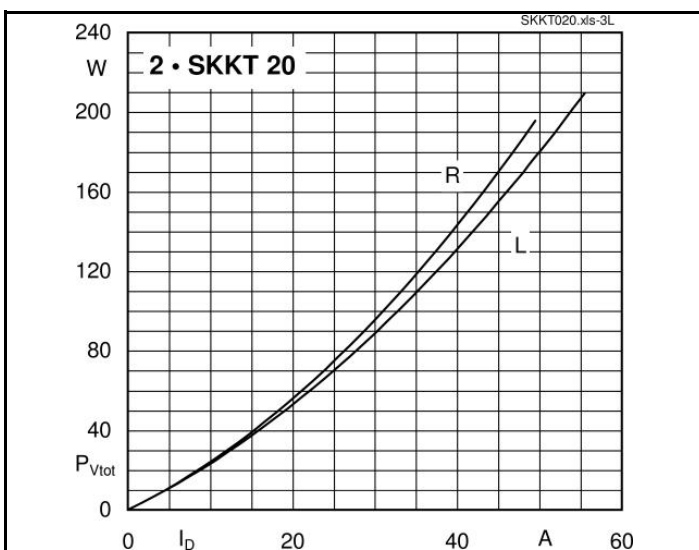

Fig. 3L Power dissipation of two modules vs. direct current

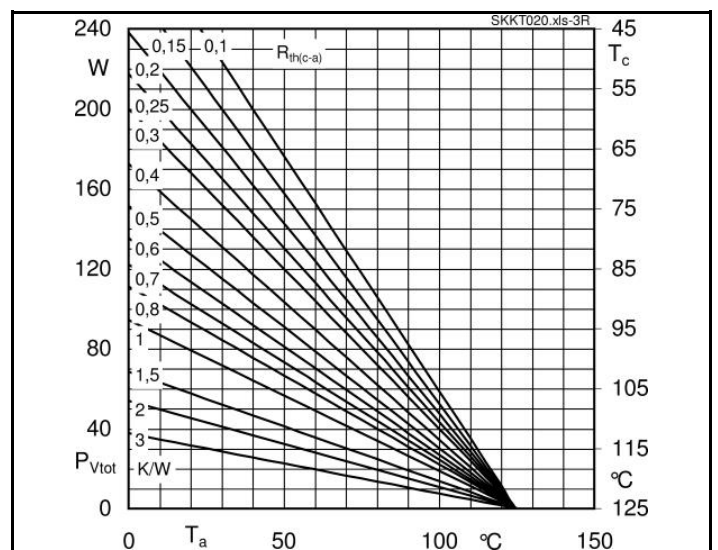
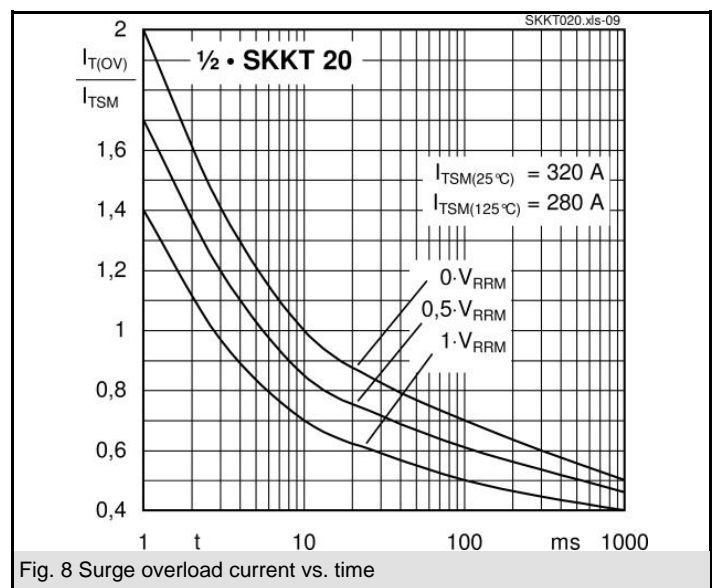
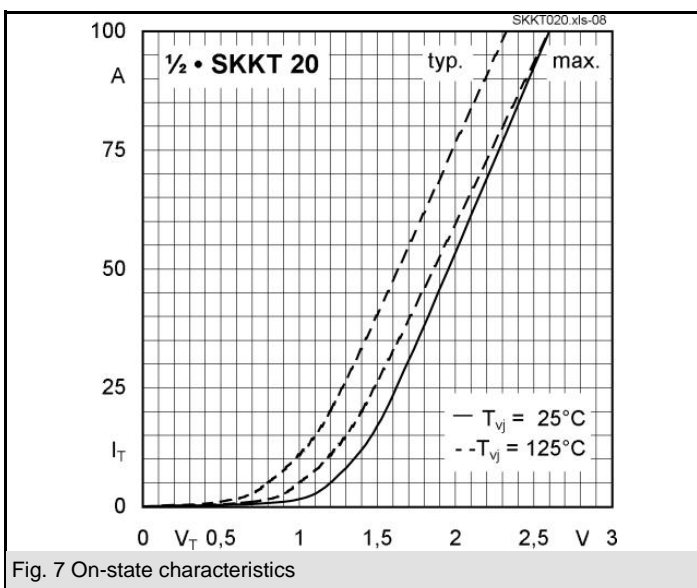
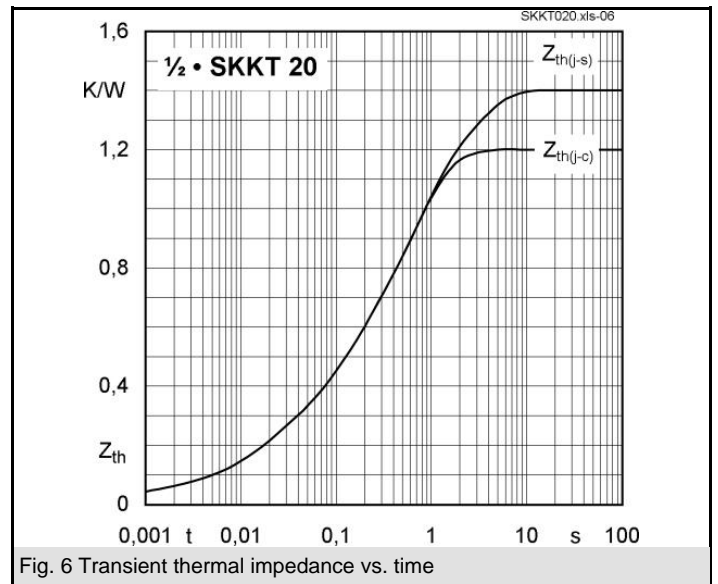
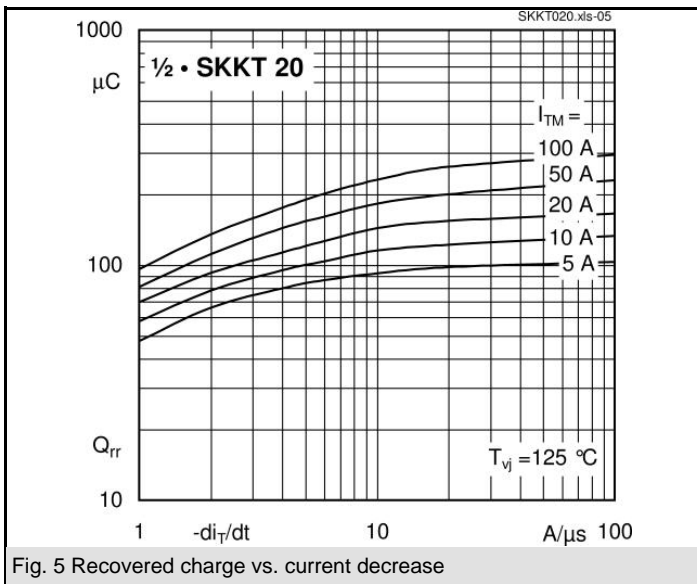
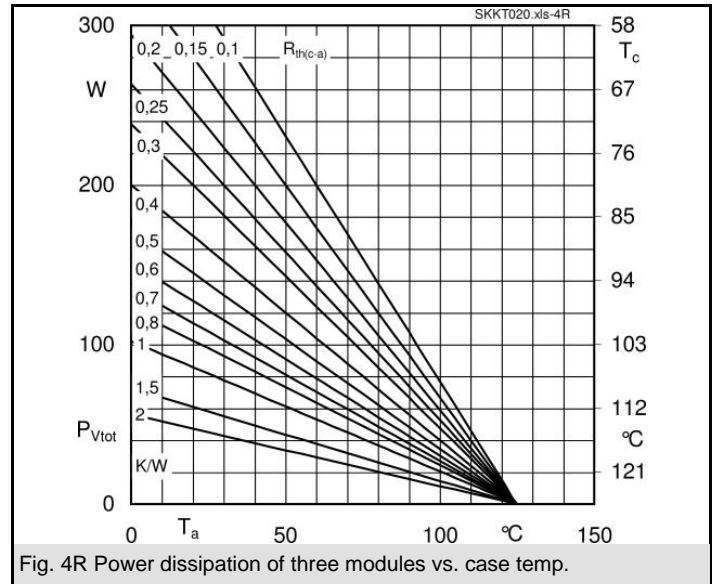
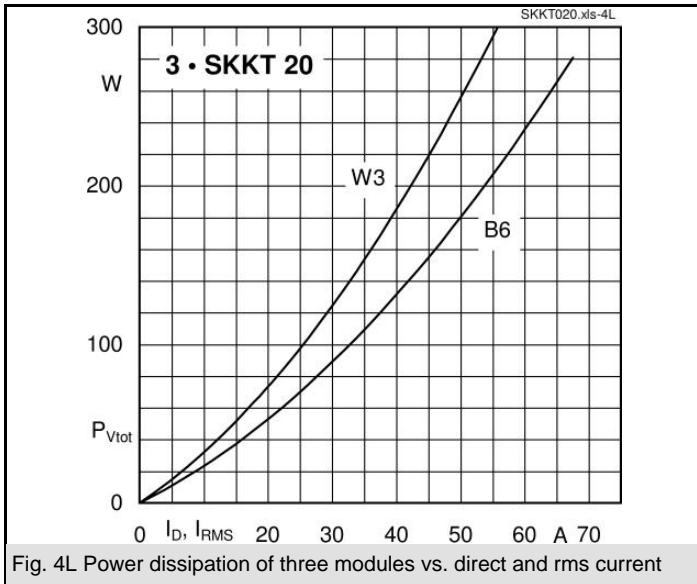

Fig. 3R Power dissipation of two modules vs. case temp.

# SKKT 20, SKKT 20B



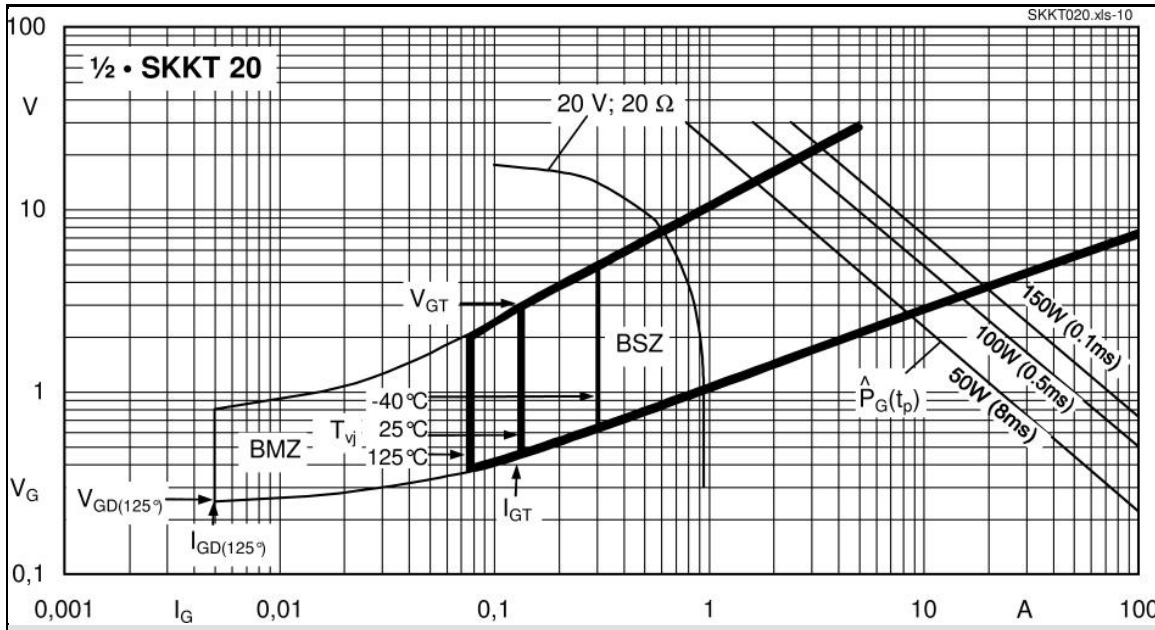
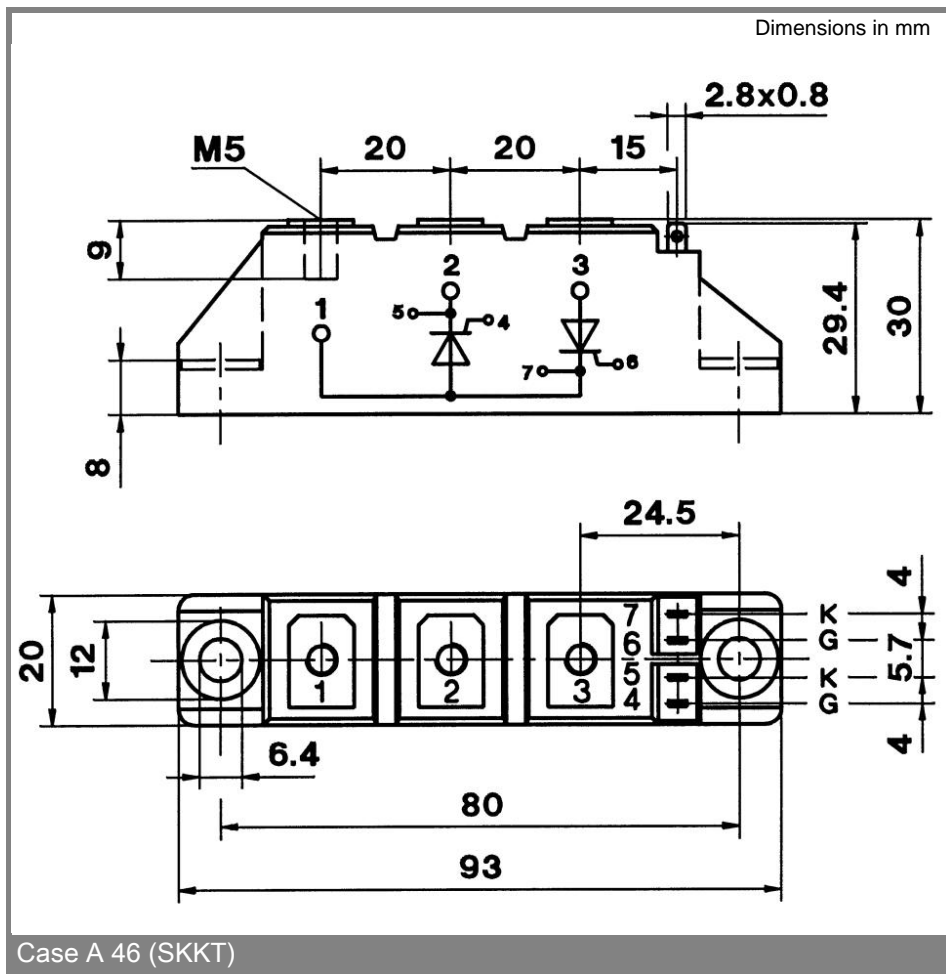
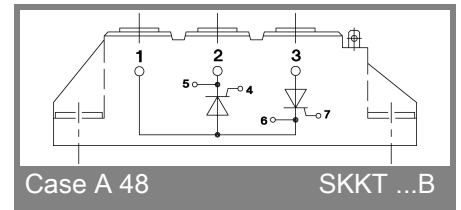

Fig. 9 Gate trigger characteristics



Case A 46 (SKKT)



Case A 48

SKKT ...B

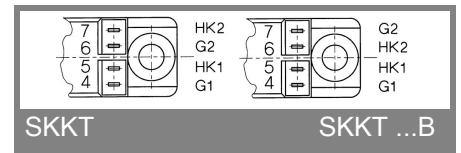

SKKT

SKKT ...B

\* The specifications of our components may not be considered as an assurance of component characteristics. Components have to be tested for the respective application. Adjustments may be necessary. The use of SEMIKRON products in life support appliances and systems is subject to prior specification and written approval by SEMIKRON. We therefore strongly recommend prior consultation of our personal.