

# SKKT 57, SKKH 57, SKKT 57B



## SEMIPACK<sup>®</sup> 1

### Thyristor / Diode Modules

**SKKT 57**  
**SKKH 57**  
**SKKT 57B**

#### Features

- Heat transfer through aluminium oxide ceramic isolated metal baseplate
- Hard soldered joints for high reliability
- UL recognized, file no. E 63 532

#### Typical Applications

- DC motor control (e. g. for machine tools)
- AC motor soft starters
- Temperature control (e. g. for ovens, chemical processes)
- Professional light dimming (studios, theaters)

1) See the assembly instructions

$V_{RSM}$ V	$V_{RRM}, V_{DRM}$ V	$I_{TRMS} = 95 \text{ A}$ (maximum value for continuous operation)		
		$I_{TAV} = 55 \text{ A}$ (sin. 180; $T_c = 80 \text{ }^\circ\text{C}$ )		
900	800	SKKT 57/08E	SKKT 57B08E	SKKH 57/08E
1300	1200	SKKT 57/12E	SKKT 57B12E	SKKH 57/12E
1500	1400	SKKT 57/14E	SKKT 57B14E	SKKH 57/14E
1700	1600	SKKT 57/16E	SKKT 57B16E	SKKH 57/16E
1900	1800	SKKT 57/18E	SKKT 57B18E	SKKH 57/18E
2100	2000	SKKT 57/20EH4		SKKH 57/20EH4
2300	2200	SKKT 57/22EH4		SKKH 57/22EH4

Symbol	Conditions	Values	Units
$I_{TAV}$	sin. 180; $T_c = 85$ (100) $^\circ\text{C}$	55 (35)	A
$I_D$	P3/180; $T_a = 45 \text{ }^\circ\text{C}$ ; B2 / B6	57 / 68	A
	P3/180F; $T_a = 35 \text{ }^\circ\text{C}$ ; B2 / B6	100 / 130	A
$I_{RMS}$	P3/180F; $T_a = 35 \text{ }^\circ\text{C}$ ; W1 / W3	130 / 3 x 100	A
$I_{TSM}$	$T_{vj} = 25 \text{ }^\circ\text{C}$ ; 10 ms	1500	A
	$T_{vj} = 125 \text{ }^\circ\text{C}$ ; 10 ms	1250	A
$i^2t$	$T_{vj} = 25 \text{ }^\circ\text{C}$ ; 8,3 ... 10 ms	11000	A <sup>2</sup> s
	$T_{vj} = 125 \text{ }^\circ\text{C}$ ; 8,3 ... 10 ms	8000	A <sup>2</sup> s
$V_T$	$T_{vj} = 25 \text{ }^\circ\text{C}$ ; $I_T = 1 \text{ A}$	max. 165	V
$V_{T(TO)}$	$T_{vj} = 125 \text{ }^\circ\text{C}$	0,9	V
$r_T$	$T_{vj} = 125 \text{ }^\circ\text{C}$	3,5	m $\Omega$
$I_{DD}; I_{RD}$	$T_{vj} = 25 \text{ }^\circ\text{C}$ ; $V_{RD} = V_{RRM}$ ; $V_{DD} = V_{DRM}$	max. 15	mA
$I_{DD}; I_{RD}$	for SKK .../20E, SKK .../22E	max. 30	mA
$t_{gd}$	$T_{vj} = 25 \text{ }^\circ\text{C}$ ; $I_G = 1 \text{ A}$ ; $di_G/dt = 1 \text{ A}/\mu\text{s}$	1	$\mu\text{s}$
$t_{gr}$	$V_D = 0,67 \cdot V_{DRM}$	2	$\mu\text{s}$
$(di/dt)_{cr}$	$T_{vj} = 125 \text{ }^\circ\text{C}$	max. 150	A/ $\mu\text{s}$
$(dv/dt)_{cr}$	$T_{vj} = 125 \text{ }^\circ\text{C}$	max. 1000	V/ $\mu\text{s}$
$t_q$	$T_{vj} = 125 \text{ }^\circ\text{C}$	80	$\mu\text{s}$
$I_H$	$T_{vj} = 25 \text{ }^\circ\text{C}$ ; typ. / max.	150 / 250	mA
$I_L$	$T_{vj} = 25 \text{ }^\circ\text{C}$ ; $R_G = 33 \text{ }^\circ\Omega$ ; typ. / max.	300 / 600	mA
$V_{GT}$	$T_{vj} = 25 \text{ }^\circ\text{C}$ ; d.c.	min. 3	V
$I_{GT}$	$T_{vj} = 25 \text{ }^\circ\text{C}$ ; d.c.	min. 150	mA
$V_{GD}$	$T_{vj} = 125 \text{ }^\circ\text{C}$ ; d.c.	max. 0,25	V
$I_{GD}$	$T_{vj} = 125 \text{ }^\circ\text{C}$ ; d.c.	max. 6	mA
$R_{th(j-c)}$	cont.; per thyristor / per module	0,57 / 0,29	K/W
$R_{th(j-c)}$	sin. 180; per thyristor / per module	0,6 / 0,3	K/W
$R_{th(j-c)}$	rec. 120; per thyristor / per module	0,64 / 0,32	K/W
$R_{th(c-s)}$	per thyristor / per module	0,2 / 0,1	K/W
$T_{vj}$		- 40 ... + 125	$^\circ\text{C}$
$T_{stg}$		- 40 ... + 125	$^\circ\text{C}$
$V_{isol}$	a. c. 50 Hz; r.m.s.; 1 s / 1 min.	3600 / 3000	V~
$V_{isol}$	a. c. 50 Hz; r.m.s.; 1 s / 1 min. for SKK...H4	4800 / 4000	V~
$M_s$	to heatsink	$5 \pm 15 \%$ <sup>1)</sup>	Nm
$M_t$	to terminals	$3 \pm 15 \%$	Nm
$a$		$5 \cdot 9,81$	m/s <sup>2</sup>
$m$	approx.	95	g
Case	SKKT	A 46	
	SKKT ...B	A 48	
	SKKH	A 47	

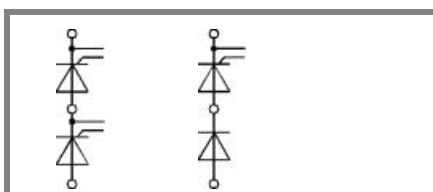

SKKT SKKH

# SKKT 57, SKKH 57, SKKT 57B

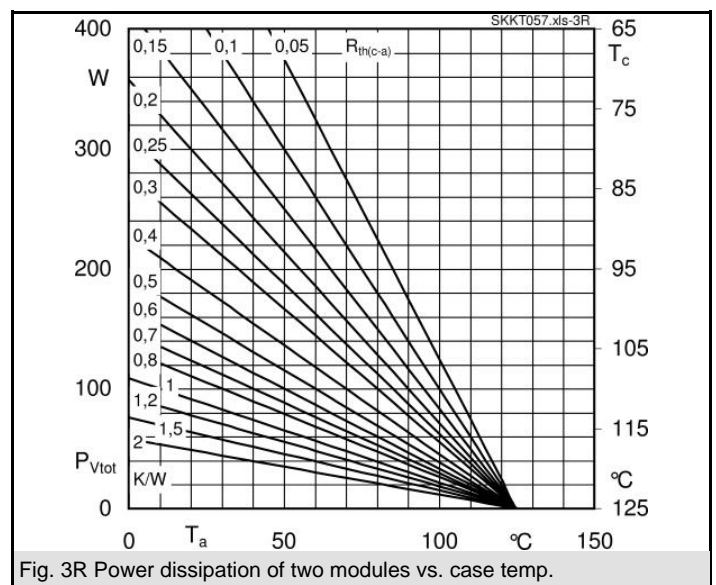
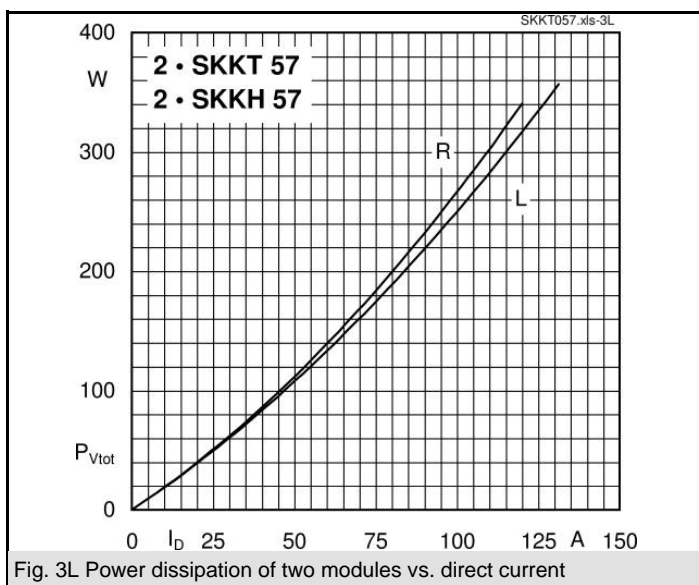
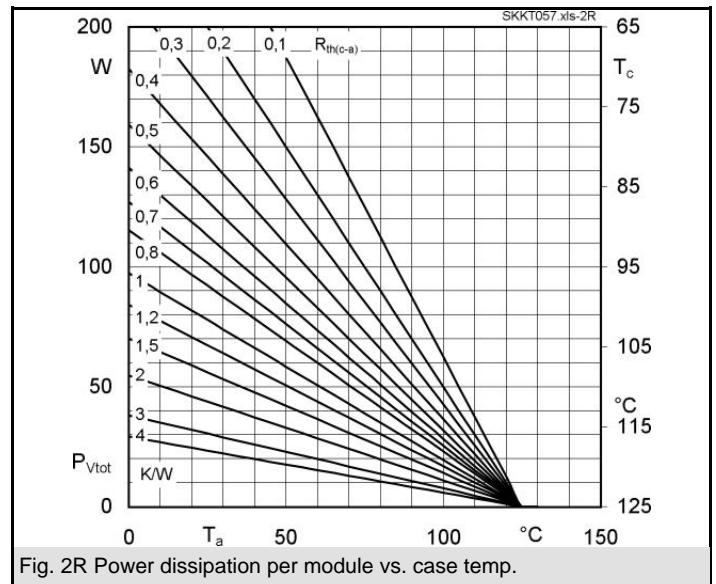
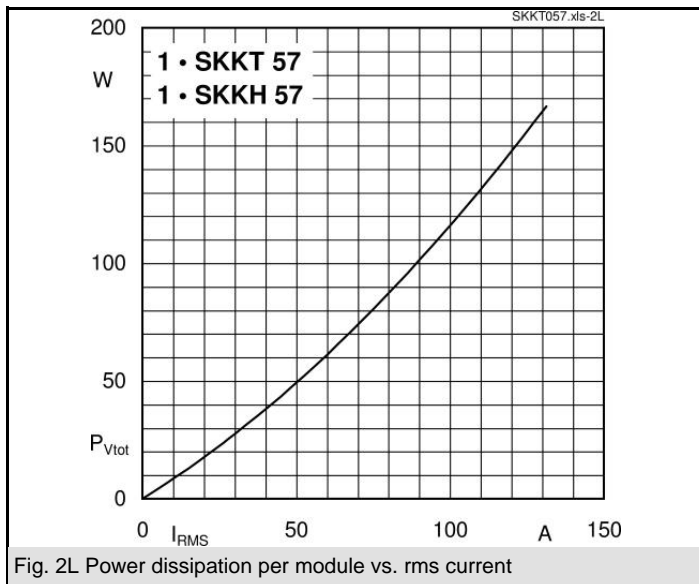
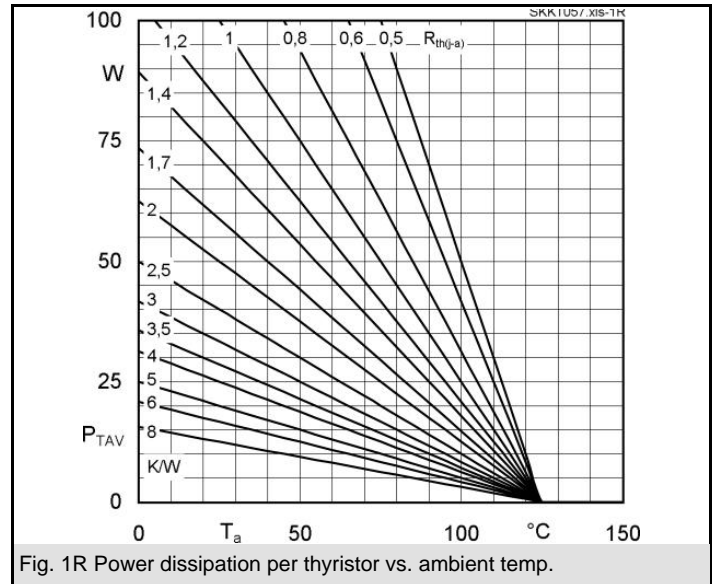
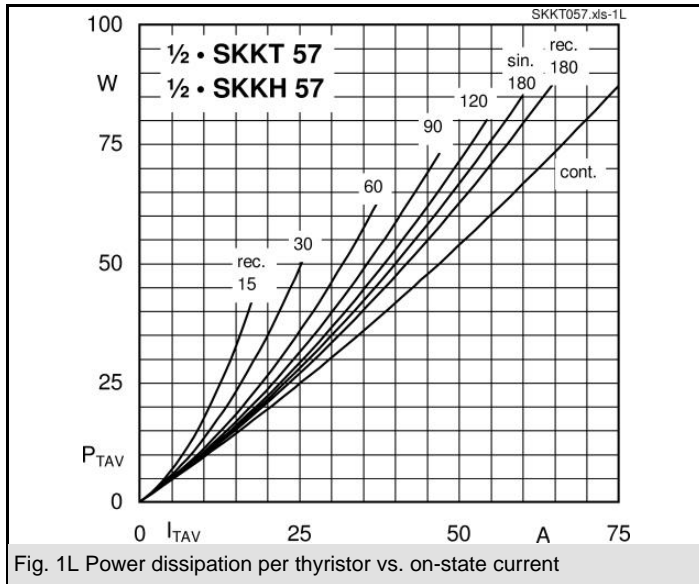

# SKKT 57, SKKH 57, SKKT 57B

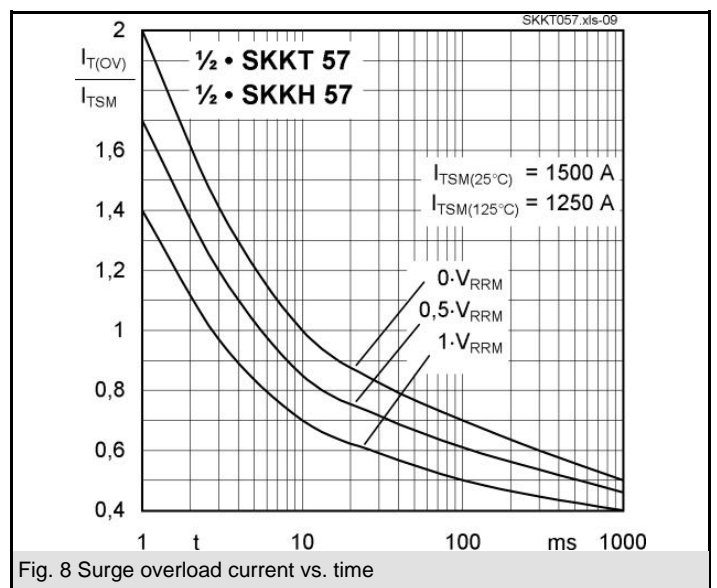
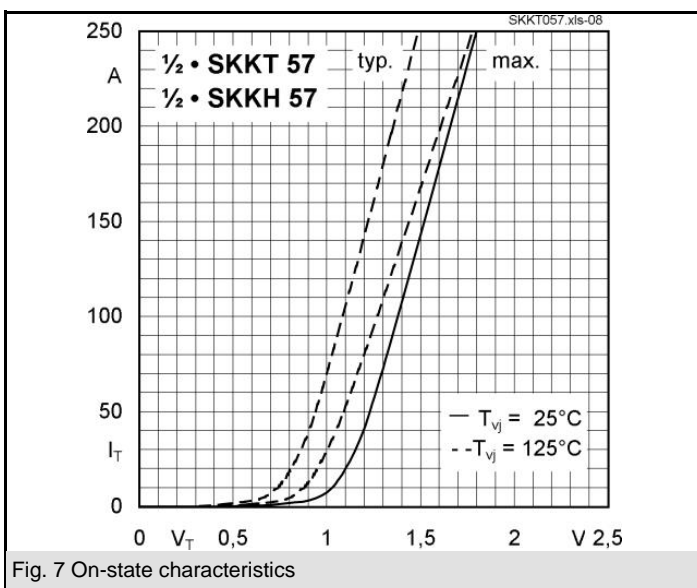
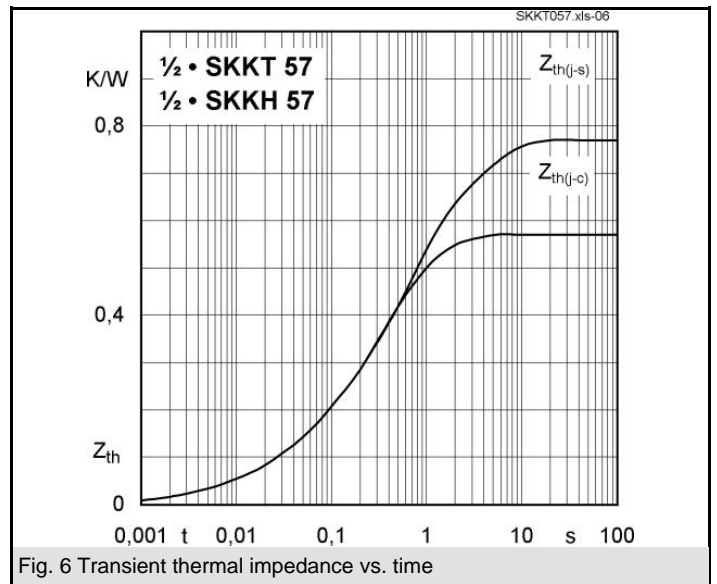
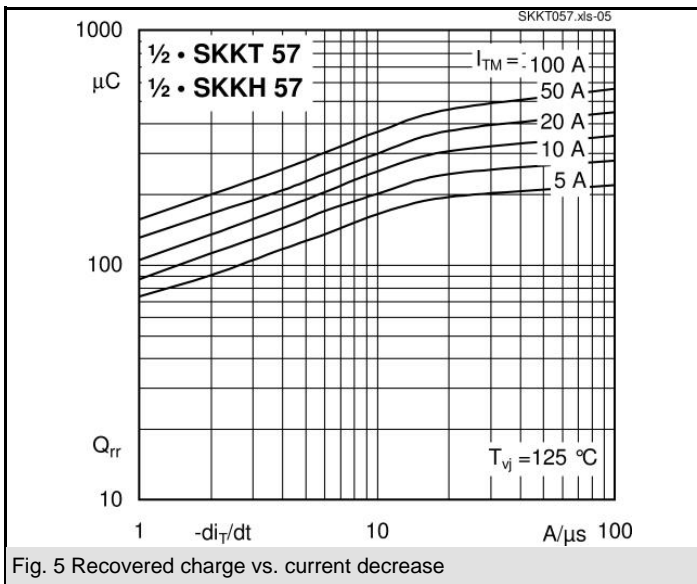
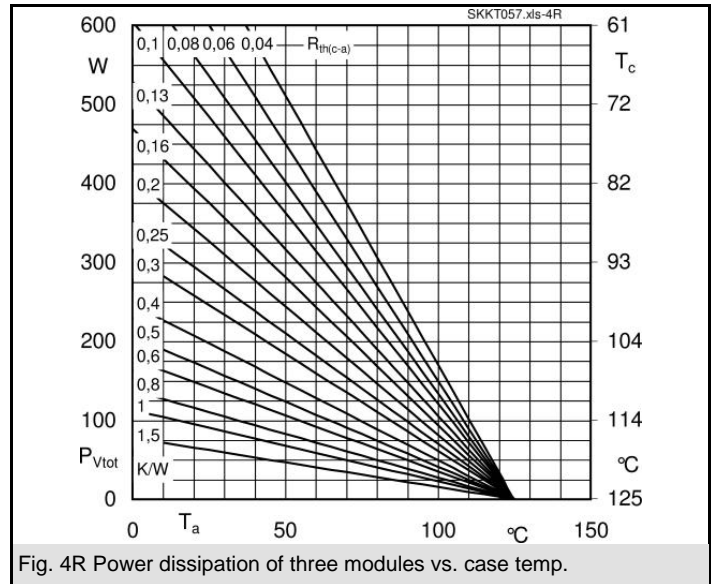
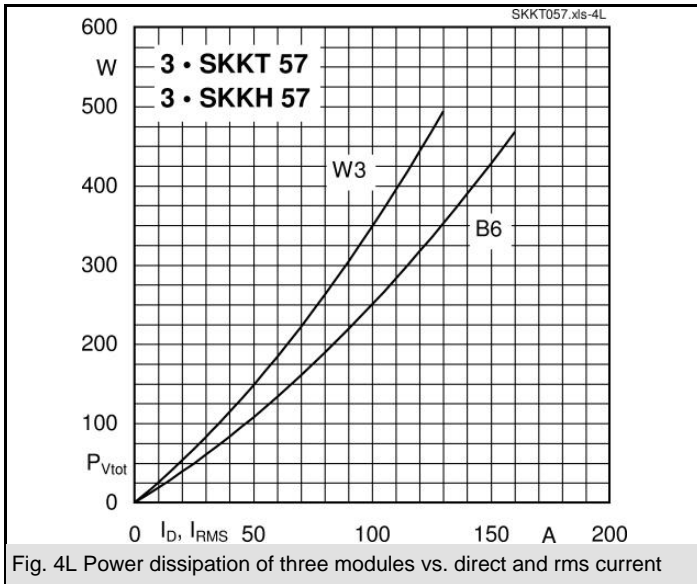

# SKKT 57, SKKH 57, SKKT 57B

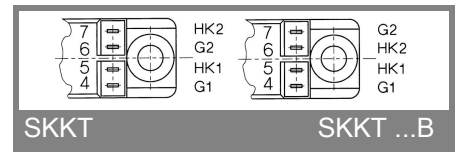
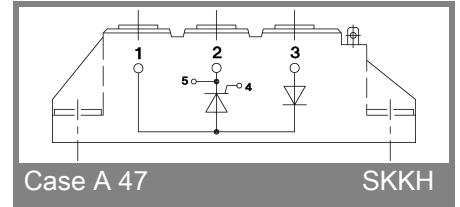
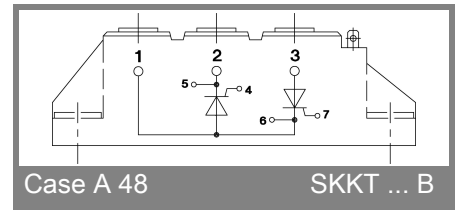
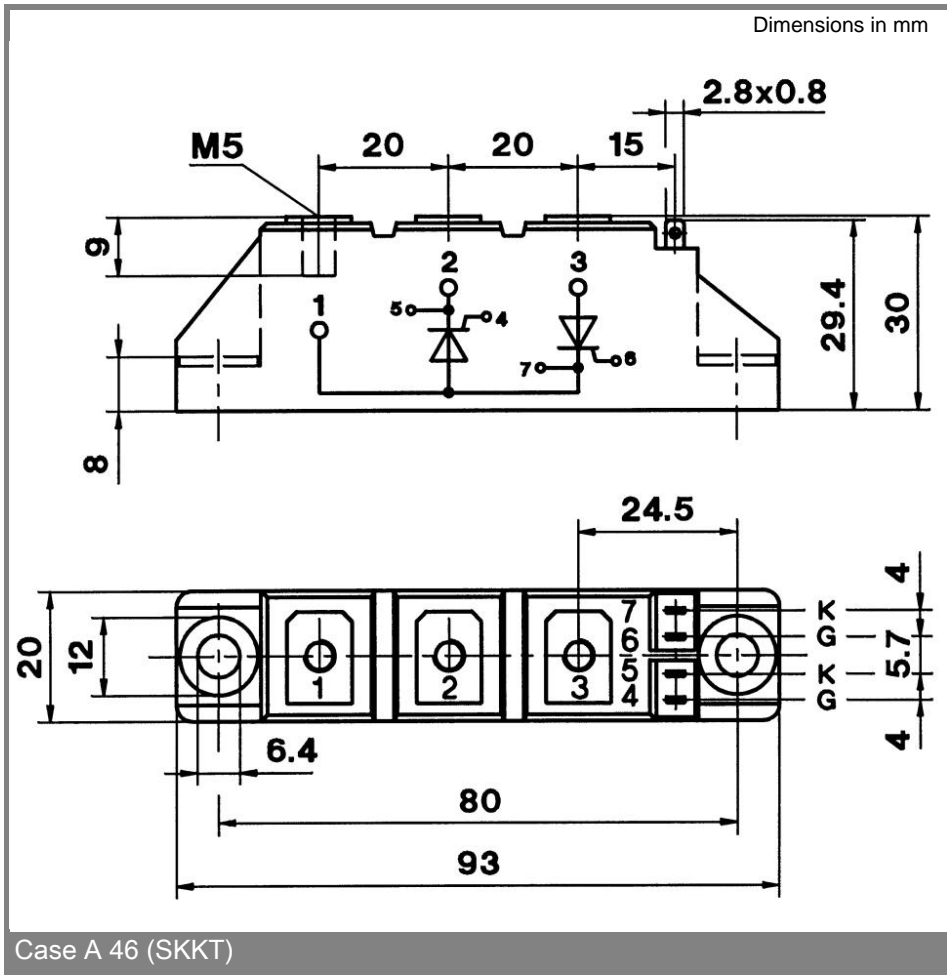

This technical information specifies semiconductor devices but promises no characteristics. No warranty or guarantee expressed or implied is made regarding delivery, performance or suitability.