

# SKM 121AR



**SEMITRANS™ M1**

## Power MOSFET Modules

### SKM 121AR

#### Features

- N Channel, enhancement mode
- Avalanche characteristics
- Short internal connections avoid oscillations
- Isolated copper baseplates
- All electrical connections on top for easy busbaring
- Large clearance (10mm) and creepage distances (13mm)
- UL recognized, file no. E 63 532

#### Typical Applications\*

- Switched mode power supplies
- DC servo and robot drives
- DC choppers
- UPS equipment
- Plasma cutting
- Not suitable for linear amplification



**MA**

Absolute Maximum Ratings		$T_c = 25\text{ °C}$ , unless otherwise specified	
Symbol	Conditions	Values	Units
$V_{DS}$		200	V
$I_D$	$T_s = 25\text{ (80) °C}$	130 (95)	A
$I_{DM}$	1 ms	390	A
$V_{GS}$		$\pm 20$	V
$T_{vj}$ ( $T_{stg}$ )		- 40 ... + 150 (125)	°C
$V_{isol}$	AC, 1 min.	2500	V
Inverse diode			
$I_F = -I_S$		130	A
$I_{FM} = -I_{SM}$		390	A

Characteristics		$T_c = 25\text{ °C}$ , unless otherwise specified			
Symbol	Conditions	min.	typ.	max.	Units
$V_{(BR)DSS}$	$V_{GS} = 0\text{ V}$ , $I_D = 0,25\text{ mA}$	200			V
$V_{GS(th)}$	$V_{GS} = V_{DS}$ , $I_D = 1\text{ mA}$	2,1	3	4	V
$I_{DSS}$	$V_{GS} = 0\text{ V}$ , $V_{DS} = 200\text{ V}$ , $T_j = 25\text{ (125) °C}$		50 (300)	250 (1000)	$\mu\text{A}$
$I_{GSS}$	$V_{GS} = 20\text{ V}$ , $V_{DS} = 0\text{ V}$		10	100	nA
$R_{DS(on)}$	$V_{GS} = 10\text{ V}$ , $I_D = 80\text{ A}$		18	20	m $\Omega$
$g_{fs}$	$V_{DS} = 25\text{ V}$ , $I_D = 80\text{ A}$	60	75		S
$C_{CHC}$	$V_{GS} = 0$ , $V_{DS} = 25\text{ V}$ , $f = 1\text{ MHz}$			160	pF
$C_{iss}$			10	13	nF
$C_{oss}$			3	4,5	nF
$C_{rss}$			0,7	1	nF
$L_{DS}$				20	nH
$t_{d(on)}$	$V_{DD} = 100\text{ V}$ , $I_D = 80\text{ A}$ ,		60		ns
$t_r$	$V_{GS} = 10\text{ V}$ , $R_G = 3,3\ \Omega$		60		ns
$t_{d(off)}$			240		ns
$t_f$			70		ns
Inverse diode					
$V_{SD}$	$I_F = 260\text{ A}$ ; $V_{GS} = 0\text{ V}$		1,05	1,4	V
$t_{rr}$	$T_j = 25\text{ (150) °C}$		400		ns
$Q_{rr}$	$T_j = 25\text{ °C}$		4,3		$\mu\text{C}$
$I_{rr}$	$T_j = \text{ °C}$				A
Thermal characteristics					
$R_{th(j-c)}$	per MOSFET			0,18	K/W
$R_{th(c-s)}$	$M_s$ , surface 10 $\mu\text{m}$ , per module			0,05	K/W
Mechanical data					
$M_s$	to heatsink (M6)	4		5	Nm
$M_t$	for terminals (M5)	2,5		3,5	Nm
w				130	g

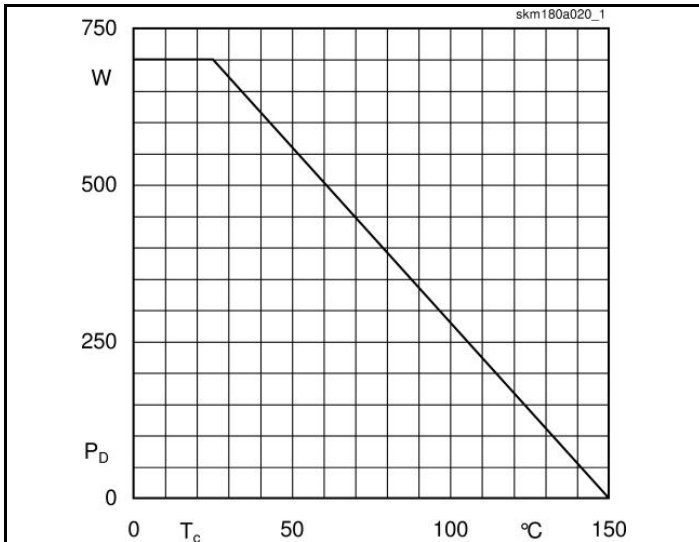

Fig. 1 Rated power dissipation vs. temperature

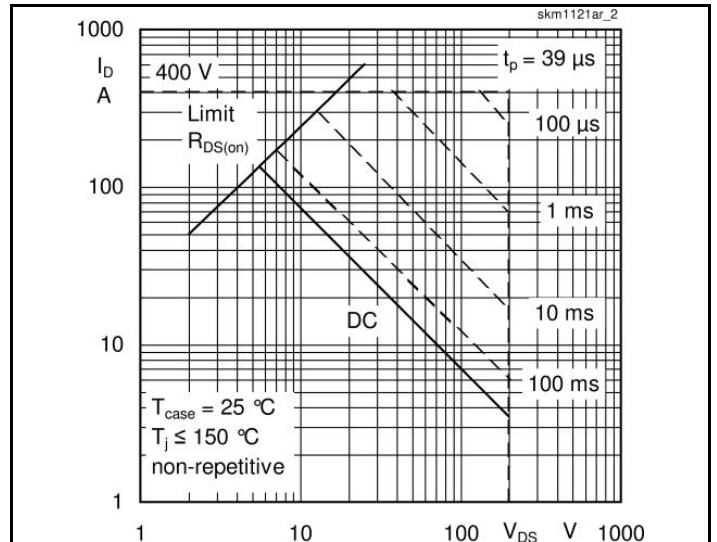

Fig. 2 Maximum safe operating area

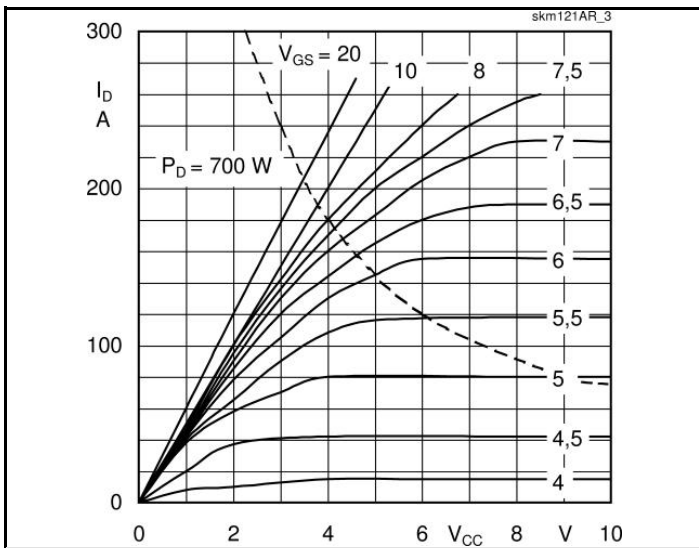

Fig. 3 Output characteristic

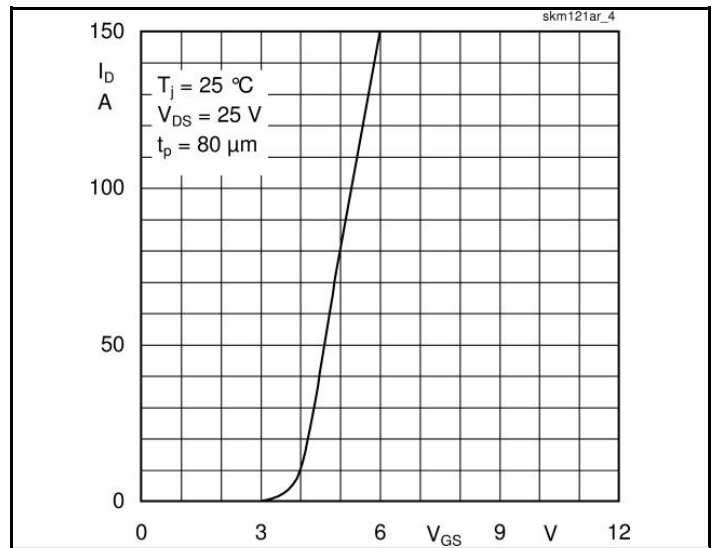

Fig. 4 Transfer characteristic

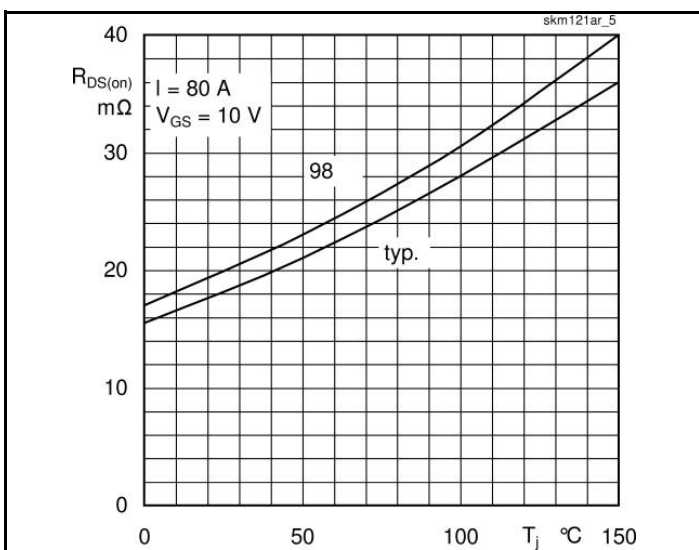

Fig. 5 On-resistance vs. temperature

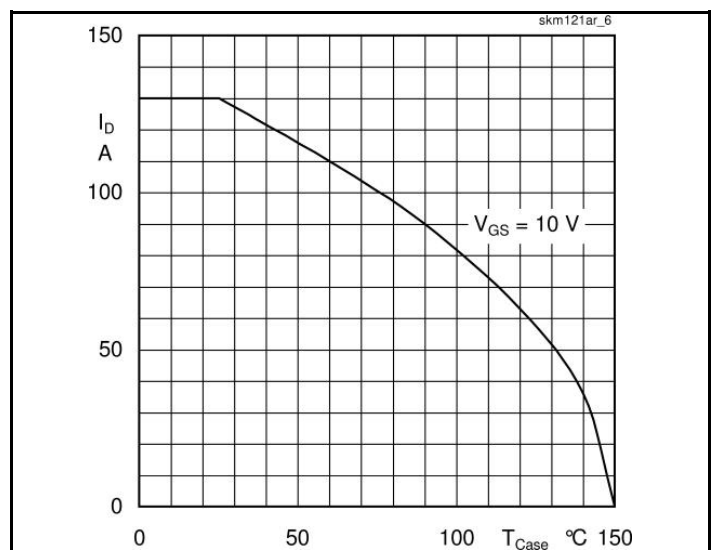
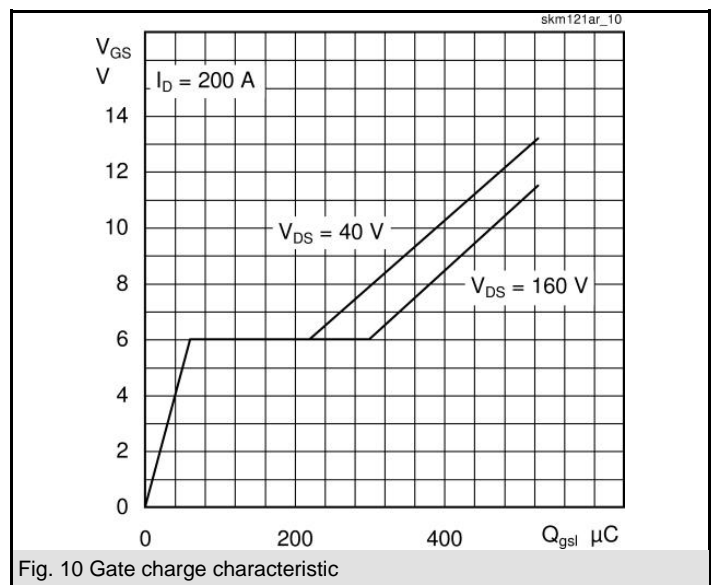
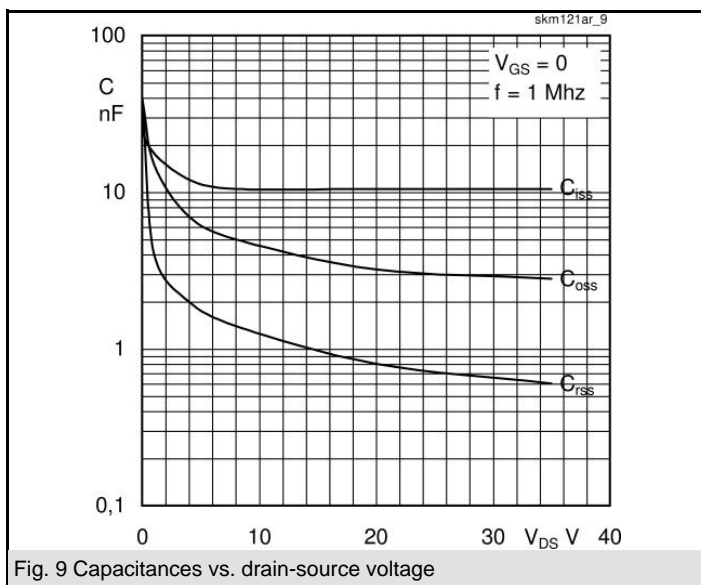
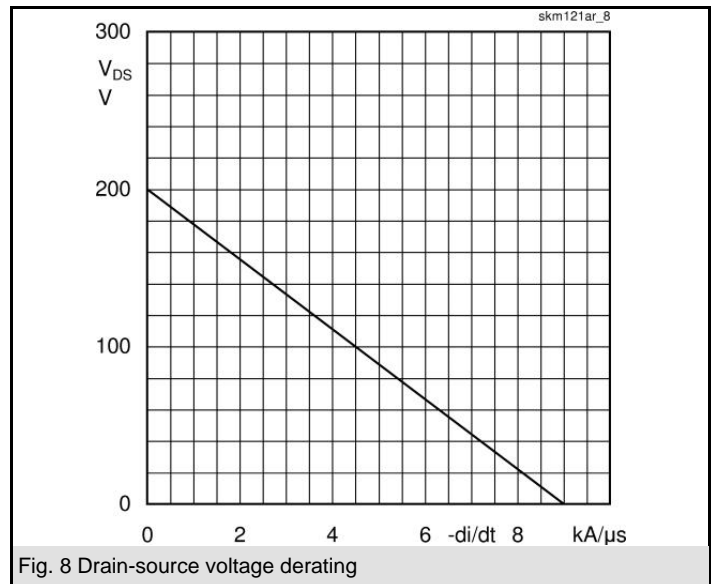
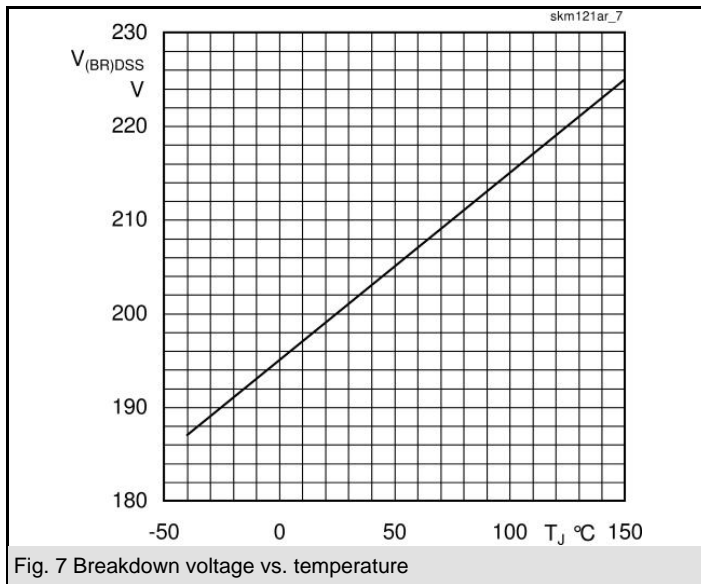

Fig. 6 Rated current vs. temperature



# SKM 121AR

UL Recognized  
File no. E 63 532

Dimensions in mm

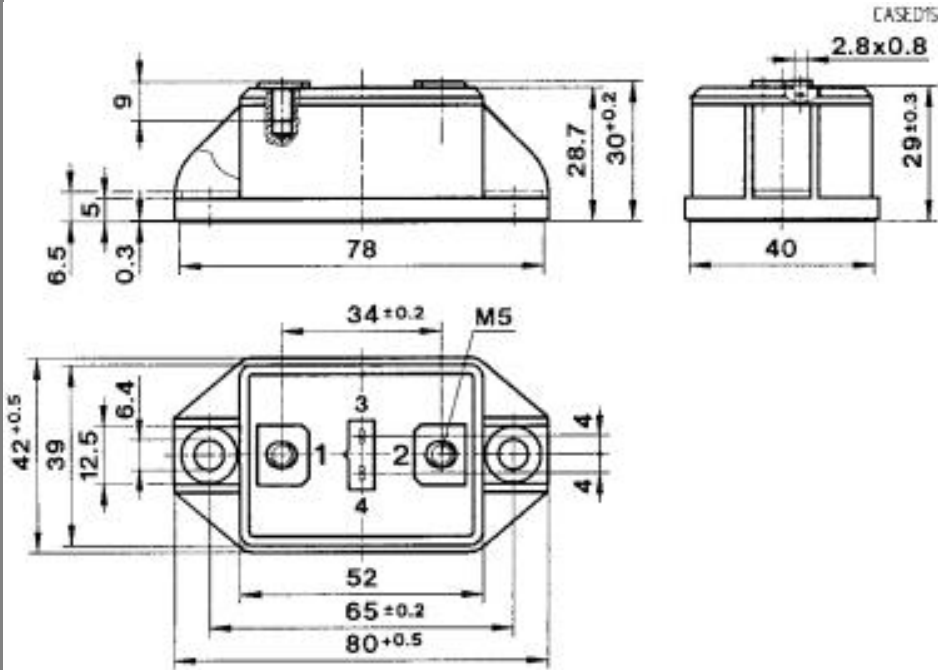

Case D 15

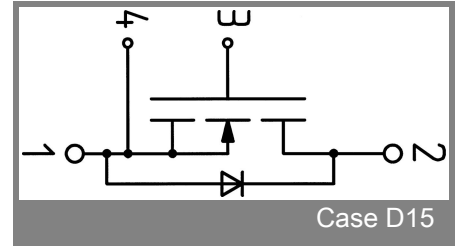

This is an electrostatic discharge sensitive device (ESDS), international standard IEC 60747-1, Chapter IX.

\* The specifications of our components may not be considered as an assurance of component characteristics. Components have to be tested for the respective application. Adjustments may be necessary. The use of SEMIKRON products in life support appliances and systems is subject to prior specification and written approval by SEMIKRON. We therefore strongly recommend prior consultation of our personal.