

SKM 200GB123D

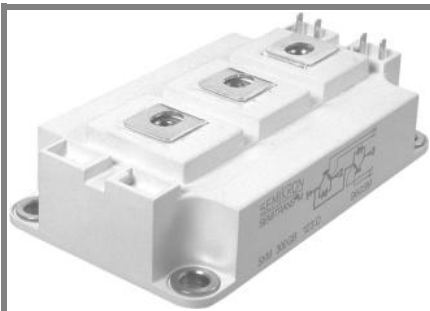

SEMITRANS® 3

IGBT Modules

SKM 200GB123D

SKM 200GAL123D

SKM 200GAR123D

Features

- MOS input (voltage controlled)
- N channel, homogeneous Si
- Low inductance case
- Very low tail current with low temperature dependence
- High short circuit capability, self limiting to $6 \times I_{Cnom}$
- Latch-up free
- Fast & soft inverse CAL diodes
- Isolated copper baseplate using DCB Direct Copper Bonding Technology
- Large clearance (13 mm) and creepage distances (20 mm)

Typical Applications*

- AC inverter drives
- UPS

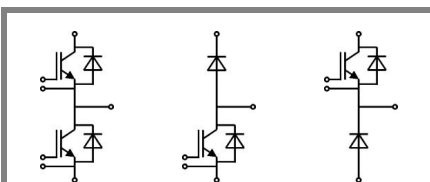

GB

GAL

GAR

Absolute Maximum Ratings		$T_C = 25\text{ °C}$, unless otherwise specified		
Symbol	Conditions	Values		Units
IGBT				
V_{CES}	$T_j = 25\text{ °C}$	1200		V
I_C	$T_j = 150\text{ °C}$	$T_{case} = 25\text{ °C}$	200	A
		$T_{case} = 85\text{ °C}$	180	A
I_{CRM}	$I_{CRM} = 2 \times I_{Cnom}$	300		A
V_{GES}		± 20		V
t_{psc}	$V_{CC} = 600\text{ V}; V_{GE} \leq 20\text{ V}; T_j = 125\text{ °C}$ $V_{CES} < 1200\text{ V}$	10		µs
Inverse Diode				
I_F	$T_j = 150\text{ °C}$	$T_{case} = 25\text{ °C}$	200	A
		$T_{case} = 80\text{ °C}$	130	A
I_{FRM}	$I_{FRM} = 2 \times I_{Fnom}$	300		A
I_{FSM}	$t_p = 10\text{ ms}; \sin.$	$T_j = 150\text{ °C}$	1440	A
Freewheeling Diode				
I_F	$T_j = 150\text{ °C}$	$T_{case} = 25\text{ °C}$	260	A
		$T_{case} = 80\text{ °C}$	180	A
I_{FRM}	$I_{FRM} = 2 \times I_{Fnom}$	400		A
I_{FSM}	$t_p = 10\text{ ms}; \sin.$	$T_j = 150\text{ °C}$	1800	A
Module				
$I_{t(RMS)}$		500		A
T_{vj}		- 40 ... + 150 (125)		°C
T_{stg}		- 40...+ 125		°C
V_{isol}	AC, 1 min.	2500		V

Characteristics		$T_C = 25\text{ °C}$, unless otherwise specified			
Symbol	Conditions	min.	typ.	max.	Units
IGBT					
$V_{GE(th)}$	$V_{GE} = V_{CE}, I_C = 6\text{ mA}$	4,5	5,5	6,5	V
I_{CES}	$V_{GE} = 0\text{ V}, V_{CE} = V_{CES}$		0,1	0,3	mA
V_{CE0}		$T_j = 25\text{ °C}$	1,4	1,6	V
		$T_j = 125\text{ °C}$	1,6	1,8	V
r_{CE}	$V_{GE} = 15\text{ V}$	$T_j = 25\text{ °C}$	7,33	9,33	mΩ
		$T_j = 125\text{ °C}$	10	12,66	mΩ
$V_{CE(sat)}$	$I_{Cnom} = 150\text{ A}, V_{GE} = 15\text{ V}$		2,5	3	V
C_{ies}	$V_{CE} = 25, V_{GE} = 0\text{ V}$	$f = 1\text{ MHz}$	10	13	nF
C_{oes}			1,5	2	nF
C_{res}			0,8	1,2	nF
Q_G	$V_{GE} = -8\text{ V} - +20\text{ V}$		1500		nC
R_{Gint}	$T_j = \text{°C}$		2,5		Ω
$t_{d(on)}$	$R_{Gon} = 5,6\text{ Ω}$	$V_{CC} = 600\text{ V}$ $I_C = 150\text{ A}$	220	400	ns
t_r			100	200	ns
E_{on}	$R_{Goff} = 5,6\text{ Ω}$	$T_j = 125\text{ °C}$ $V_{GE} = -15\text{ V}$	24		mJ
$t_{d(off)}$			600	800	ns
t_f			70	100	ns
E_{off}			17		mJ
$R_{th(j-c)}$	per IGBT			0,09	K/W

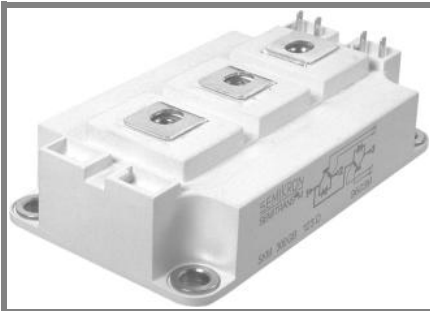

SEMITRANS® 3

IGBT Modules

SKM 200GB123D

SKM 200GAL123D

SKM 200GAR123D

Features

- MOS input (voltage controlled)
- N channel, homogeneous Si
- Low inductance case
- Very low tail current with low temperature dependence
- High short circuit capability, self limiting to $6 \times I_{cnom}$
- Latch-up free
- Fast & soft inverse CAL diodes
- Isolated copper baseplate using DCB Direct Copper Bonding Technology
- Large clearance (13 mm) and creepage distances (20 mm)

Typical Applications*

- AC inverter drives
- UPS

Characteristics					
Symbol	Conditions	min.	typ.	max.	Units
Inverse Diode					
$V_F = V_{EC}$	$I_{Fnom} = 150 \text{ A}; V_{GE} = 0 \text{ V}$	$T_j = 25 \text{ }^\circ\text{C}_{chiplev.}$	2	2,5	V
		$T_j = 125 \text{ }^\circ\text{C}_{chiplev.}$	1,8		V
V_{F0}		$T_j = 25 \text{ }^\circ\text{C}$	1,1	1,2	V
		$T_j = 125 \text{ }^\circ\text{C}$			V
r_F		$T_j = 25 \text{ }^\circ\text{C}$	6	8,7	mΩ
		$T_j = 125 \text{ }^\circ\text{C}$			mΩ
I_{RRM}	$I_F = 150 \text{ A}$	$T_j = 125 \text{ }^\circ\text{C}$	90		A
Q_{rr}	$di/dt = 1500 \text{ A}/\mu\text{s}$		8		μC
E_{rr}	$V_{GE} = -15 \text{ V}; V_{CC} = 600 \text{ V}$		6,6		mJ
$R_{th(j-c)D}$	per diode			0,25	K/W
Freewheeling Diode					
$V_F = V_{EC}$	$I_{Fnom} = 200 \text{ A}; V_{GE} = 0 \text{ V}$	$T_j = 25 \text{ }^\circ\text{C}_{chiplev.}$	2	2,5	V
		$T_j = 125 \text{ }^\circ\text{C}_{chiplev.}$	1,8		V
V_{F0}		$T_j = 25 \text{ }^\circ\text{C}$	1,1	1,2	V
		$T_j = 125 \text{ }^\circ\text{C}$			V
r_F		$T_j = 25 \text{ }^\circ\text{C}$	4,5	6,5	V
		$T_j = 125 \text{ }^\circ\text{C}$			V
I_{RRM}	$I_F = 200 \text{ A}$	$T_j = 125 \text{ }^\circ\text{C}$	120		A
Q_{rr}	$di/dt = 2000 \text{ A}/\mu\text{s}$		11		μC
E_{rr}	$V_{GE} = 0 \text{ V}; V_{CC} = 600 \text{ V}$				mJ
$R_{th(j-c)FD}$	per diode			0,18	K/W
Module					
L_{CE}			15	20	nH
$R_{CC'+EE'}$	res., terminal-chip	$T_{case} = 25 \text{ }^\circ\text{C}$	0,35		mΩ
		$T_{case} = 125 \text{ }^\circ\text{C}$	0,5		mΩ
$R_{th(c-s)}$	per module			0,038	K/W
M_s	to heat sink M6		3	5	Nm
M_t	to terminals M6, M4		2,5	5	Nm
w				325	g

This is an electrostatic discharge sensitive device (ESDS), international standard IEC 60747-1, Chapter IX.

* The specifications of our components may not be considered as an assurance of component characteristics. Components have to be tested for the respective application. Adjustments may be necessary. The use of SEMIKRON products in life support appliances and systems is subject to prior specification and written approval by SEMIKRON. We therefore strongly recommend prior consultation of our personal.

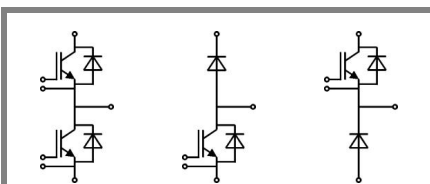

GB

GAL

GAR

SKM 200GB123D

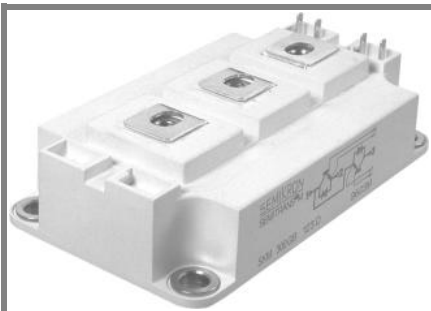

SEMITRANS® 3

IGBT Modules

SKM 200GB123D

SKM 200GAL123D

SKM 200GAR123D

Features

- MOS input (voltage controlled)
- N channel, homogeneous Si
- Low inductance case
- Very low tail current with low temperature dependence
- High short circuit capability, self limiting to $6 \times I_{cnom}$
- Latch-up free
- Fast & soft inverse CAL diodes
- Isolated copper baseplate using DCB Direct Copper Bonding Technology
- Large clearance (13 mm) and creepage distances (20 mm)

Typical Applications*

- AC inverter drives
- UPS

Z_{th}		Conditions	Values	Units
$Z_{th(j-c)I}$				
R_{θ}	$i = 1$		59	mk/W
R_{θ}	$i = 2$		23	mk/W
R_{θ}	$i = 3$		6,8	mk/W
R_{θ}	$i = 4$		1,2	mk/W
τ_{θ}	$i = 1$		0,03	s
τ_{θ}	$i = 2$		0,0087	s
τ_{θ}	$i = 3$		0,002	s
τ_{θ}	$i = 4$		0,0002	s
$Z_{th(j-c)D}$				
R_{θ}	$i = 1$		170	mk/W
R_{θ}	$i = 2$		66	mk/W
R_{θ}	$i = 3$		12	mk/W
R_{θ}	$i = 4$		2	mk/W
τ_{θ}	$i = 1$		0,0348	s
τ_{θ}	$i = 2$		0,0072	s
τ_{θ}	$i = 3$		0,077	s
τ_{θ}	$i = 4$		0,0002	s

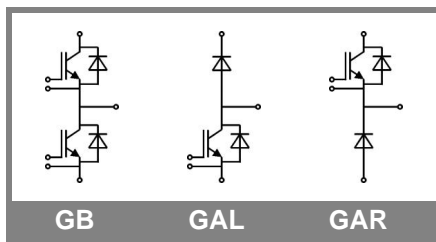

GB

GAL

GAR

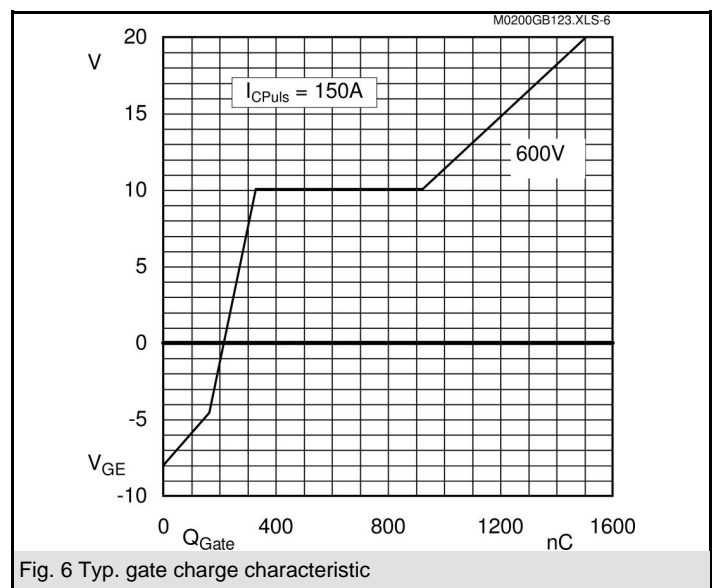
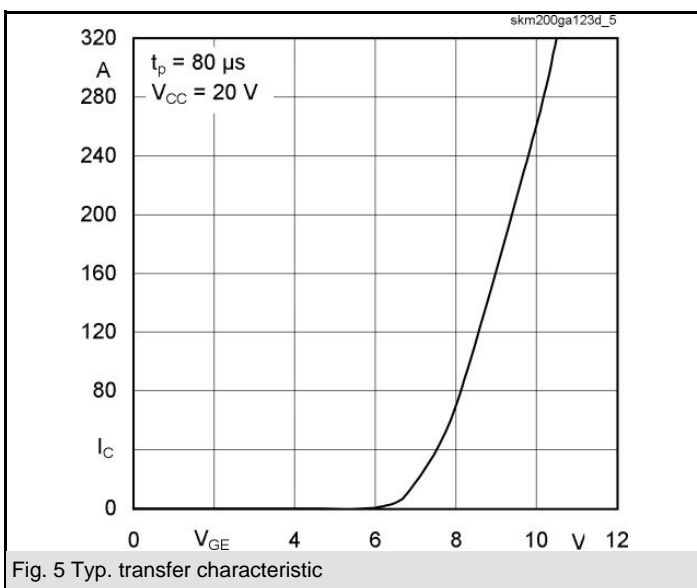
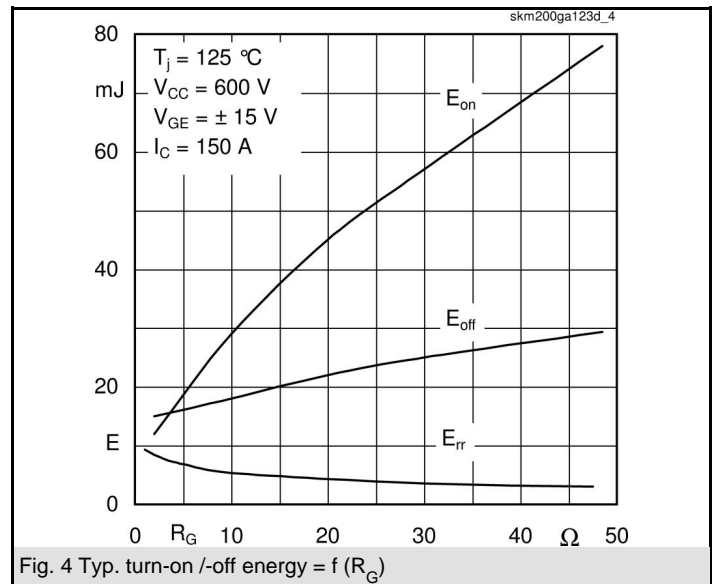
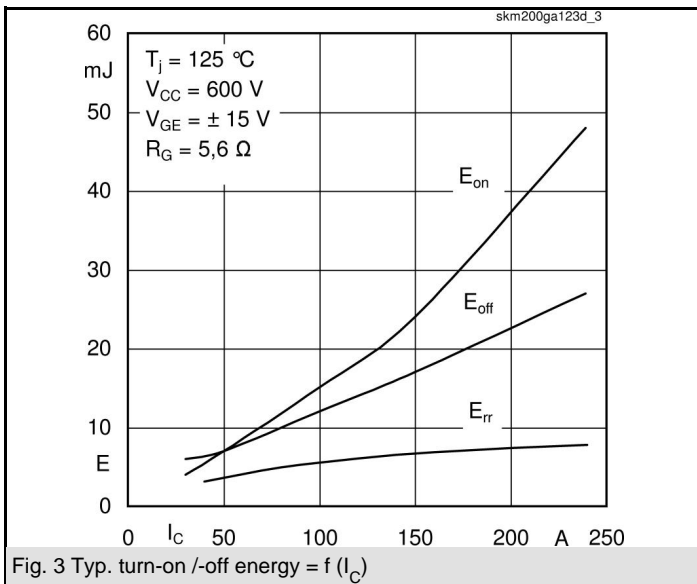
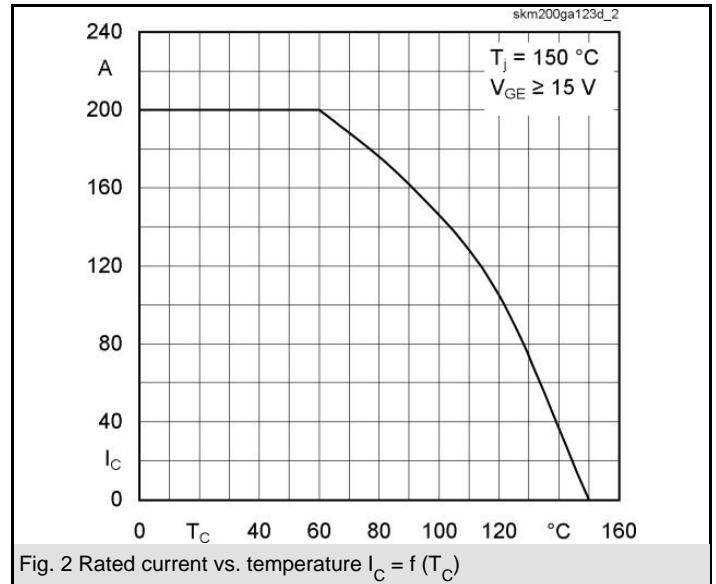
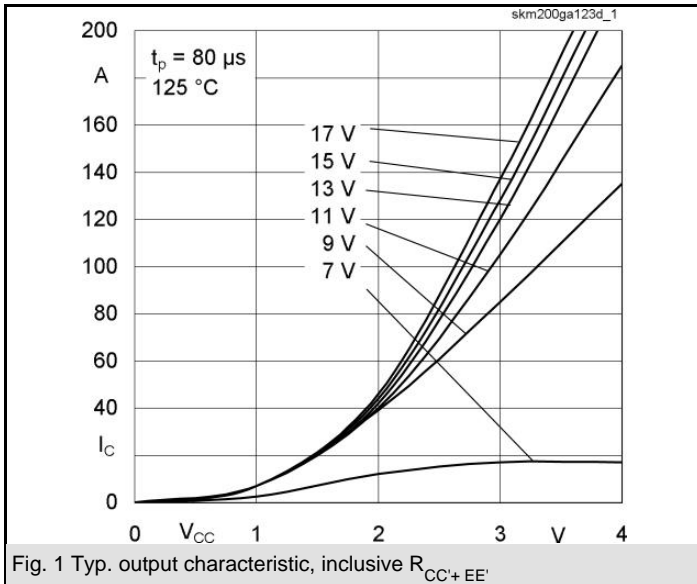

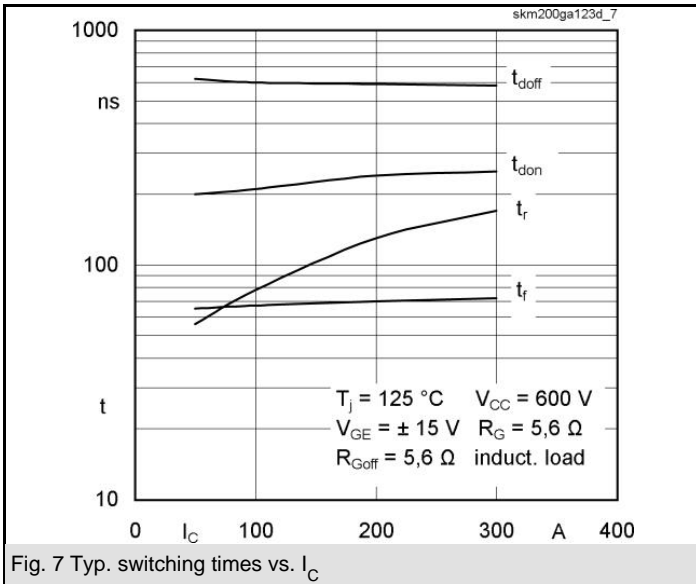

Fig. 7 Typ. switching times vs. I_C

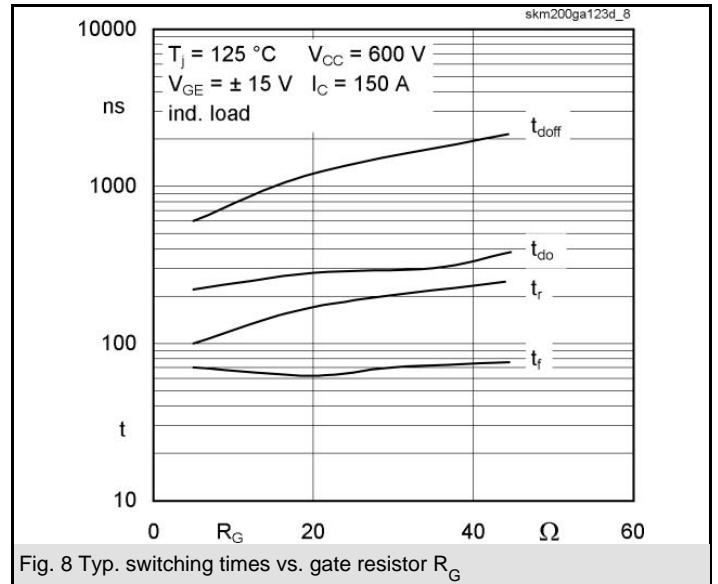

Fig. 8 Typ. switching times vs. gate resistor R_G

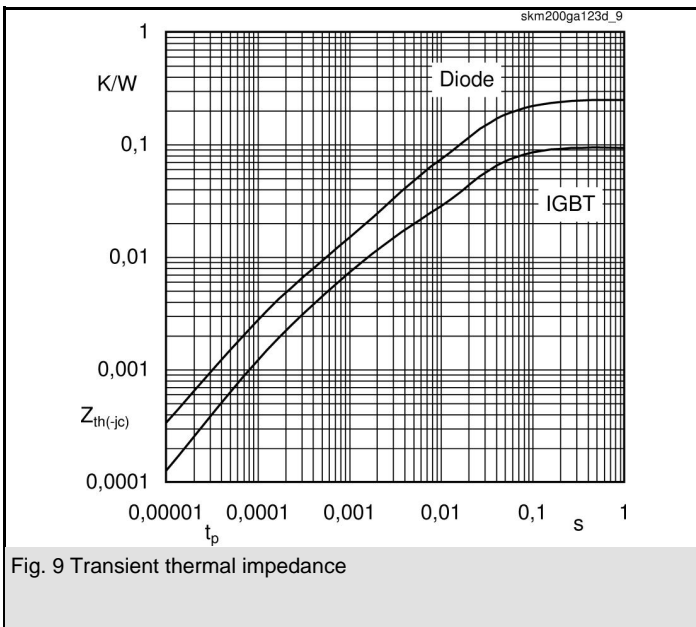

Fig. 9 Transient thermal impedance

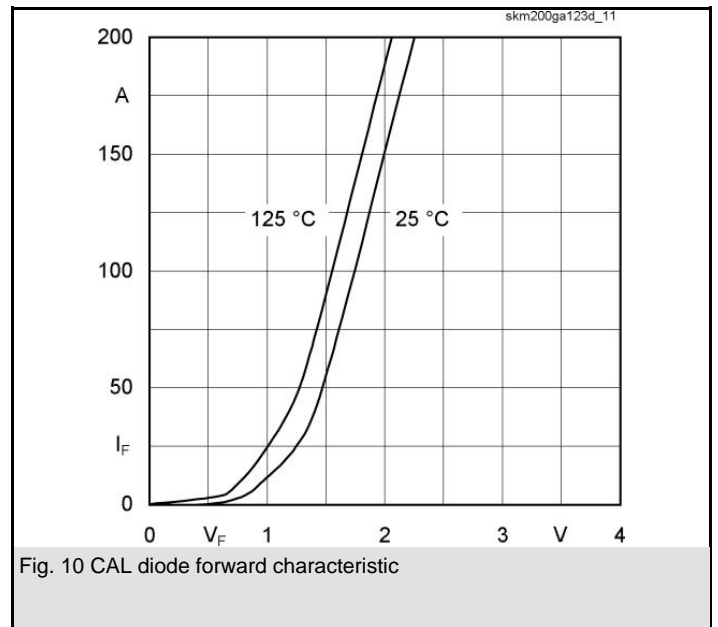

Fig. 10 CAL diode forward characteristic

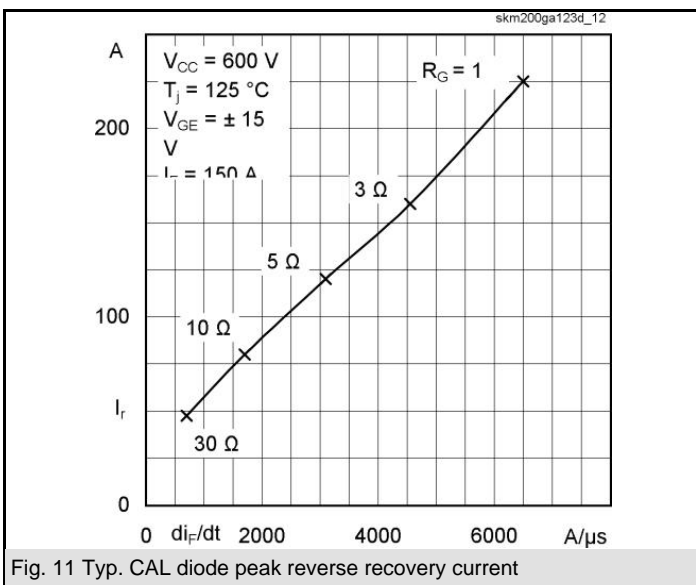

Fig. 11 Typ. CAL diode peak reverse recovery current

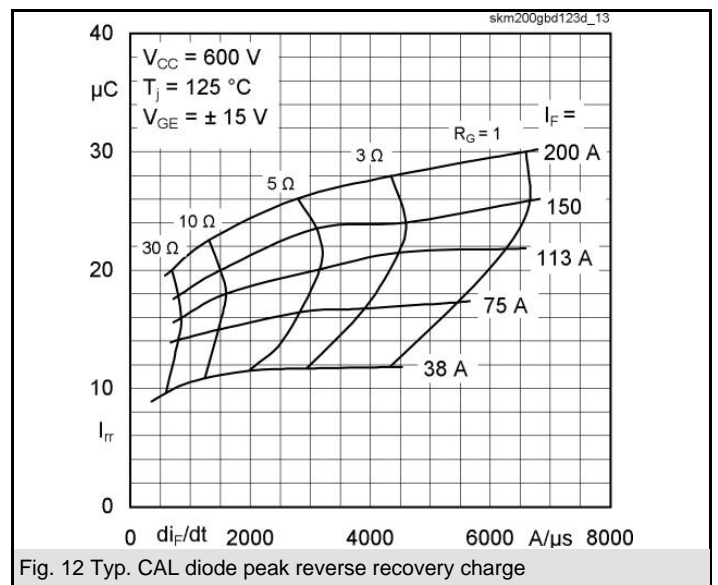

Fig. 12 Typ. CAL diode peak reverse recovery charge

SKM 200GB123D

UL Recognized

CASED56

File 63 532

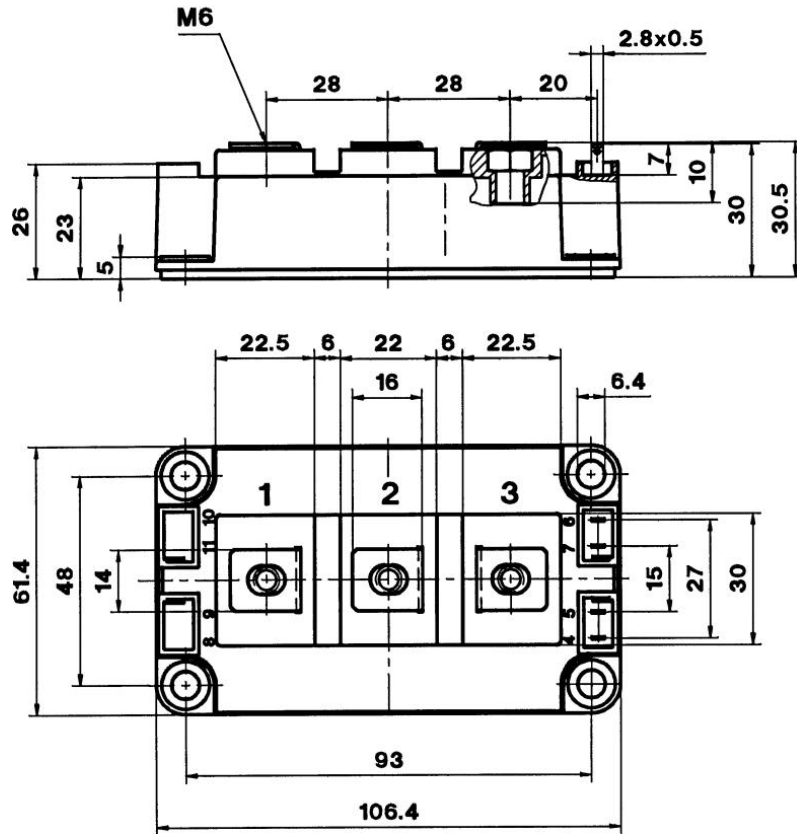

Case D 56

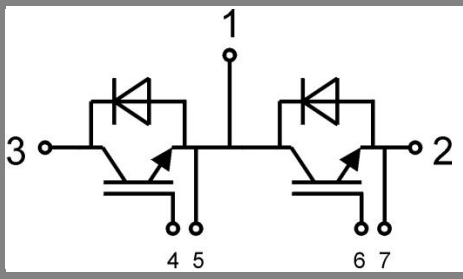

Case D 56

GB

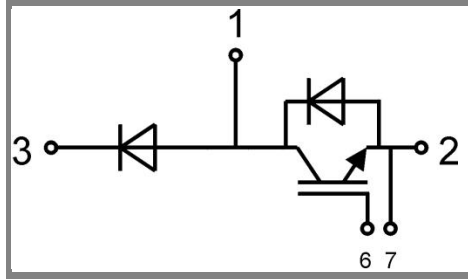

Case D 57

GAL

(56)

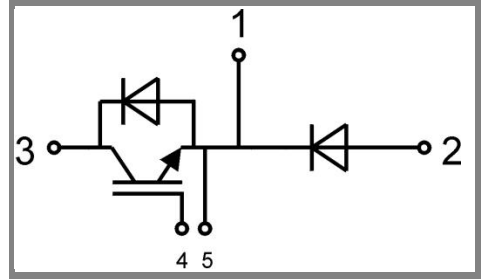

Case D 58

GAR

(56)