

# SKM 300GB063D

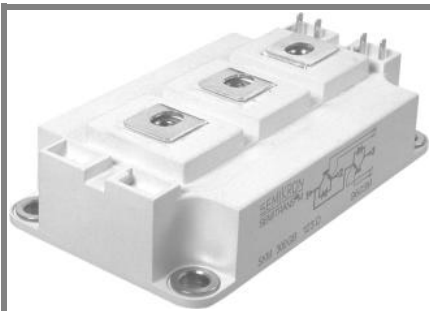

**SEMITRANS® 3**

## Superfast IGBT Modules

**SKM 300GB063D**

**SKM 300GAR063D**

**SKM 300GAL063D**

### Features

- NPT- Non punch-through IGBT
- Low tail current with low temperature dependence
- High short circuit capability, self limiting if term. G is clamped to E
- Pos. temp.-coeff. of  $V_{CEsat}$
- 50 % less turn off losses
- 30 % less short circuit current
- Very low  $C_{ies}$ ,  $C_{oes}$ ,  $C_{res}$
- Latch-up free
- Fast & soft inverse CAL diodes
- Isolated copper baseplate using DCB Direct Copper Bonding Technology without hard mould
- Large clearance (13 mm) and creepage distances (20 mm)

### Typical Applications\*

- Switching (not for linear use)
- Switched mode power supplies
- AC inverter servo drives
- UPS uninterruptable power supplies
- Welding inverters

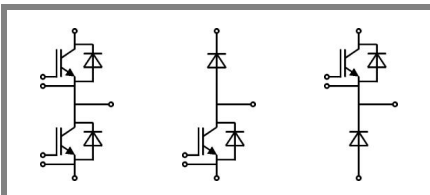

GB

GAL

GAR

Absolute Maximum Ratings		$T_c = 25\text{ °C}$ , unless otherwise specified		
Symbol	Conditions	Values		Units
<b>IGBT</b>				
$V_{CES}$	$T_j = 25\text{ °C}$	600		V
$I_C$	$T_j = 150\text{ °C}$	$T_{case} = 25\text{ °C}$	400	A
		$T_{case} = 70\text{ °C}$	300	A
$I_{CRM}$	$I_{CRM} = 2 \times I_{Cnom}$	600		A
$V_{GES}$		± 20		V
$t_{psc}$	$V_{CC} = 300\text{ V}$ ; $V_{GE} \leq 20\text{ V}$ ; $T_j = 125\text{ °C}$ $V_{CES} < 600\text{ V}$	10		µs
<b>Inverse Diode</b>				
$I_F$	$T_j = 150\text{ °C}$	$T_{case} = 25\text{ °C}$	250	A
		$T_{case} = 80\text{ °C}$	170	A
$I_{FRM}$	$I_{FRM} = 2 \times I_{Fnom}$	600		A
$I_{FSM}$	$t_p = 10\text{ ms}$ ; sin.	$T_j = 150\text{ °C}$	1600	A
<b>Freewheeling Diode</b>				
$I_F$	$T_j = 150\text{ °C}$	$T_c = 25\text{ °C}$	400	A
		$T_c = 80\text{ °C}$	270	A
$I_{FRM}$	$I_{FRM} = 2 \times I_{Fnom}$	800		A
$I_{FSM}$	$t_p = 10\text{ ms}$ ; sin.	$T_j = 150\text{ °C}$	2800	A
<b>Module</b>				
$I_{t(RMS)}$		500		A
$T_{vj}$		- 40 ... + 150		°C
$T_{stg}$		- 40 ... + 125		°C
$V_{isol}$	AC, 1 min.	2500		V

Characteristics		$T_c = 25\text{ °C}$ , unless otherwise specified			
Symbol	Conditions	min.	typ.	max.	Units
<b>IGBT</b>					
$V_{GE(th)}$	$V_{GE} = V_{CE}$ , $I_C = 6\text{ mA}$	4,5	5,5	6,5	V
$I_{CES}$	$V_{GE} = 0\text{ V}$ , $V_{CE} = V_{CES}$		0,2	0,6	mA
$V_{CE0}$		$T_j = 25\text{ °C}$	1,05		V
		$T_j = 125\text{ °C}$	1		V
$r_{CE}$	$V_{GE} = 15\text{ V}$	$T_j = 25\text{ °C}$	3,2		mΩ
		$T_j = 125\text{ °C}$	4,7		mΩ
$V_{CE(sat)}$	$I_{Cnom} = 300\text{ A}$ , $V_{GE} = 15\text{ V}$	$T_j = 25\text{ °C}_{chiplev.}$	2,1	2,5	V
		$T_j = 125\text{ °C}_{chiplev.}$	2,4	2,8	V
$C_{ies}$	$V_{CE} = 25$ , $V_{GE} = 0\text{ V}$	$f = 1\text{ MHz}$	17		nF
$C_{oes}$			2		nF
$C_{res}$			1,2		nF
$Q_G$	$V_{GE} = 0\text{ V} \dots 15\text{ V}$	720		nC	
$R_{Gint}$	$T_j = \text{°C}$	0		Ω	
$t_{d(on)}$	$R_{Gon} = 6\text{ Ω}$	$V_{CC} = 300\text{ V}$ $I_C = 300\text{ A}$	160		ns
$t_r$			80		ns
$E_{on}$	$R_{Goff} = 6\text{ Ω}$	$T_j = 125\text{ °C}$ $V_{GE} = \pm 15\text{ V}$	14		mJ
$t_{d(off)}$			550		ns
$t_f$			50		ns
$E_{off}$			13		mJ
$R_{th(j-c)}$	per IGBT			0,09	K/W

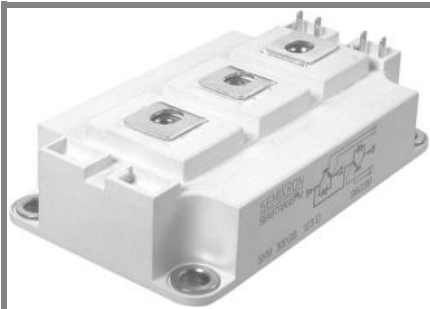

**SEMITRANS® 3**

## Superfast IGBT Modules

**SKM 300GB063D**

**SKM 300GAR063D**

**SKM 300GAL063D**

### Features

- NPT- Non punch-through IGBT
- Low tail current with low temperature dependence
- High short circuit capability, self limiting if term. G is clamped to E
- Pos. temp.-coeff. of  $V_{CEsat}$
- 50 % less turn off losses
- 30 % less short circuit current
- Very low  $C_{ies}$ ,  $C_{oes}$ ,  $C_{res}$
- Latch-up free
- Fast & soft inverse CAL diodes
- Isolated copper baseplate using DCB Direct Copper Bonding Technology without hard mould
- Large clearance (13 mm) and creepage distances (20 mm)

### Typical Applications\*

- Switching (not for linear use)
- Switched mode power supplies
- AC inverter servo drives
- UPS uninterruptable power supplies
- Welding inverters

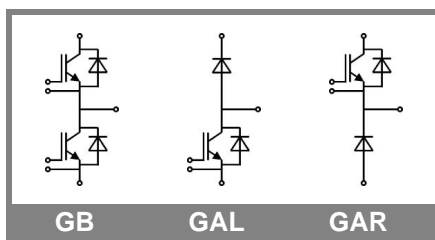

Characteristics					
Symbol	Conditions	min.	typ.	max.	Units
<b>Inverse Diode</b>					
$V_F = V_{EC}$	$I_{Fnom} = 300 \text{ A}; V_{GE} = 0 \text{ V}$	$T_j = 25 \text{ }^\circ\text{C}_{chiplev.}$	1,65	2	V
		$T_j = 125 \text{ }^\circ\text{C}_{chiplev.}$	1,65	2	V
$V_{F0}$		$T_j = 125 \text{ }^\circ\text{C}$		0,9	V
$r_F$		$T_j = 125 \text{ }^\circ\text{C}$	3	3,7	m $\Omega$
$I_{RRM}$	$I_F = 300 \text{ A}$	$T_j = 125 \text{ }^\circ\text{C}$	120		A
$Q_{rr}$			18		$\mu\text{C}$
$E_{rr}$	$V_{GE} = -15 \text{ V}; V_{CC} = 300 \text{ V}$				mJ
$R_{th(j-c)D}$	per diode			0,25	K/W
<b>Freewheeling Diode</b>					
$V_F = V_{EC}$	$I_{Fnom} = 400 \text{ A}; V_{GE} = 0 \text{ V}$	$T_j = 25 \text{ }^\circ\text{C}_{chiplev.}$	1,65	2	V
		$T_j = 125 \text{ }^\circ\text{C}_{chiplev.}$	1,65	2	V
$V_{F0}$		$T_j = 125 \text{ }^\circ\text{C}$		0,9	V
$r_F$		$T_j = 125 \text{ }^\circ\text{C}$		3	V
$I_{RRM}$	$I_F = 300 \text{ A}$	$T_j = 125 \text{ }^\circ\text{C}$	130		A
$Q_{rr}$			23		$\mu\text{C}$
$E_{rr}$	$V_{GE} = -15 \text{ V}; V_{CC} = 300 \text{ V}$				mJ
$R_{th(j-c)FD}$	per diode			0,15	K/W
<b>Module</b>					
$L_{CE}$			15	20	nH
$R_{CC+EE'}$	res., terminal-chip	$T_{case} = 25 \text{ }^\circ\text{C}$	0,35		m $\Omega$
		$T_{case} = 125 \text{ }^\circ\text{C}$	0,5		m $\Omega$
$R_{th(c-s)}$	per module			0,038	K/W
$M_s$	to heat sink M6		3	5	Nm
$M_t$	to terminals M6		2,5	5	Nm
w				325	g

This is an electrostatic discharge sensitive device (ESDS), international standard IEC 60747-1, Chapter IX.

\* The specifications of our components may not be considered as an assurance of component characteristics. Components have to be tested for the respective application. Adjustments may be necessary. The use of SEMIKRON products in life support appliances and systems is subject to prior specification and written approval by SEMIKRON. We therefore strongly recommend prior consultation of our personal.

# SKM 300GB063D

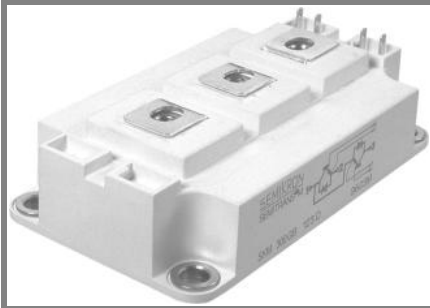

**SEMITRANS® 3**

## Superfast IGBT Modules

**SKM 300GB063D**

**SKM 300GAR063D**

**SKM 300GAL063D**

### Features

- NPT- Non punch-through IGBT
- Low tail current with low temperature dependence
- High short circuit capability, self limiting if term. G is clamped to E
- Pos. temp.-coeff. of  $V_{CEsat}$
- 50 % less turn off losses
- 30 % less short circuit current
- Very low  $C_{ies}$ ,  $C_{oes}$ ,  $C_{res}$
- Latch-up free
- Fast & soft inverse CAL diodes
- Isolated copper baseplate using DCB Direct Copper Bonding Technology without hard mould
- Large clearance (13 mm) and creepage distances (20 mm)

### Typical Applications\*

- Switching (not for linear use)
- Switched mode power supplies
- AC inverter servo drives
- UPS uninterruptable power supplies
- Welding inverters

$Z_{th}$		Conditions	Values	Units
<b><math>Z_{th(j-c)I}</math></b>				
$R_{\theta j-c}$		$i = 1$	65	mk/W
$R_{\theta j-c}$		$i = 2$	19	mk/W
$R_{\theta j-c}$		$i = 3$	4,7	mk/W
$R_{\theta j-c}$		$i = 4$	1,3	mk/W
$\tau_{th(j-c)}$		$i = 1$	0,0518	s
$\tau_{th(j-c)}$		$i = 2$	0,0241	s
$\tau_{th(j-c)}$		$i = 3$	0,0021	s
$\tau_{th(j-c)}$		$i = 4$	0,0001	s
<b><math>Z_{th(j-c)D}</math></b>				
$R_{\theta j-cD}$		$i = 1$	140	mk/W
$R_{\theta j-cD}$		$i = 2$	85	mk/W
$R_{\theta j-cD}$		$i = 3$	20,55	mk/W
$R_{\theta j-cD}$		$i = 4$	4,45	mk/W
$\tau_{th(j-c)D}$		$i = 1$	0,0613	s
$\tau_{th(j-c)D}$		$i = 2$	0,0041	s
$\tau_{th(j-c)D}$		$i = 3$	0,0045	s
$\tau_{th(j-c)D}$		$i = 4$	0,0003	s

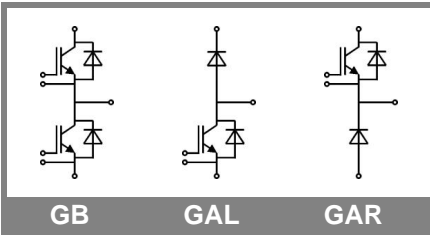

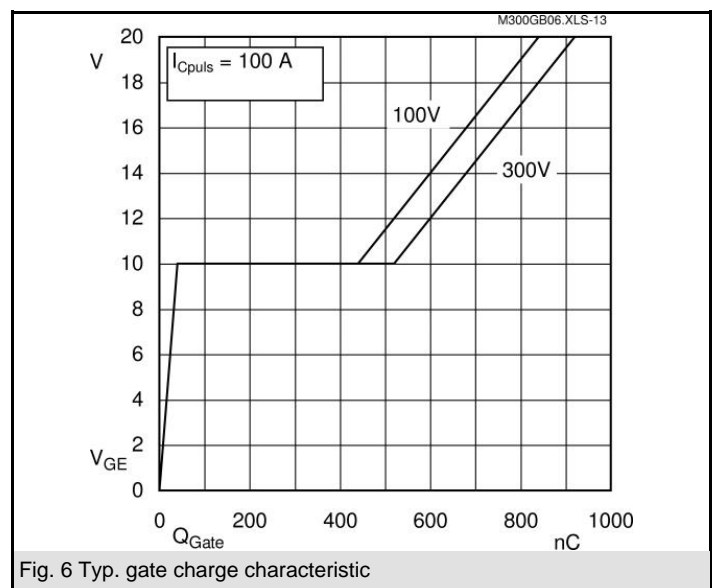
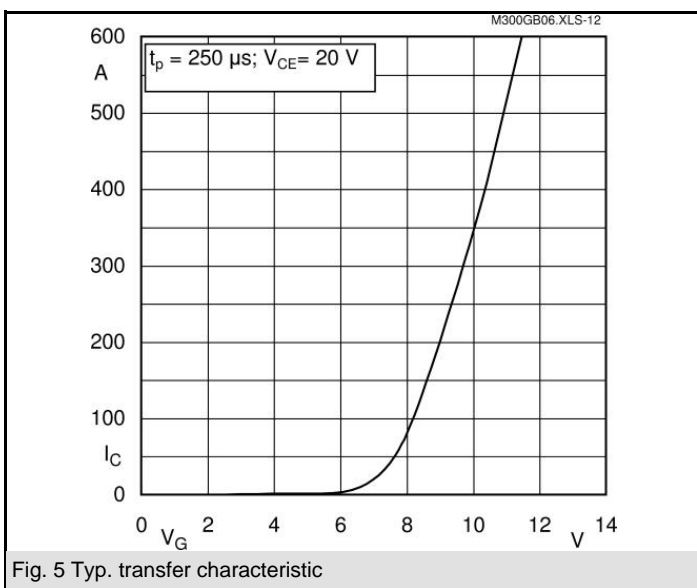
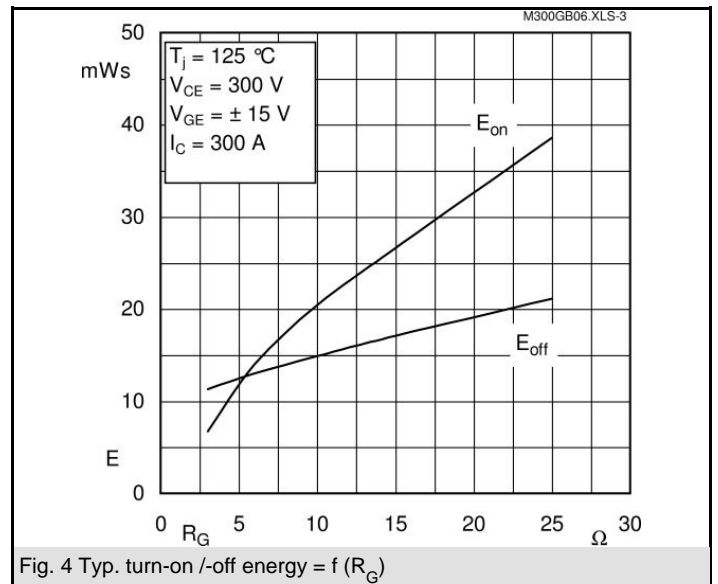
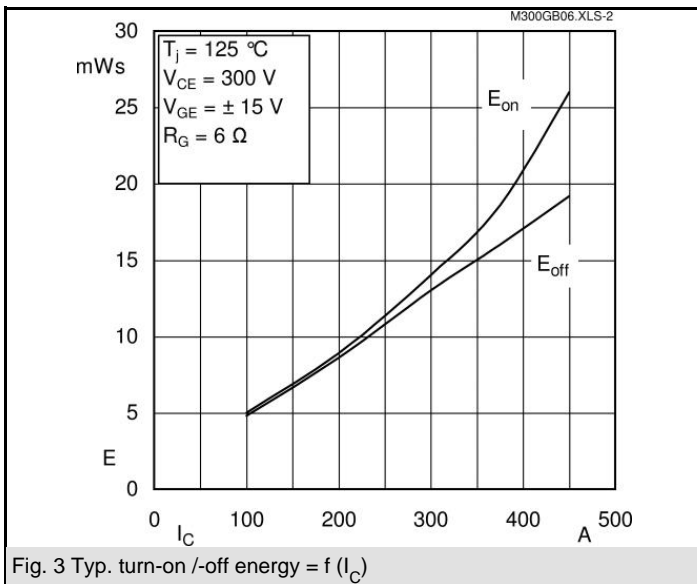
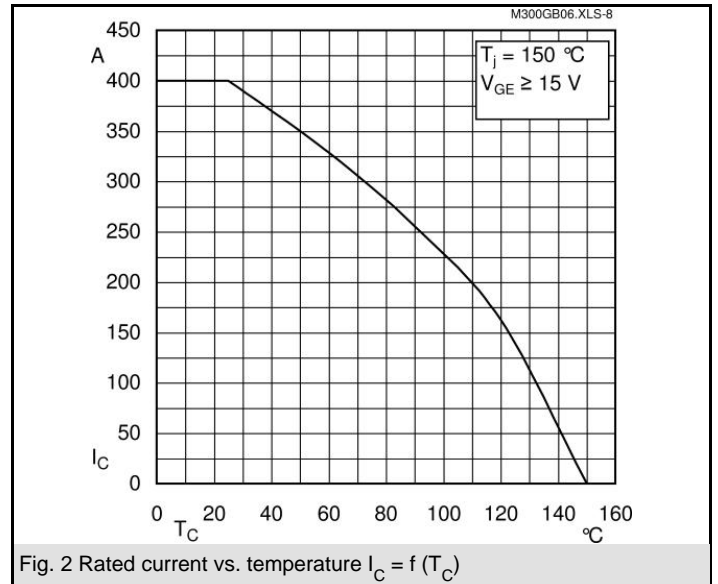
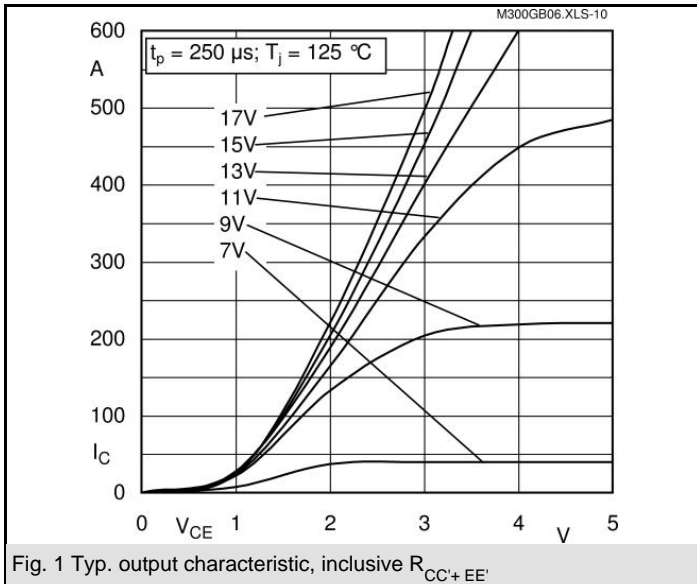

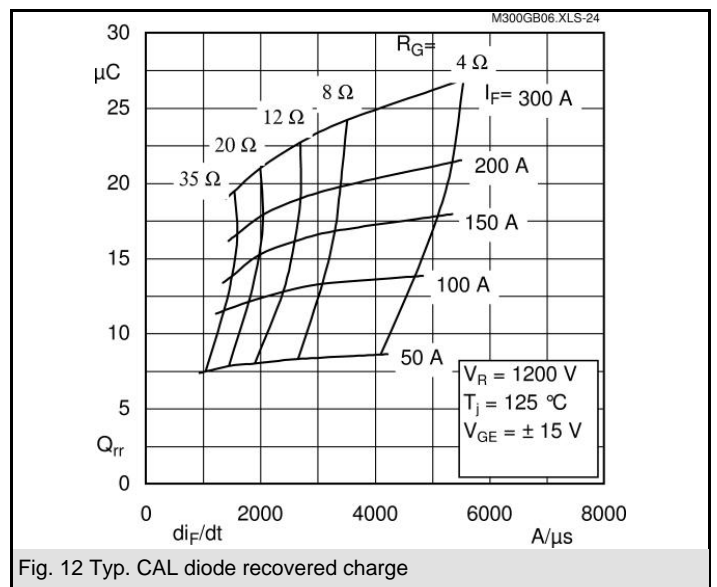
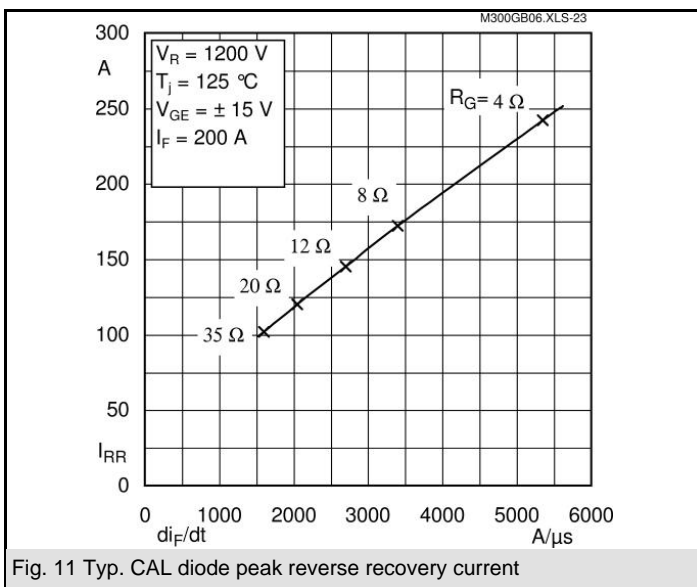
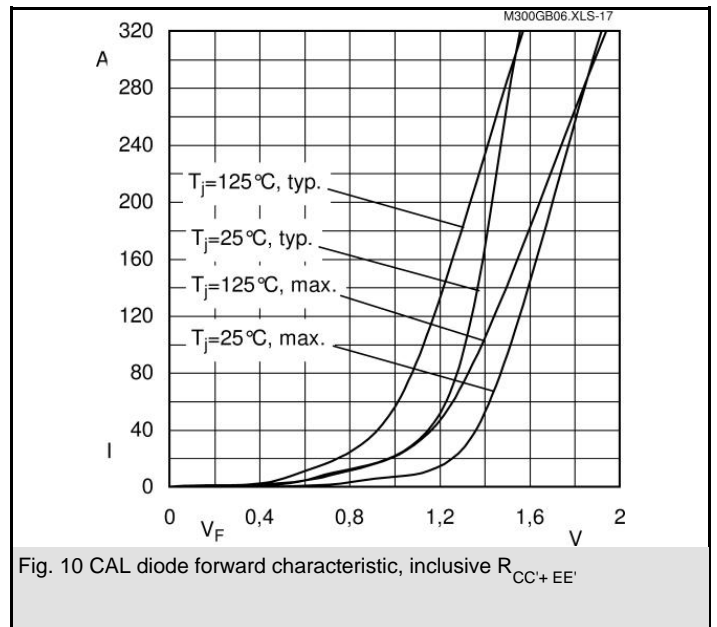
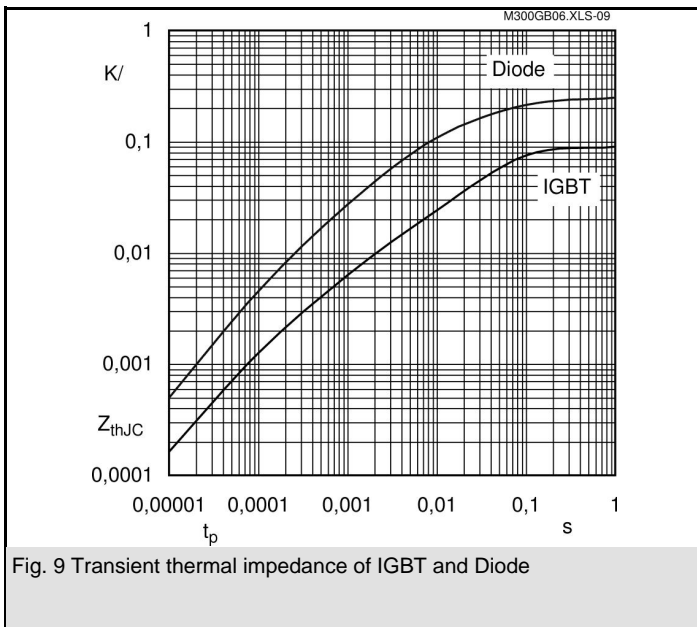
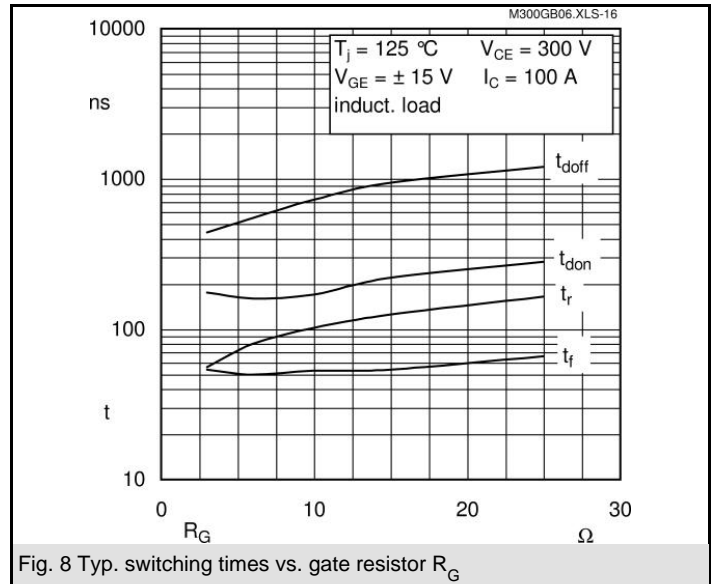
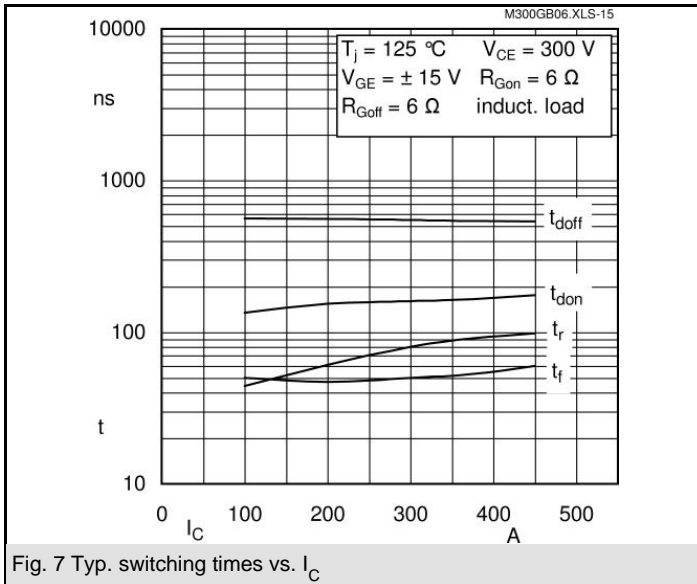

# SKM 300GB063D

UL Recognized

CASED56

File no. E 63 532

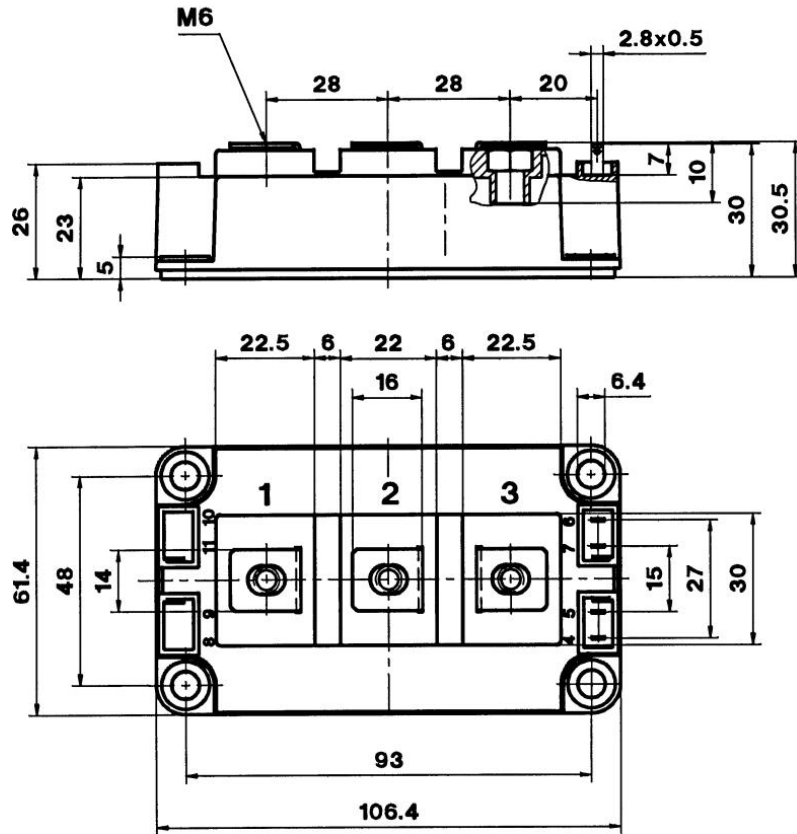

Case D 56

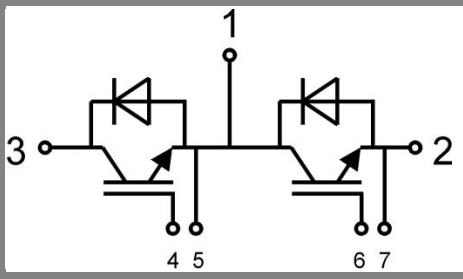

GB Case D 56

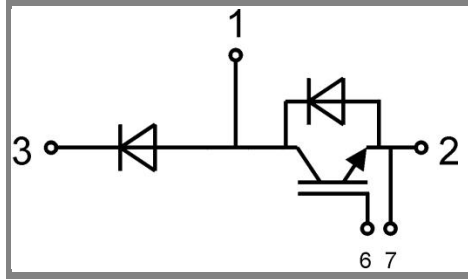

GAL Case D 57 (→ D 56)

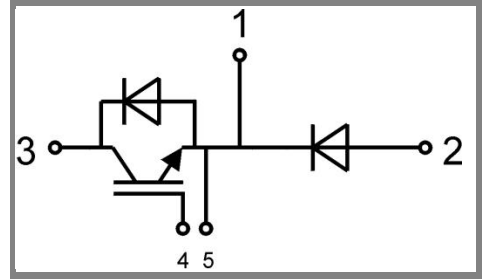

GAR Case D 58 (→ D 56)