

Absolute Maximum Ratings		Values	Units
Symbol	Conditions <sup>1)</sup>		
V <sub>CES</sub>		1200	V
V <sub>CGR</sub>	R <sub>GE</sub> = 20 kΩ	1200	V
I <sub>C</sub>	T <sub>case</sub> = 25/80 °C	570 / 400	A
I <sub>CM</sub>	T <sub>case</sub> = 25/80 °C; t <sub>p</sub> = 1 ms	1140 / 800	A
V <sub>GES</sub>		± 20	V
P <sub>tot</sub>	per IGBT, T <sub>case</sub> = 25 °C	2500	W
T <sub>j</sub> , (T <sub>stg</sub> )		-40 ... +150 (125)	°C
V <sub>isol</sub>	AC, 1 min.	2500	V
humidity	DIN 40040	Class F	
climate	DIN IEC 68 T.1	40/125/56	
Inverse Diode; Free-wheeling Diode FWD			
I <sub>F</sub> = -I <sub>C</sub>	T <sub>case</sub> = 25/80 °C	390 / 260	A
I <sub>FM</sub> = -I <sub>CM</sub>	T <sub>case</sub> = 25/80 °C; t <sub>p</sub> = 1 ms	1140 / 800	A
I <sub>FSM</sub>	t <sub>p</sub> = 10 ms; sin.; T <sub>j</sub> = 150 °C	2900	A
I <sup>2</sup> t	t <sub>p</sub> = 10 ms; T <sub>j</sub> = 150 °C	42 000	A <sup>2</sup> s

## SEMITRANS® M Low Loss IGBT Modules

**SKM 400 GB 124 D**  
**SKM 400 GAL 124D <sup>6)</sup>**  
**SKM 400 GAR 124D <sup>6)</sup>**



**SEMITRANS 3**

Characteristics		min.	typ.	max.	Units
Symbol	Conditions <sup>1)</sup>				
V <sub>(BR)CES</sub>	V <sub>GE</sub> = 0, I <sub>C</sub> = 4 mA	≥ V <sub>CES</sub>	-	-	V
V <sub>GE(th)</sub>	V <sub>GE</sub> = V <sub>CE</sub> , I <sub>C</sub> = 12 mA	4,5	5,5	6,5	V
I <sub>CES</sub>	V <sub>GE</sub> = 0 } T <sub>j</sub> = 25 °C V <sub>CE</sub> = V <sub>CES</sub> } T <sub>j</sub> = 125 °C	-	8	14	mA
I <sub>GES</sub>	V <sub>GE</sub> = 20 V, V <sub>CE</sub> = 0	-	-	0,35	μA
V <sub>CESat</sub>	I <sub>C</sub> = 300 A } V <sub>GE</sub> = 15 V; I <sub>C</sub> = 400 A } T <sub>j</sub> = 25 (125) °C	-	2,1(2,4)	2,45(2,85)	V
V <sub>CESat</sub>	I <sub>C</sub> = 400 A } T <sub>j</sub> = 25 (125) °C	-	2,5(3,0)	-	V
g <sub>fs</sub>	V <sub>CE</sub> = 20 V, I <sub>C</sub> = 300 A	110	-	-	S
C <sub>CHC</sub>	per IGBT	-	-	700	pF
C <sub>ies</sub>	V <sub>GE</sub> = 0	-	22	30	nF
C <sub>oes</sub>	V <sub>CE</sub> = 25 V	-	3,3	4	nF
C <sub>res</sub>	f = 1 MHz	-	1,2	1,6	nF
L <sub>CE</sub>		-	-	20	nH
t <sub>d(on)</sub>	V <sub>CC</sub> = 600 V	-	85	-	ns
t <sub>r</sub>	V <sub>GE</sub> = -15 V / +15 V <sup>3)</sup>	-	65	-	ns
t <sub>d(off)</sub>	I <sub>C</sub> = 300 A, ind. load	-	680	-	ns
t <sub>f</sub>	R <sub>Gon</sub> = R <sub>Goff</sub> = 5 Ω	-	56	-	ns
E <sub>on</sub>	T <sub>j</sub> = 125 °C	-	36	-	mWs
E <sub>off</sub>		-	42	-	mWs
Inverse Diode and FWD of types "GAL", "GAR" <sup>8)</sup>					
V <sub>F</sub> = V <sub>EC</sub>	I <sub>F</sub> = 300 A } V <sub>GE</sub> = 0 V; I <sub>F</sub> = 400 A } T <sub>j</sub> = 25 (125) °C	-	2,0(1,8)	2,5	V
V <sub>F</sub> = V <sub>EC</sub>	I <sub>F</sub> = 400 A } T <sub>j</sub> = 25 (125) °C	-	2,25(2,05)	-	V
V <sub>TO</sub>	T <sub>j</sub> = 125 °C <sup>2)</sup>	-	1,1	1,2	V
r <sub>t</sub>	T <sub>j</sub> = 125 °C <sup>2)</sup>	-	-	3,5	mΩ
I <sub>RRM</sub>	I <sub>F</sub> = 300 A; T <sub>j</sub> = 125 °C <sup>2)</sup>	-	136	-	A
Q <sub>rr</sub>	I <sub>F</sub> = 300 A; T <sub>j</sub> = 125 °C <sup>2)</sup>	-	36	-	μC
Thermal characteristics					
R <sub>thjc</sub>	per IGBT	-	-	0,05	°C/W
R <sub>thjc</sub>	per diode	-	-	0,125	°C/W
R <sub>thch</sub>	per module	-	-	0,038	°C/W

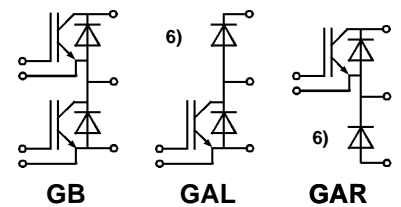

### Features

- MOS input (voltage controlled)
- N channel, homogeneous Silicon structure (NPT-Non punch through-IGBT)
- Low inductance case
- Very low tail current with low temperature dependence
- High short circuit capability, self limiting to 6 \* I<sub>Cnom</sub>
- Latch-up free
- Fast & soft inverse CAL diodes <sup>8)</sup>
- Isolated copper baseplate using DCB Direct Copper Bonding Technology without hard mould
- Large clearance (12 mm) and creepage distances (20 mm)

### Typical Applications → B 6 – 205

- Switching (not for linear use)
- Inverter drives
- UPS

<sup>1)</sup> T<sub>case</sub> = 25 °C, unless otherwise specified

<sup>2)</sup> I<sub>F</sub> = -I<sub>C</sub>, V<sub>R</sub> = 600 V, -di<sub>F</sub>/dt = 2000 A/μs, V<sub>GE</sub> = 0 V

<sup>3)</sup> Use V<sub>GEoff</sub> = -5... -15 V

<sup>6)</sup> The free-wheeling diodes of the GAL and GAR types have the data of the inverse diodes of SKM 400 GB 124 D

<sup>8)</sup> CAL = Controlled Axial Lifetime Technology.

### Cases and mech. data

→ B 6 – 206

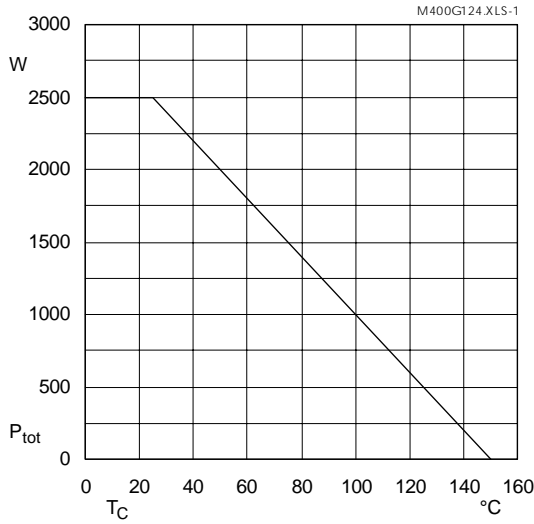

Fig. 1 Rated power dissipation  $P_{tot} = f(T_C)$

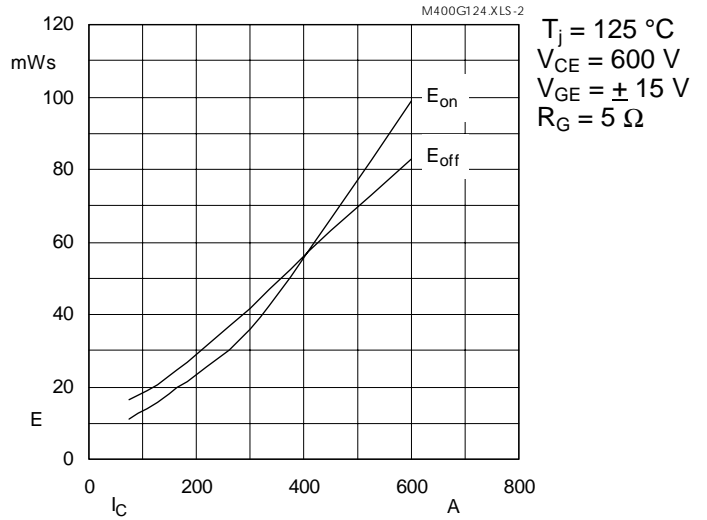

Fig. 2 Turn-on /-off energy  $E = f(I_C)$

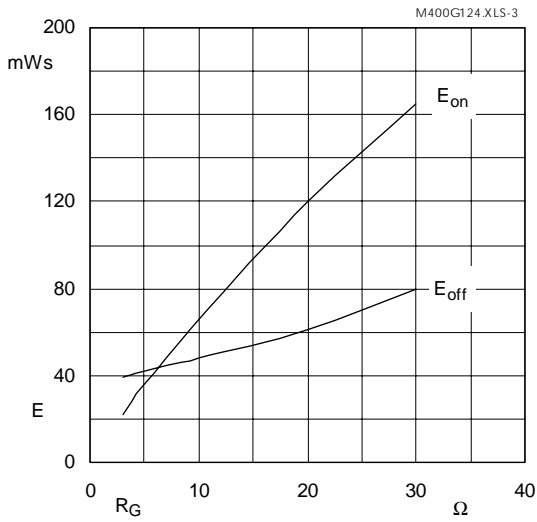

Fig. 3 Turn-on /-off energy  $E = f(R_G)$

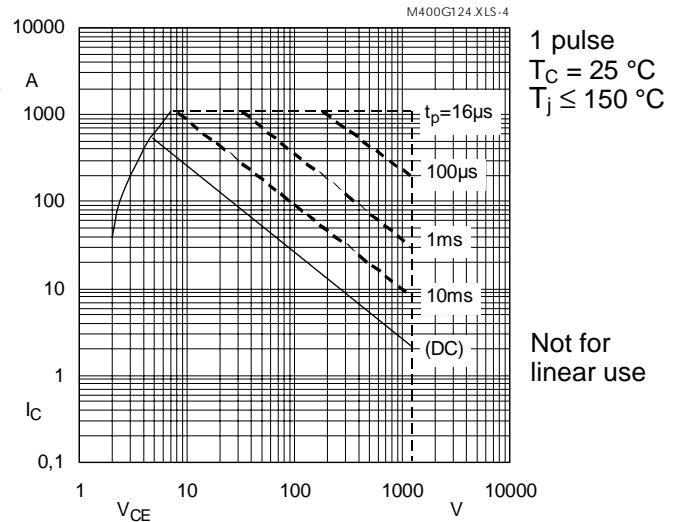

Fig. 4 Maximum safe operating area (SOA)  $I_C = f(V_{CE})$

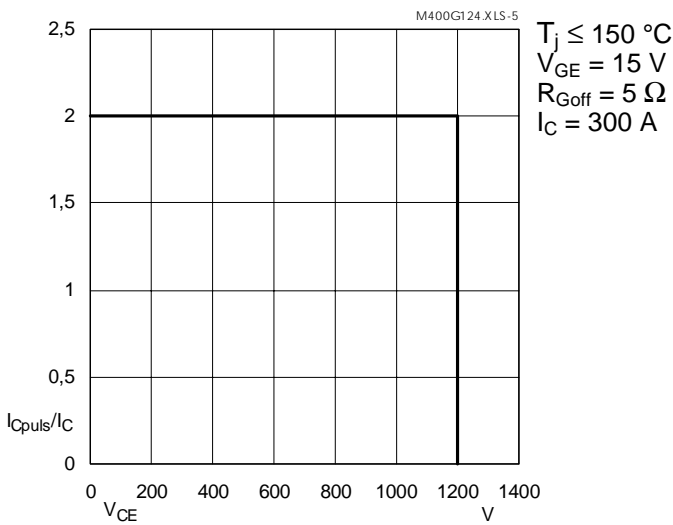

Fig. 5 Turn-off safe operating area (RBSOA)

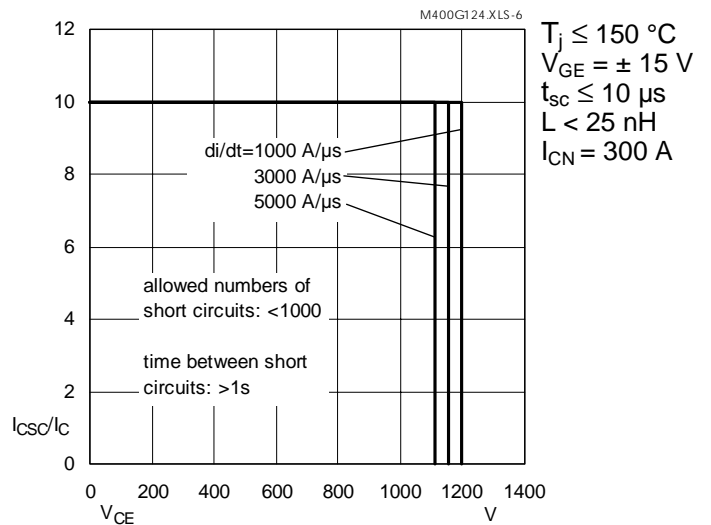

Fig. 6 Safe operating area at short circuit  $I_C = f(V_{CE})$

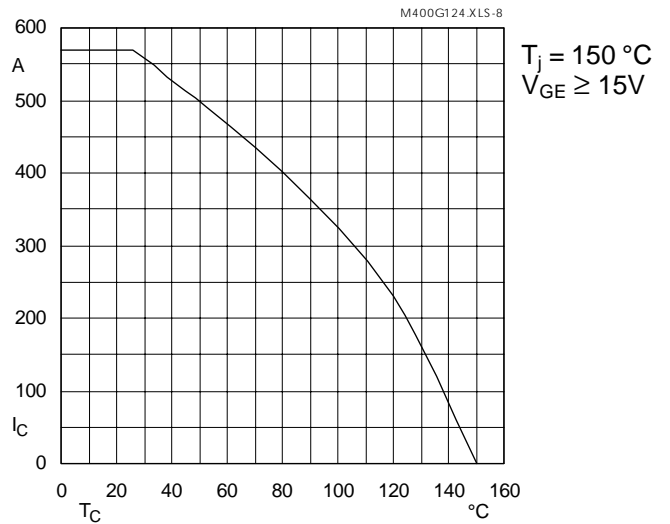

Fig. 8 Rated current vs. temperature  $I_C = f(T_C)$

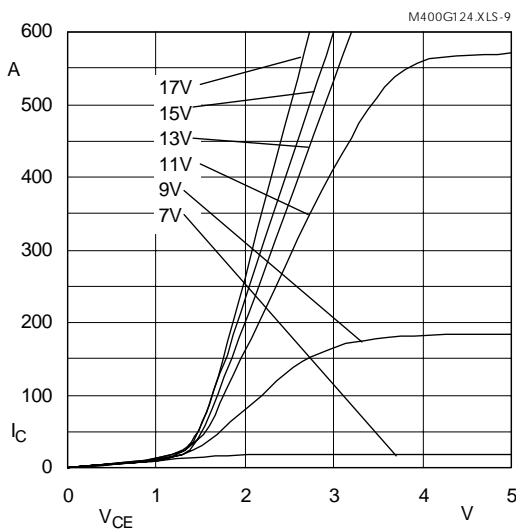

Fig. 9 Typ. output characteristic,  $t_p = 80\text{ }\mu\text{s}$ ;  $25\text{ }^\circ\text{C}$

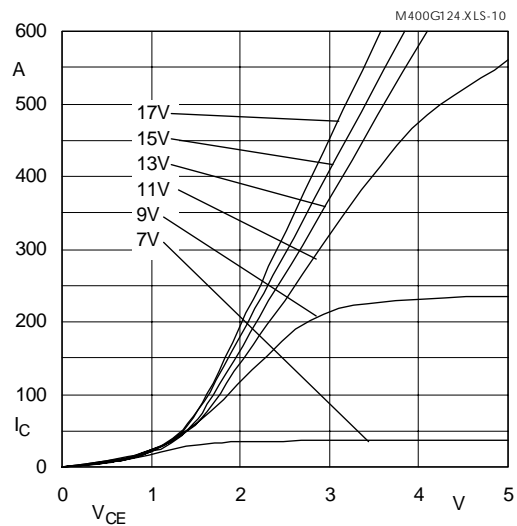

Fig. 10 Typ. output characteristic,  $t_p = 80\text{ }\mu\text{s}$ ;  $125\text{ }^\circ\text{C}$

$$P_{\text{cond}(t)} = V_{\text{CEsat}(t)} \cdot I_{\text{C}(t)}$$

$$V_{\text{CEsat}(t)} = V_{\text{CE(TO)(Tj)}} + r_{\text{CE(Tj)}} \cdot I_{\text{C}(t)}$$

$$V_{\text{CE(TO)(Tj)}} \leq 1,3 + 0,0005 (T_j - 25) \text{ [V]}$$

$$\text{typ.: } r_{\text{CE(Tj)}} = 0,0027 + 0,000008 (T_j - 25) \text{ [\Omega]}$$

$$\text{max.: } r_{\text{CE(Tj)}} = 0,0038 + 0,000012 (T_j - 25) \text{ [\Omega]}$$

$$\text{valid for } V_{\text{GE}} = +15_{-1}^{+2} \text{ [V]; } I_{\text{C}} > 0,3 I_{\text{Cnom}}$$

Fig. 11 Saturation characteristic (IGBT)  
Calculation elements and equations

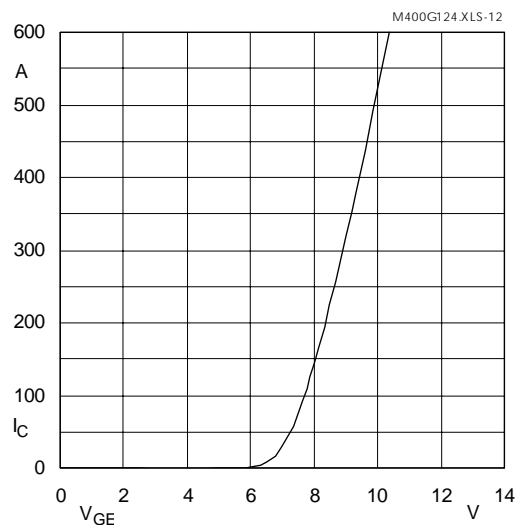

Fig. 12 Typ. transfer characteristic,  $t_p = 80\text{ }\mu\text{s}$ ;  $V_{CE} = 20\text{ V}$

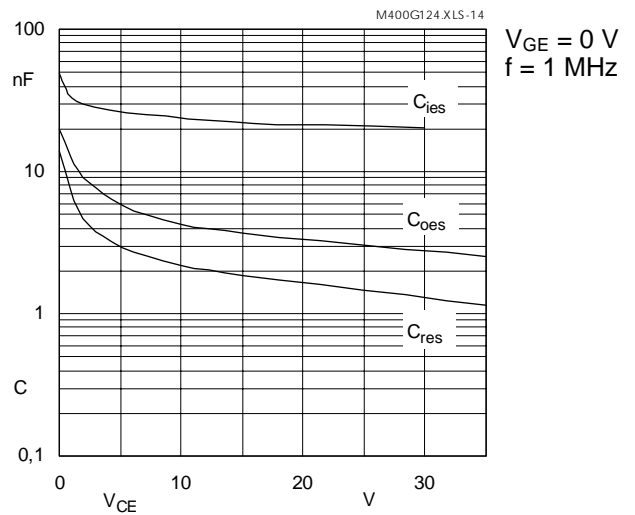
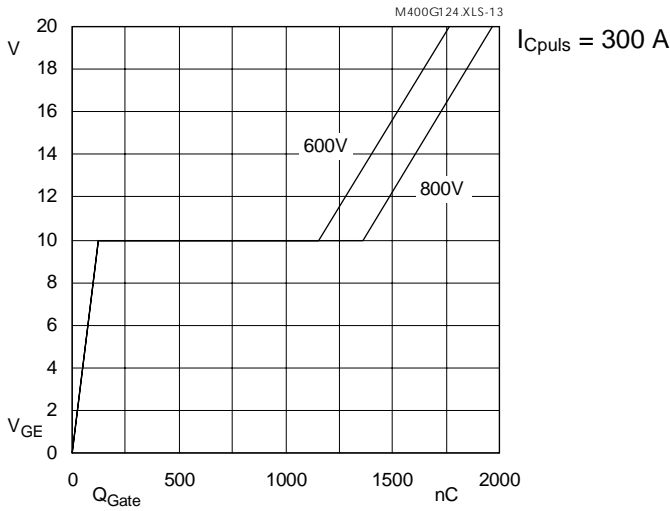

Fig. 13 Typ. gate charge characteristic

Fig. 14 Typ. capacitances vs.  $V_{CE}$

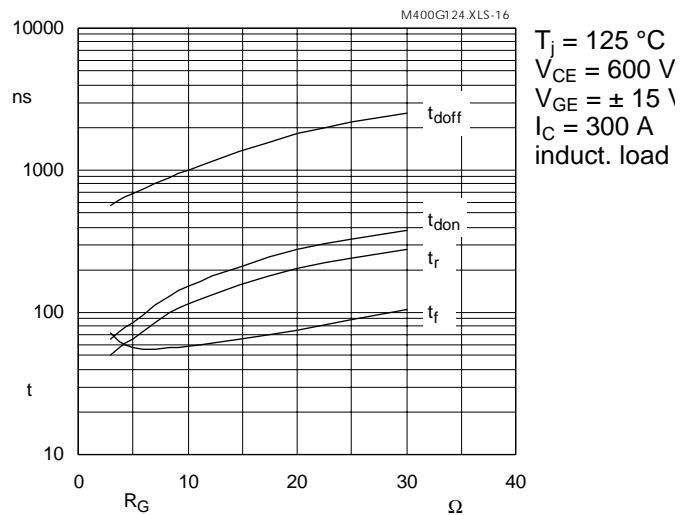
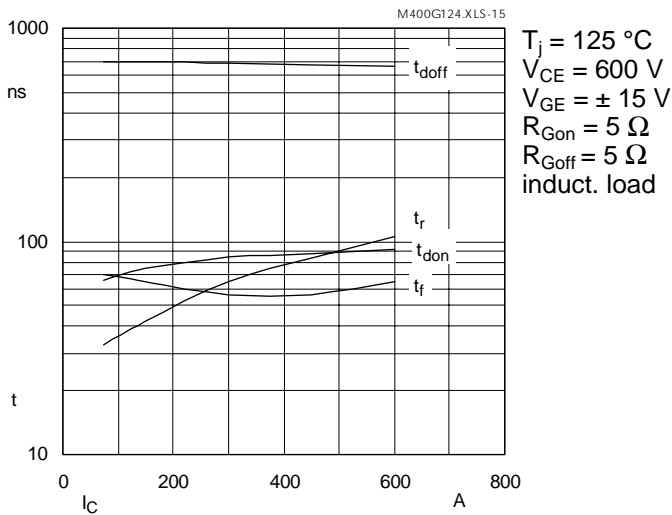

Fig. 15 Typ. switching times vs.  $I_C$

Fig. 16 Typ. switching times vs. gate resistor  $R_G$

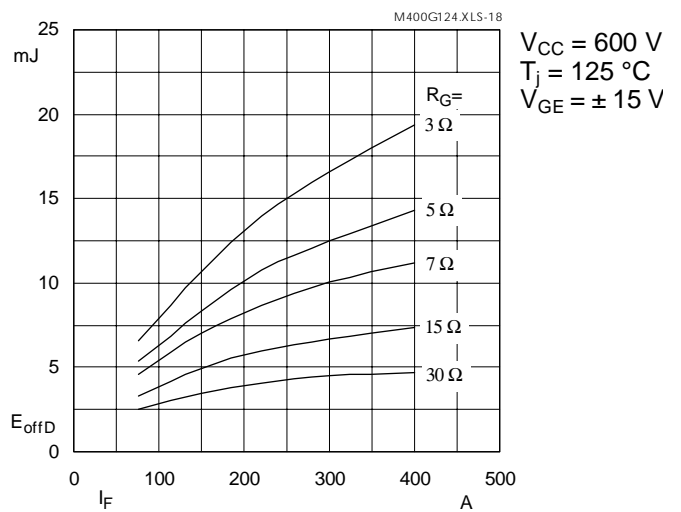
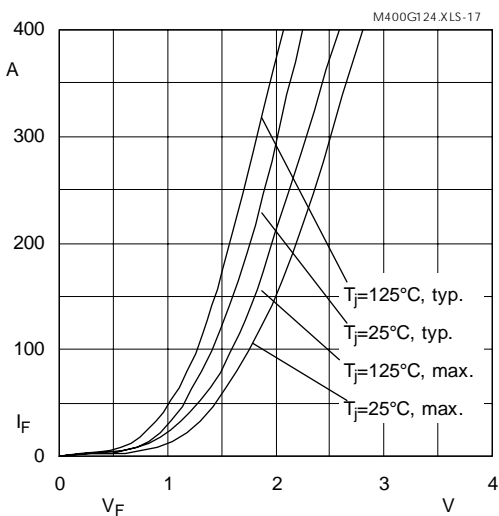

Fig. 17 Typ. CAL diode forward characteristic

Fig. 18 Diode turn-off energy dissipation per pulse

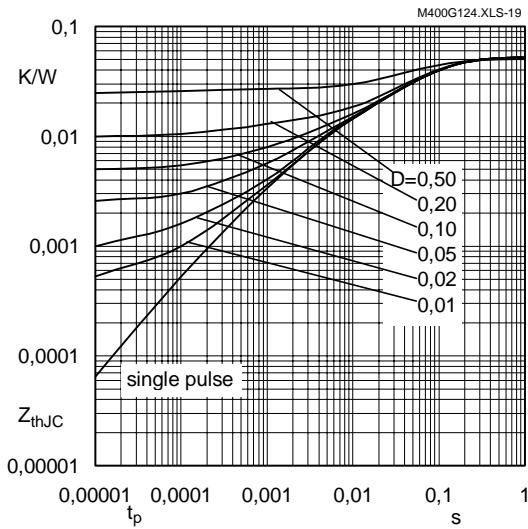

Fig. 19 Transient thermal impedance of IGBT  
 $Z_{thJC} = f(t_p)$ ;  $D = t_p / t_c = t_p \cdot f$

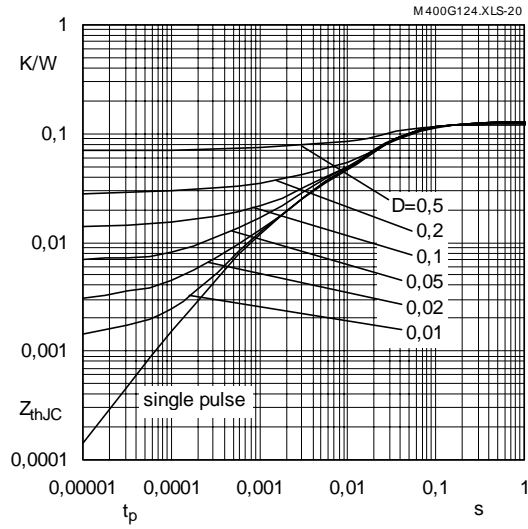

Fig. 20 Transient thermal impedance of inverse CAL diodes  
 $Z_{thJC} = f(t_p)$ ;  $D = t_p / t_c = t_p \cdot f$

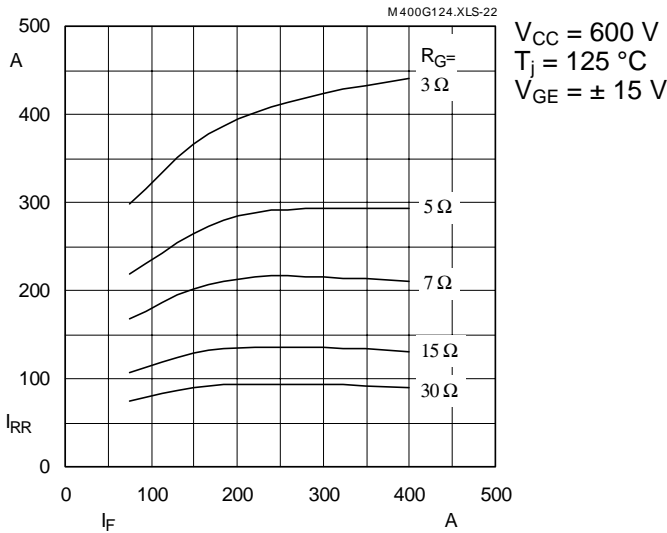

Fig. 22 Typ. CAL diode peak reverse recovery current  $I_{RR} = f(I_F; R_G)$

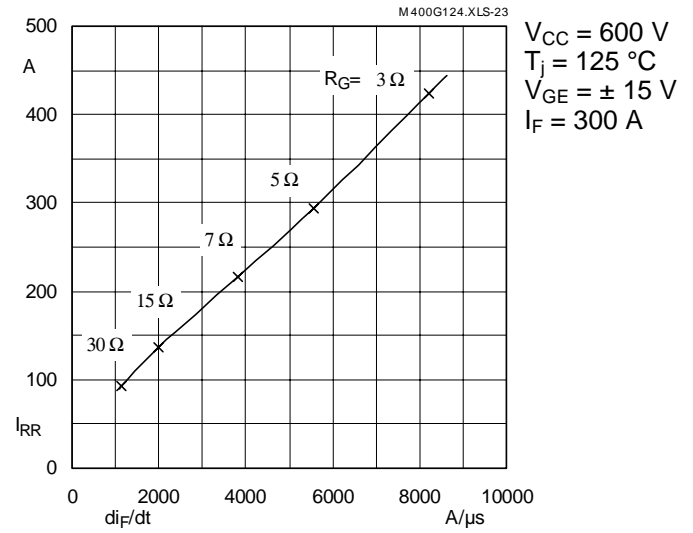

Fig. 23 Typ. CAL diode peak reverse recovery current  $I_{RR} = f(di/dt)$

## Typical Applications

### include

- Switched mode power supplies
- DC servo and robot drives
- Inverters
- DC choppers
- AC motor speed control
- UPS Uninterruptable power supplies
- General power switching applications
- Electronic (also portable) welders

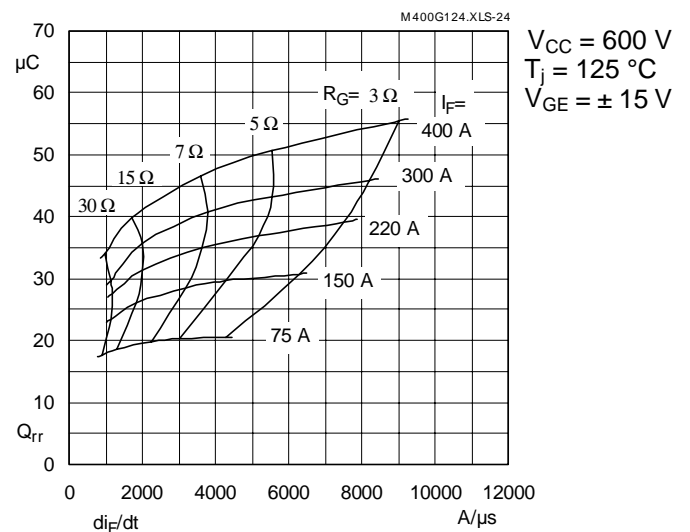
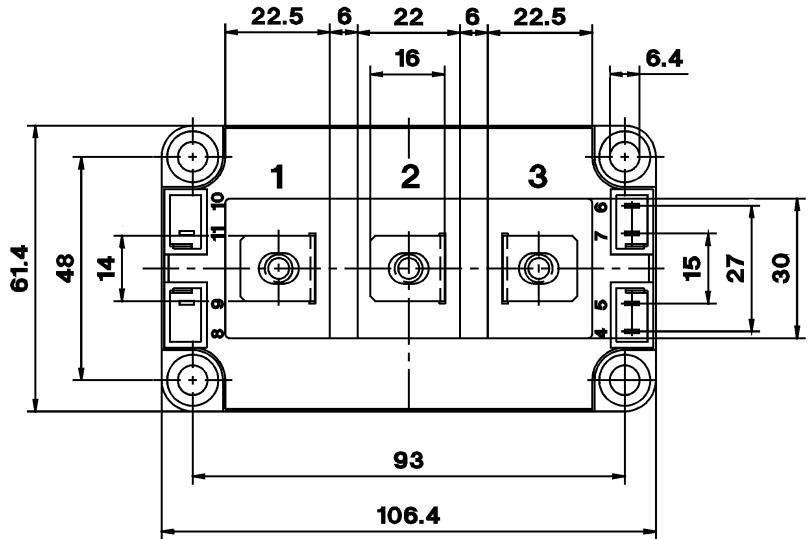
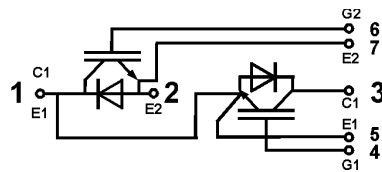
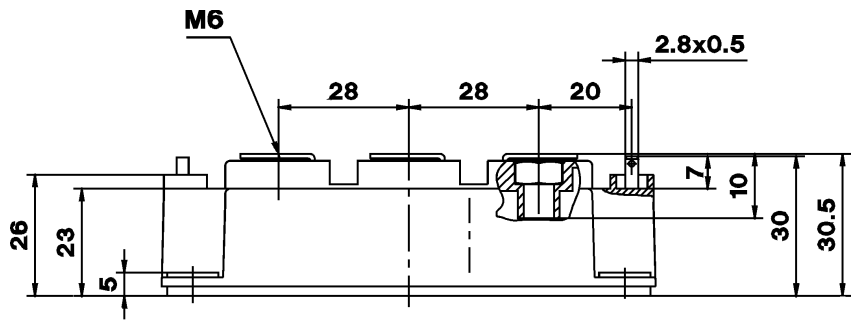

Fig. 24 Typ. CAL diode recovered charge

**SEMITRANS 3**

Case D 56  
 UL Recognized  
 File no. E 63 532

**SKM 400 GB 124 D**



Dimensions in mm

**SKM 400 GAL 124 D**

Case D 57 ( → D 56)

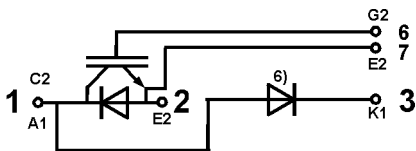

**SKM 400 GAR 124 D**

Case D 58 ( → D 56)

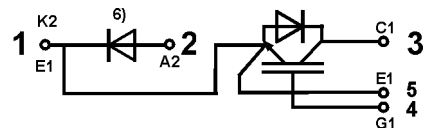

Case outline and circuit diagrams

Mechanical Data			Values			Units
Symbol	Conditions		min.	typ.	max.	
M <sub>1</sub>	to heatsink, SI Units	(M6)	3	-	5	Nm
	to heatsink, US Units		27	-	44	lb.in.
M <sub>2</sub>	for terminals, SI Units	(M6)	2,5	-	5	Nm
	for terminals, US Units		22	-	44	lb.in.
a			-	-	5x9,81	m/s <sup>2</sup>
w			-	-	325	g

<sup>6)</sup> Freewheeling diode → B 6 – 201, remark 6.

This is an electrostatic discharge sensitive device (ESDS). Please observe the international standard IEC 747-1, Chapter IX.

Three devices are supplied in one SEMIBOX A without mounting hardware, which can be ordered separately under Ident No. 33321100 (for 10 SEMITRANS 3). Larger packing units of 12 and 20 pieces are used if suitable  
 Accessories → B 6 – 4.  
 SEMIBOX → C – 1.