

SKM 400GB066D



SEMITRANS® 3

Trench IGBT Modules

SKM 400GB066D

Features

- Trench = Trenchgate technology
- $V_{CE(sat)}$ with positive temperature coefficient
- High short circuit capability, self limiting to $6 \times I_C$

Typical Applications*

- AC inverter drives
- UPS
- Electronic welders

Remarks

- Case temperature limited to $T_C = 125^\circ\text{C}$ max, recommended $T_{op} = -40 \dots +150^\circ\text{C}$
- Product reliability results are valid for $T_j \leq 150^\circ\text{C}$
- Short circuit data: $t_p \leq 6\mu\text{s}$; $V_{GE} \leq 15\text{V}$; $T_j = 150^\circ\text{C}$; $V_{CC} \leq 360\text{V}$, use of soft R_G necessary !
- Take care of over-voltage caused by stray inductances

Absolute Maximum Ratings		$T_{case} = 25^\circ\text{C}$, unless otherwise specified			
Symbol	Conditions	Values			Units
IGBT					
V_{CES}	$T_j = 25^\circ\text{C}$	600			V
I_C	$T_j = 175^\circ\text{C}$	$T_c = 25^\circ\text{C}$	500		A
		$T_c = 80^\circ\text{C}$	380		A
I_{CRM}	$I_{CRM} = 2 \times I_{Cnom}$	800			A
V_{GES}		± 20			V
t_{psc}	$V_{CC} = 360\text{V}$; $V_{GE} \leq 15\text{V}$; $T_j = 150^\circ\text{C}$ $V_{CES} < 600\text{V}$	6			μs
Inverse Diode					
I_F	$T_j = 175^\circ\text{C}$	$T_c = 25^\circ\text{C}$	450		A
		$T_c = 80^\circ\text{C}$	320		A
I_{FRM}	$I_{FRM} = 2 \times I_{Fnom}$	800			A
Module					
$I_{t(RMS)}$		500			A
T_{vj}		- 40 ... +175			$^\circ\text{C}$
T_{stg}		- 40 ... +125			$^\circ\text{C}$
V_{isol}	AC, 1 min.	4000			V

Characteristics		$T_{case} = 25^\circ\text{C}$, unless otherwise specified			
Symbol	Conditions	min.	typ.	max.	Units
IGBT					
$V_{GE(th)}$	$V_{GE} = V_{CE}$, $I_C = 6,4\text{mA}$	5	5,8	6,5	V
I_{CES}	$V_{GE} = 0\text{V}$, $V_{CE} = V_{CES}$		0,25	0,75	mA
V_{CE0}		$T_j = 25^\circ\text{C}$	0,9	1	V
		$T_j = 150^\circ\text{C}$	0,85	0,9	V
r_{CE}	$V_{GE} = 15\text{V}$	$T_j = 25^\circ\text{C}$	1,4	2,3	$\text{m}\Omega$
		$T_j = 150^\circ\text{C}$	2,1	3	$\text{m}\Omega$
$V_{CE(sat)}$	$I_{Cnom} = 400\text{A}$, $V_{GE} = 15\text{V}$	$T_j = 25^\circ\text{C}_{chiplev.}$	1,45	1,9	V
		$T_j = 150^\circ\text{C}_{chiplev.}$	1,7	2,1	V
C_{ies}	$V_{CE} = 25$, $V_{GE} = 0\text{V}$	$f = 1\text{MHz}$	24,7		nF
C_{oes}			1,54		nF
C_{res}			0,73		nF
Q_G	$V_{GE} = -8\text{V} \dots +15\text{V}$	3000			nC
R_{Gint}	$T_j = ^\circ\text{C}$	2			Ω
$t_{d(on)}$	$R_{Gon} = 1,5\Omega$	$V_{CC} = 300\text{V}$ $I_C = 400\text{A}$	200		ns
t_r			60		ns
E_{on}	$R_{Goff} = 1,5\Omega$	$T_j = 150^\circ\text{C}$ $V_{GE} = -8\text{V}/+15\text{V}$	8		mJ
$t_{d(off)}$			560		ns
t_f			53		ns
E_{off}			16		mJ
$R_{th(j-c)}$	per IGBT	0,12			K/W

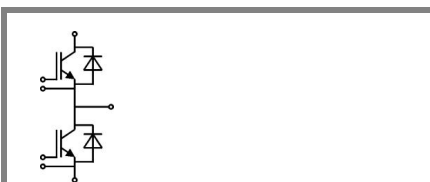

GB

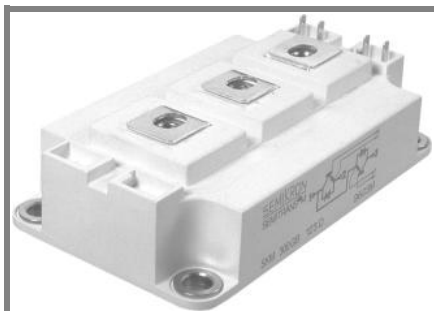

SEMITRANS® 3

Trench IGBT Modules

SKM 400GB066D

Features

- Trench = Trenchgate technology
- $V_{CE(sat)}$ with positive temperature coefficient
- High short circuit capability, self limiting to $6 \times I_C$

Typical Applications*

- AC inverter drives
- UPS
- Electronic welders

Remarks

- Case temperature limited to $T_C = 125^\circ\text{C}$ max, recommended $T_{op} = -40 \dots +150^\circ\text{C}$
- Product reliability results are valid for $T_j \leq 150^\circ\text{C}$
- Short circuit data: $t_p \leq 6\mu\text{s}$; $V_{GE} \leq 15\text{V}$; $T_j = 150^\circ\text{C}$; $V_{CC} \leq 360\text{V}$, use of soft R_G necessary !
- Take care of over-voltage caused by stray inductances

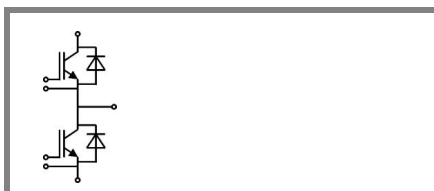

GB

Characteristics

Symbol	Conditions	min.	typ.	max.	Units
Inverse Diode					
$V_F = V_{EC}$	$I_{Fnom} = 400\text{ A}$; $V_{GE} = 0\text{ V}$ $T_j = 25^\circ\text{C}_{chiplev.}$		1,4	1,6	V
V_{F0}	$T_j = 25^\circ\text{C}$		0,95	1	V
r_F	$T_j = 25^\circ\text{C}$		1,1	1,5	mΩ
I_{RRM}	$I_F = 400\text{ A}$ $T_j = 150^\circ\text{C}$		410		A
Q_{rr}	$di/dt = 7250\text{ A}/\mu\text{s}$		62		μC
E_{rr}	$V_{GE} = -8\text{ V}$; $V_{CC} = 300\text{ V}$		14		mJ
$R_{th(j-c)D}$	per diode			0,2	K/W
Module					
L_{CE}			15	20	nH
R_{CC+EE}	res., terminal-chip $T_{case} = 25^\circ\text{C}$		0,35		mΩ
	$T_{case} = 125^\circ\text{C}$		0,5		mΩ
$R_{th(c-s)}$	per module			0,038	K/W
M_s	to heat sink M6	3		5	Nm
M_t	to terminals M6	2,5		5	Nm
w				325	g

This is an electrostatic discharge sensitive device (ESDS), international standard IEC 60747-1, Chapter IX.

* The specifications of our components may not be considered as an assurance of component characteristics. Components have to be tested for the respective application. Adjustments may be necessary. The use of SEMIKRON products in life support appliances and systems is subject to prior specification and written approval by SEMIKRON. We therefore strongly recommend prior consultation of our personal.

SKM 400GB066D



SEMITRANS® 3

Trench IGBT Modules

SKM 400GB066D

Features

- Trench = Trenchgate technology
- $V_{CE(sat)}$ with positive temperature coefficient
- High short circuit capability, self limiting to $6 \times I_C$

Typical Applications*

- AC inverter drives
- UPS
- Electronic welders

Remarks

- Case temperature limited to $T_C = 125^\circ\text{C}$ max, recommended $T_{op} = -40 \dots +150^\circ\text{C}$
- Product reliability results are valid for $T_j \leq 150^\circ\text{C}$
- Short circuit data: $t_p \leq 6\mu\text{s}$; $V_{GE} \leq 15\text{V}$; $T_j = 150^\circ\text{C}$; $V_{cc} \leq 360\text{V}$, use of soft R_G necessary !
- Take care of over-voltage caused by stray inductances

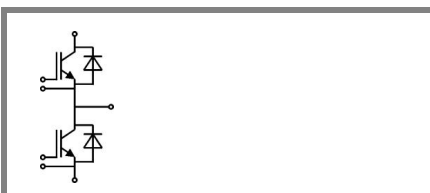

GB

Z_{th}		Values	Units
Symbol	Conditions		
$Z_{th(j-c)I}$			
$R_{\theta j-c}$	$i = 1$	80	mk/W
$R_{\theta j-c}$	$i = 2$	22,5	mk/W
$R_{\theta j-c}$	$i = 3$	6,4	mk/W
$R_{\theta j-c}$	$i = 4$	1,1	mk/W
$\tau_{th j-c}$	$i = 1$	0,0447	s
$\tau_{th j-c}$	$i = 2$	0,0223	s
$\tau_{th j-c}$	$i = 3$	0,0015	s
$\tau_{th j-c}$	$i = 4$	0,0002	s
$Z_{th(j-c)D}$			
$R_{\theta j-c}$	$i = 1$	130	mk/W
$R_{\theta j-c}$	$i = 2$	55	mk/W
$R_{\theta j-c}$	$i = 3$	12,5	mk/W
$R_{\theta j-c}$	$i = 4$	2,5	mk/W
$\tau_{th j-c}$	$i = 1$	0,054	s
$\tau_{th j-c}$	$i = 2$	0,01	s
$\tau_{th j-c}$	$i = 3$	0,0015	s
$\tau_{th j-c}$	$i = 4$	0,1	s

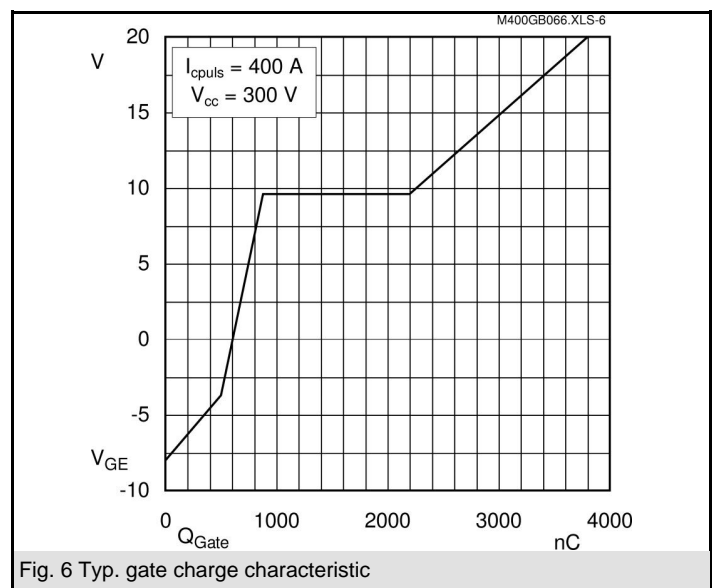
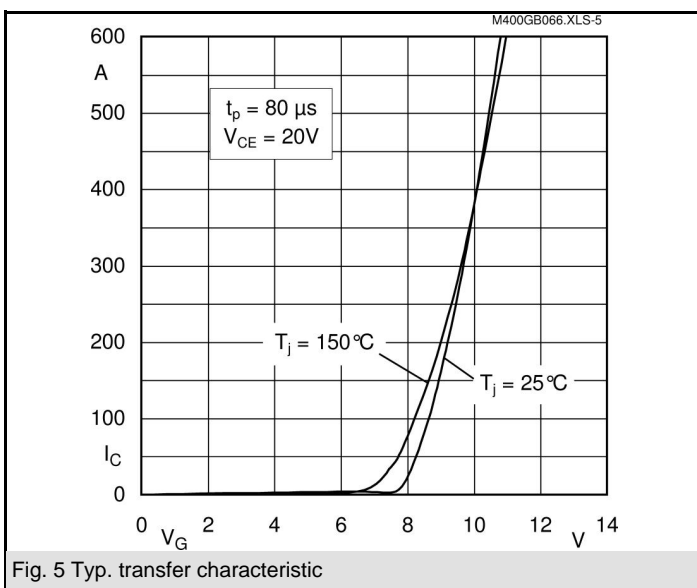
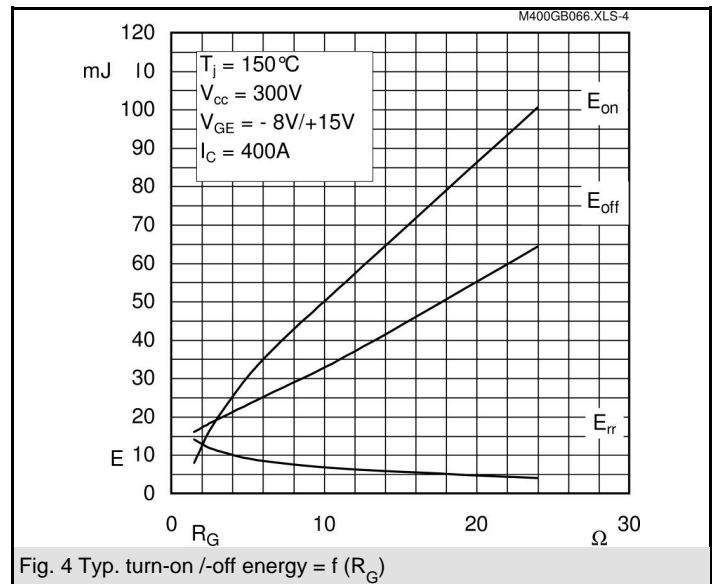
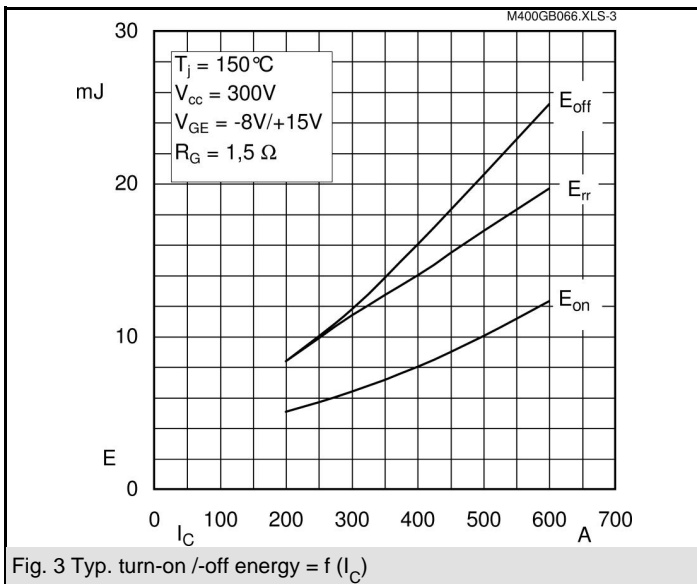
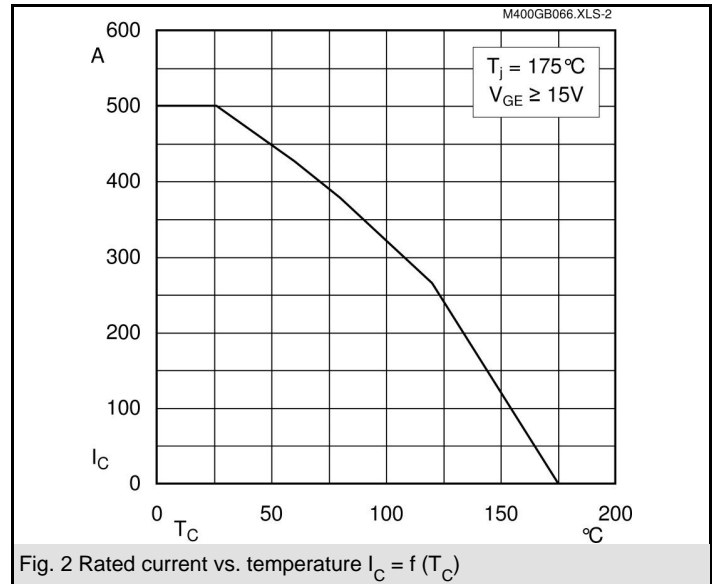
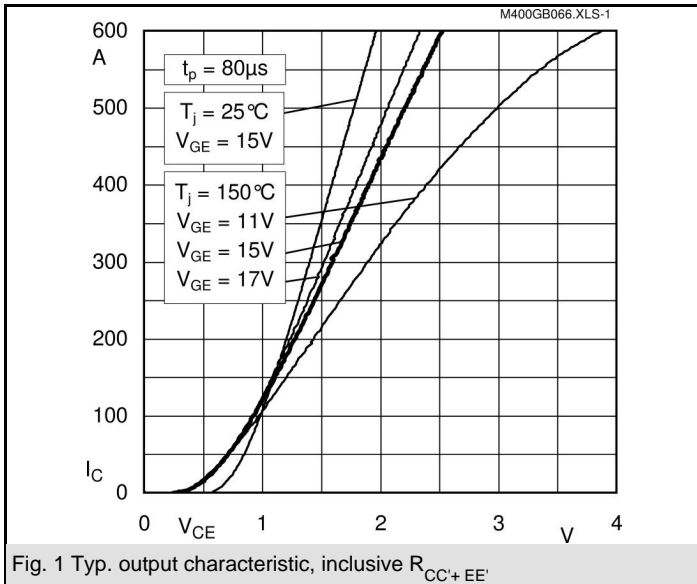

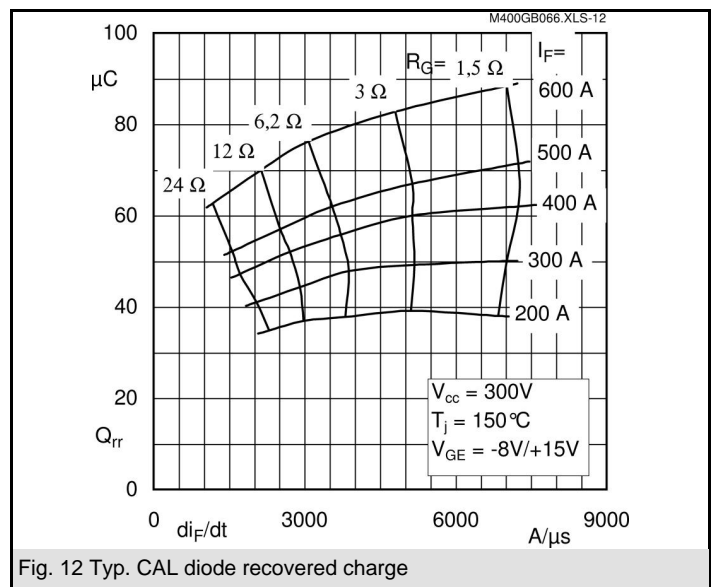
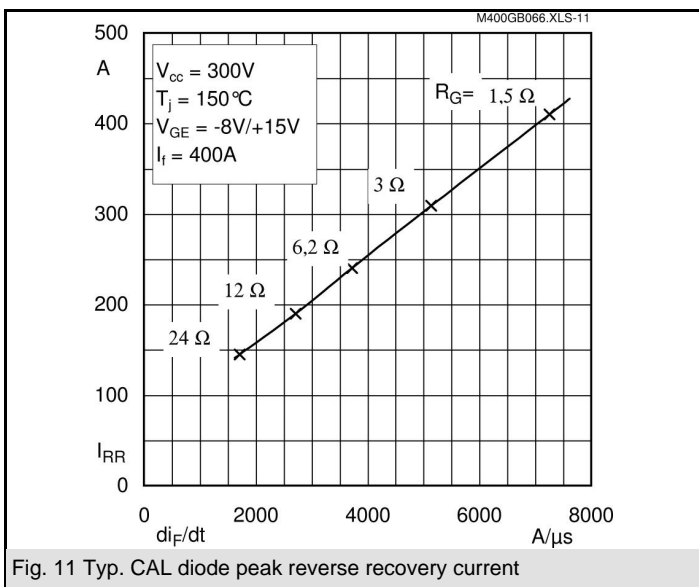
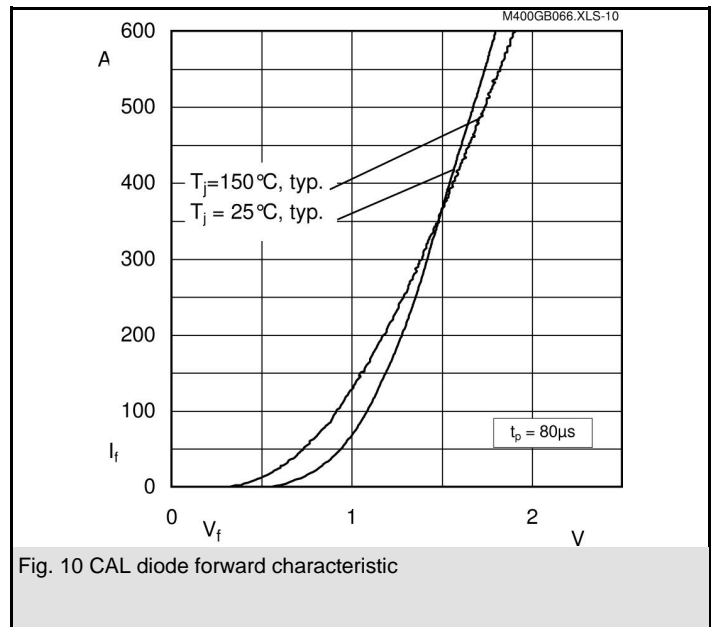
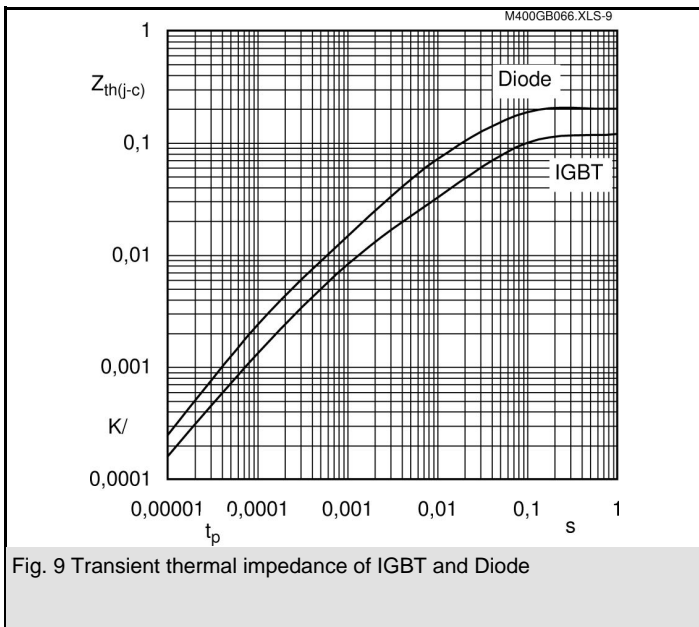
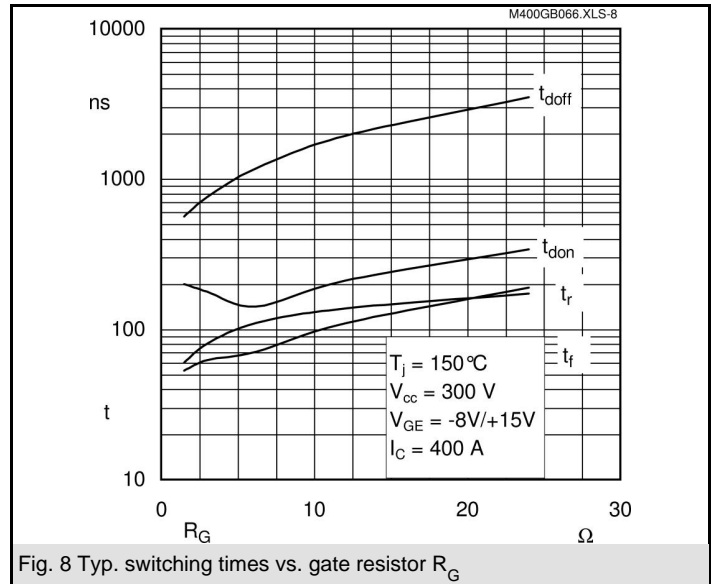
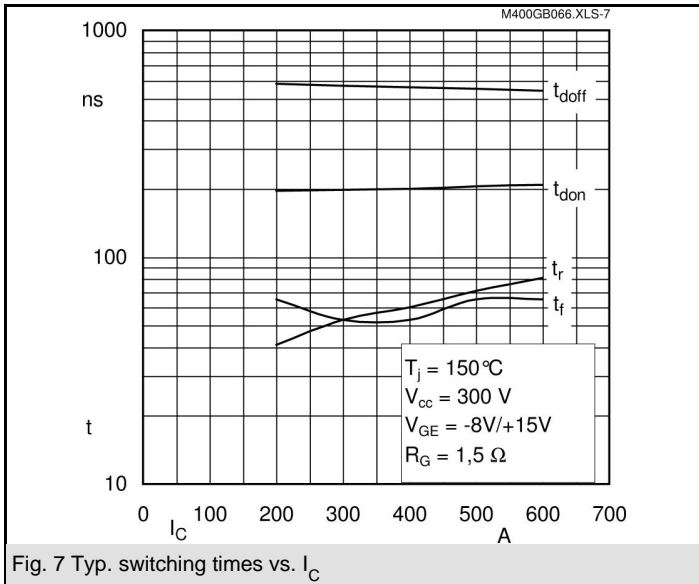

SKM 400GB066D

UL recognized, file no. E 63 532

CASED56

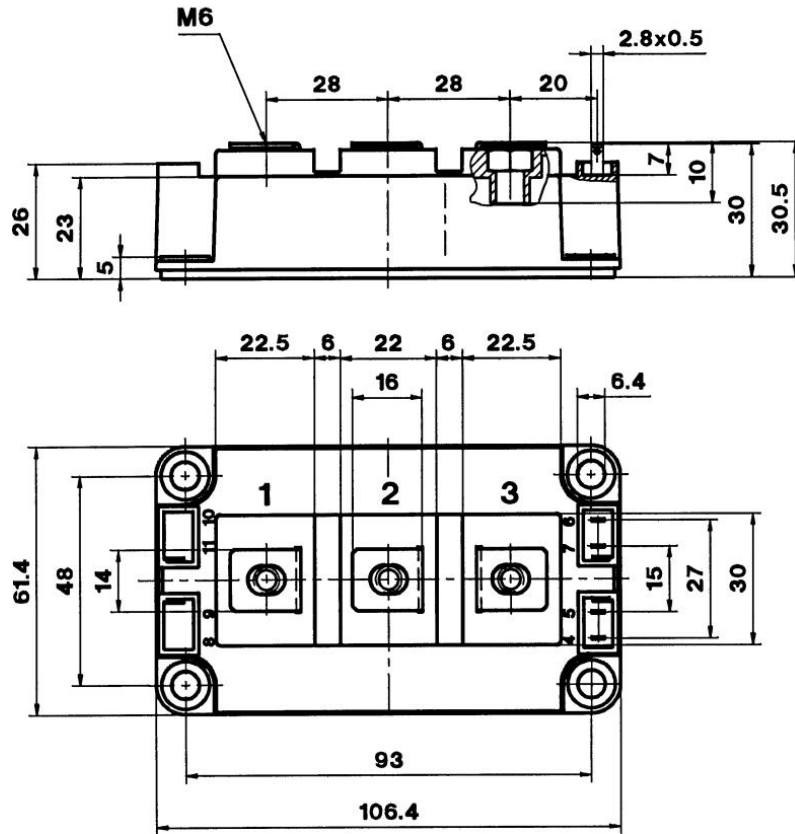

Case D 56

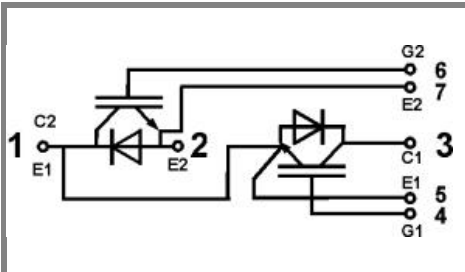

GB

Case D56