

SKKD 100, SKMD 100



SEMIPACK[®] 1

Rectifier Diode Modules

SKKD 100

SKMD 100

Features

- Heat transfer through aluminium oxide ceramic isolated metal baseplate
- Hard soldered joints for high reliability
- SKKD half bridge connection
center-tap connections
- SKMD common cathode
- UL recognized, file no. E 63 532

Typical Applications

- Non-controllable rectifiers for AC/AC converters
- Line rectifiers for transistorized AC motor controllers
- Field supply for DC motors

V_{RSM} V	V_{RRM} V	$I_{FRMS} = 175$ A (maximum value for continuous operation) $I_{FAV} = 100$ A (sin. 180; $T_c = 85$ °C)	
500	400	SKKD 100/04	SKMD 100/04
900	800	SKKD 100/08	SKMD 100/08
1300	1200	SKKD 100/12	
1500	1400	SKKD 100/14	SKMD 100/14
1700	1600	SKKD 100/16	SKMD 100/16
1900	1800	SKKD 100/18	

Symbol	Conditions	Values	Units
I_{FAV}	sin. 180; $T_c = 85$ (100) °C	100 (67)	A
I_D	P3/180; $T_a = 45$ °C; B2 / B6	73 / 91	A
	P3/180F; $T_a = 35$ °C; B2 / B6	150 / 190	A
I_{FSM}	$T_{vj} = 25$ °C; 10 ms	2500	A
	$T_{vj} = 125$ °C; 10 ms	2000	A
i^2t	$T_{vj} = 25$ °C; 8,3 ... 10 ms	31250	A ² s
	$T_{vj} = 125$ °C; 8,3 ... 10 ms	20000	A ² s
V_F	$T_{vj} = 25$ °C; $I_F = 300$ A	max. 1,35	V
$V_{(TO)}$	$T_{vj} = 125$ °C	0,85	V
r_T	$T_{vj} = 125$ °C	1,3	mΩ
I_{RD}	$T_{vj} = 125$ °C; $V_{RD} = V_{RRM}$	max. 5	mA
$R_{th(j-c)}$	per diode / per module	0,35 / 0,175	K/W
$R_{th(c-s)}$	per diode / per module	0,2 / 0,1	K/W
T_{vj}		- 40 ... + 125	°C
T_{stg}		- 40 ... + 125	°C
V_{isol}	a. c. 50 Hz; r.m.s.; 1 s / 1 min.	3600 / 3000	V~
M_s	to heatsink	5 ± 15 %	Nm
M_t	to terminals	3 ± 15 %	Nm
a		5 * 9,81	m/s ²
m	approx.	95	g
Case	SKKD	A 10	
	SKMD	A 33	

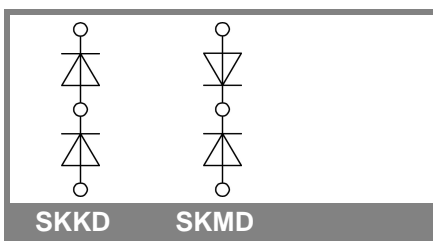

SKKD 100, SKMD 100

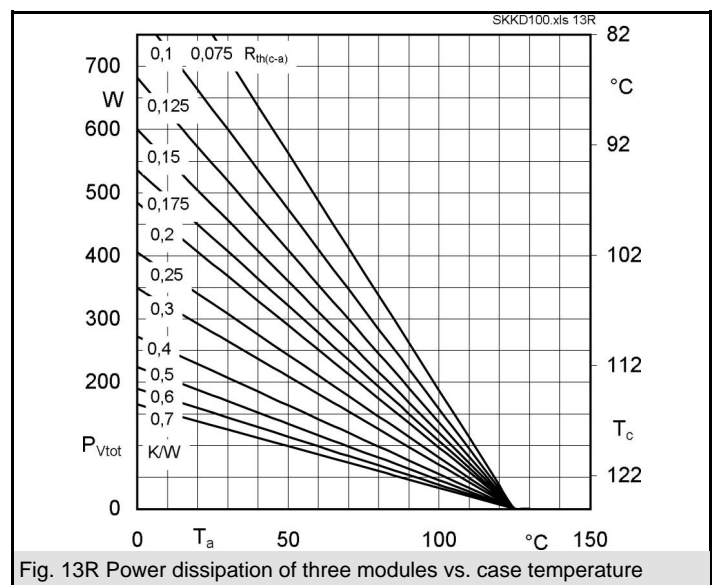
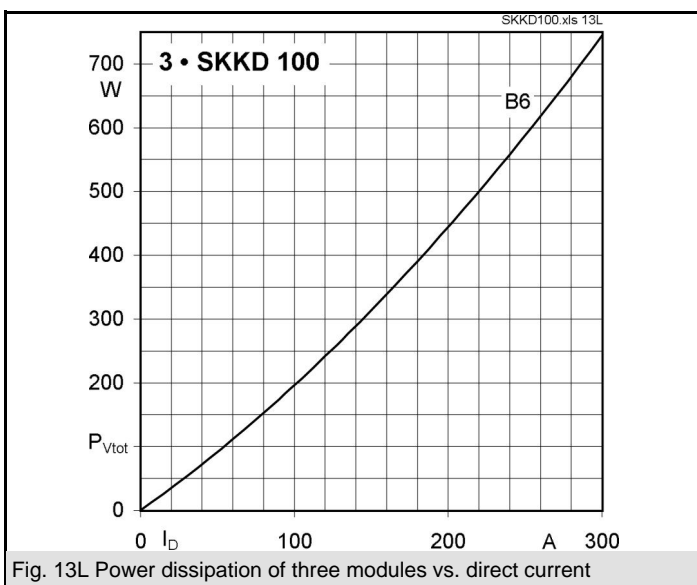
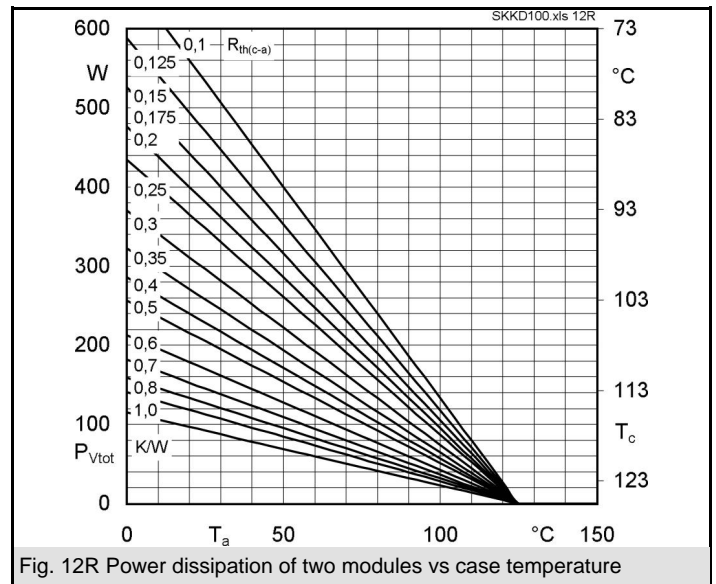
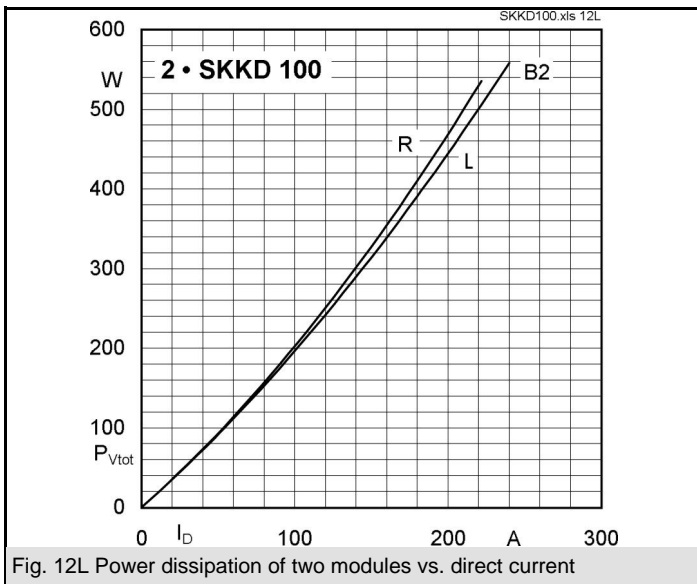
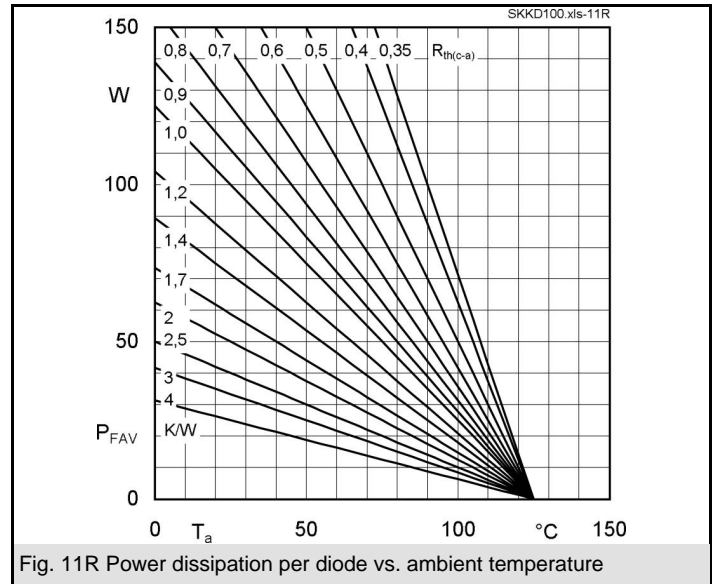
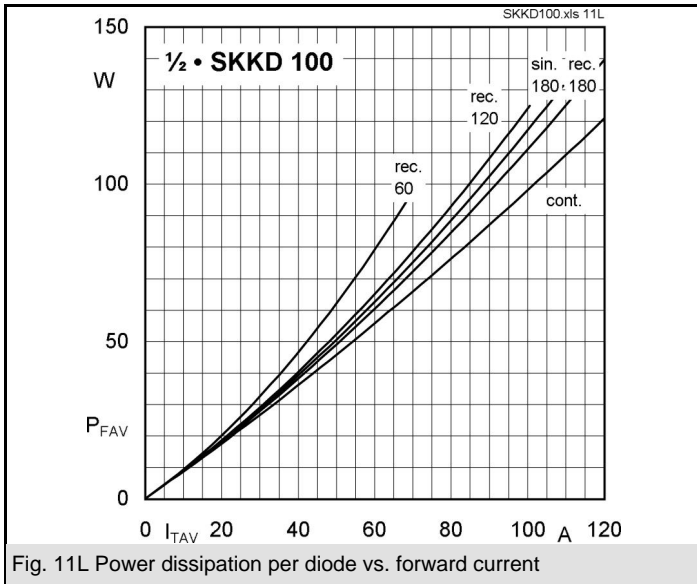

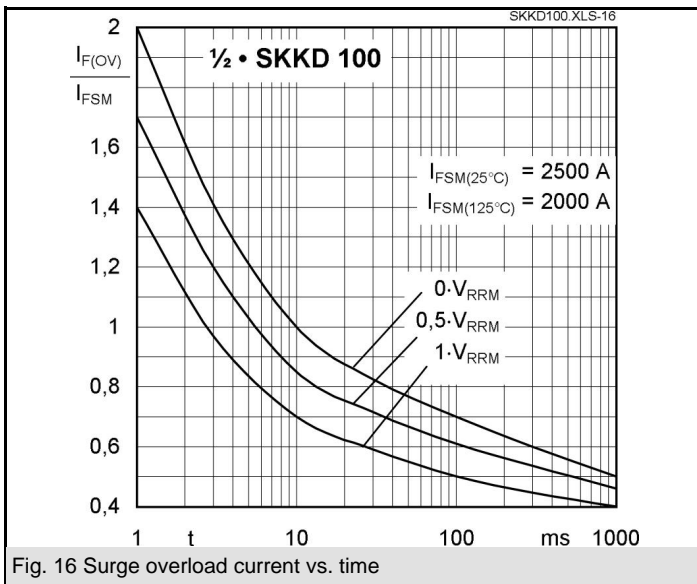
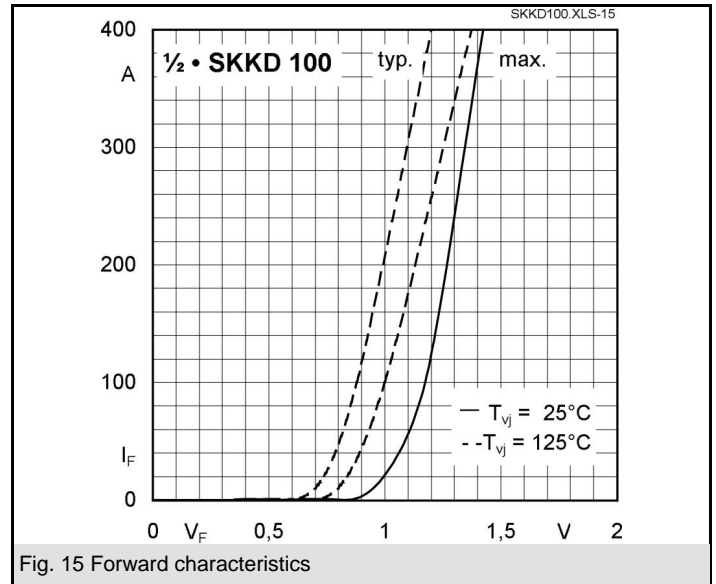
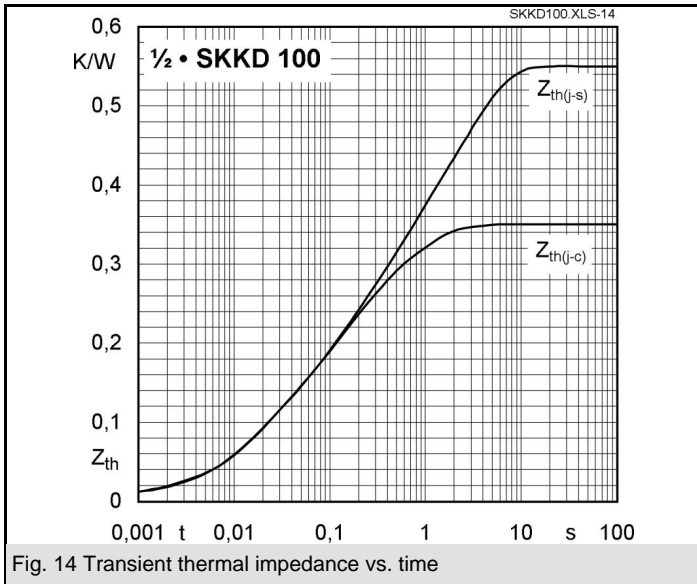

SKKD 100, SKMD 100

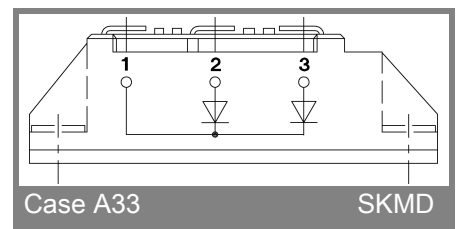
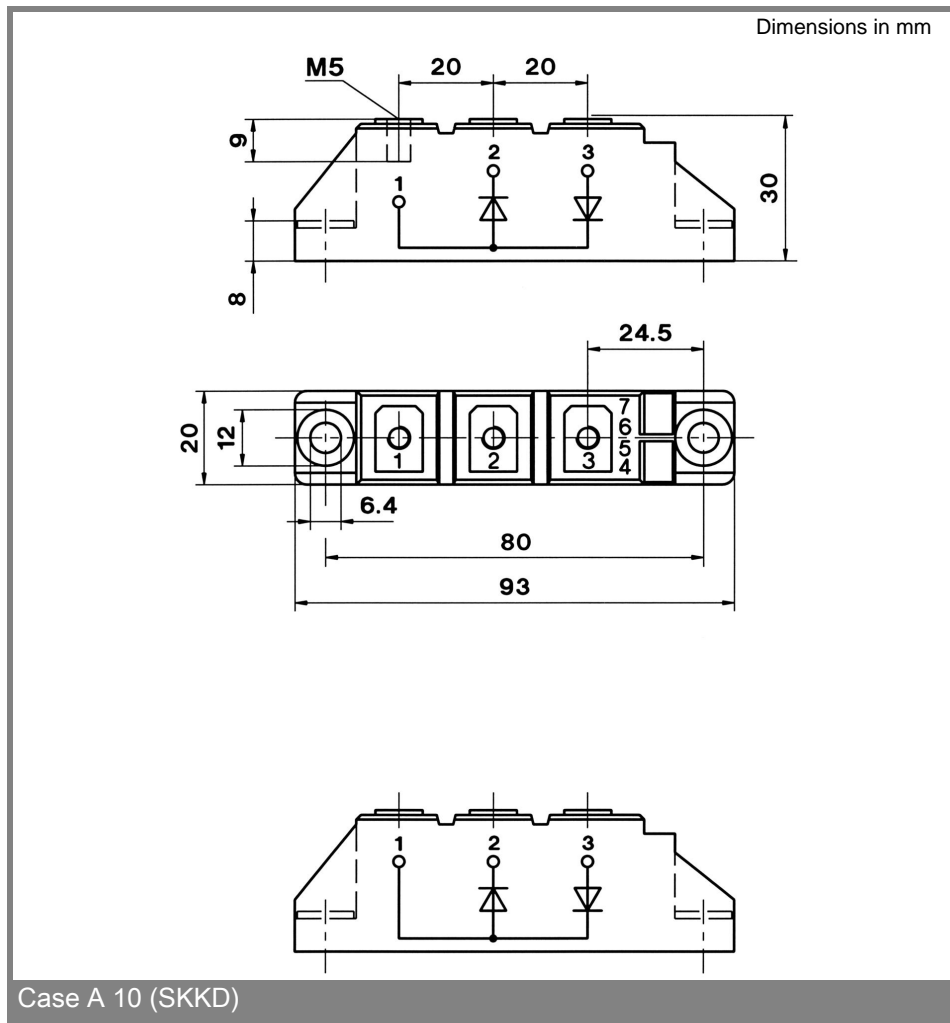

This technical information specifies semiconductor devices but promises no characteristics. No warranty or guarantee expressed or implied is made regarding delivery, performance or suitability.