

Fast Recovery Rectifier Diodes

SKN 2 F 50
SKR 2 F 50



V _{RSM} V _{RRM}	I _F RMS (maximum values for continuous operation)	
	100 A	
V	I _{FAV} (sin. 180; T _{case} = . . .)	
	50 A (105 °C)	50 A (95 °C)
	t _{rr} = 200 ns	
400	SKN 2 F 50/04 SKN 2 F 50/04 UNF	SKR 2 F 50/04 SKR 2 F 50/04 UNF
600	SKN 2 F 50/06 SKN 2 F 50/06 UNF	SKR 2 F 50/06 SKR 2 F 50/06 UNF
800	SKN 2 F 50/08 SKN 2 F 50/08 UNF	SKR 2 F 50/08 SKR 2 F 50/08 UNF
1000	SKN 2 F 50/10 SKN 2 F 50/10 UNF	SKR 2 F 50/10 SKR 2 F 50/10 UNF

Symbol	Conditions	SKN 2 F 50	SKR 2 F 50	Units
I _{FAV}	sin.180; (T _{case} = . . .); f = 5000 Hz	50 (105 °C)	50 (95 °C)	A
	sin.180/rec.120; T _{amb} = 45 °C; K5 K3 K1,1	12/11	12/11	A
		18/17	17/16	A
		33/31	31/29	A
I _{FSM}	T _{vj} = 25 °C; 10 ms	1100	800	A
	T _{vj} = 150 °C; 10 ms	940	670	A
i ² t	T _{vj} = 25 °C; 8,3 ... 10 ms	6000	3200	A ² s
	T _{vj} = 150 °C; 8,3 ... 10 ms	4400	2200	A ² s
Q _{rr}	} T _{vj} = 130 °C; I _F = 100 A; - d _I F = 30 $\frac{A}{\mu s}$; V _R = 30 V	3		μC
I _{RM}		10		A
I _R	T _{vj} = 25 °C; V _R = V _{RRM}	0,4		mA
	T _{vj} = 130 °C; V _R = V _{RRM}	50		mA
t _{rr}	} T _{vj} = 25 °C T _{vj} = 130 °C } I _F = I _R = 1 A	max. 200		ns
		typ. 400		ns
V _F	T _{vj} = 25 °C; I _F = 50 A	max. 1,8		V
V _(TO)	T _{vj} = 150 °C	1,2		V
r _T	T _{vj} = 150 °C	4		mΩ
R _{thjc}		0,5	0,65	°C/W
R _{thch}		0,25		°C/W
T _{vj}		- 40 ... + 150		°C
T _{stg}		- 55 ... + 150		°C
M		SI units	2,5	
	US units	22		lb.in.
a		5 · 9,81		m/s ²
w	approx.	20		g
Case		E10		

Features

- Small recovered charge
- Soft recovery
- Up to 1000 V reverse voltage
- Hermetic metal cases with glass insulators
- Threaded studs ISO M6 or 1/4-28 UNF
- **SKN**: anode to stud
- **SKR**: cathode to stud

Typical Applications

- Inverse diodes for power transistors, GTO thyristors, asymmetric thyristors
- SMPS, inverters, choppers
- For severe ambient conditions

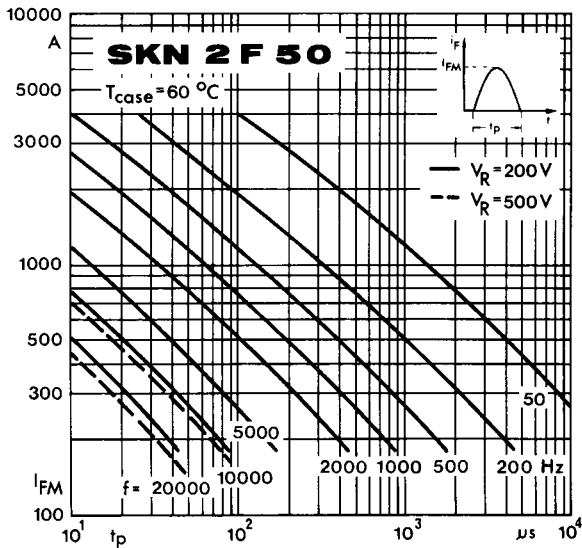

Fig. 1 a Rated sinusoidal peak forward current

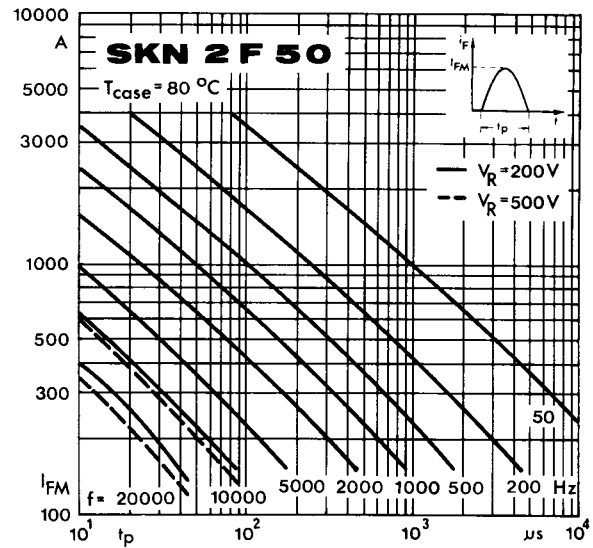

Fig. 1 b Rated sinusoidal peak forward current

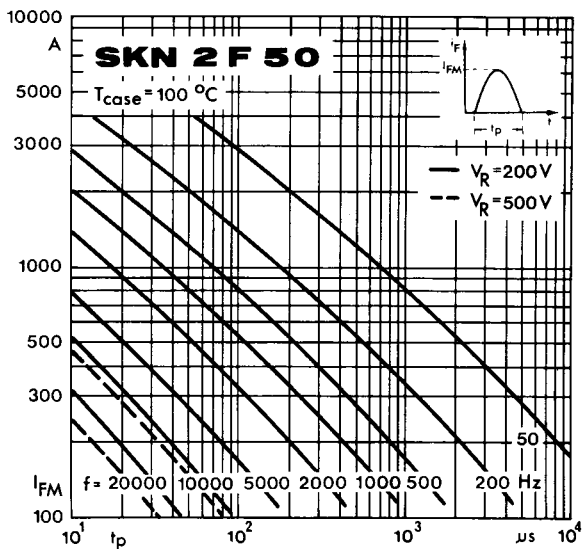

Fig. 1 c Rated sinusoidal peak forward current

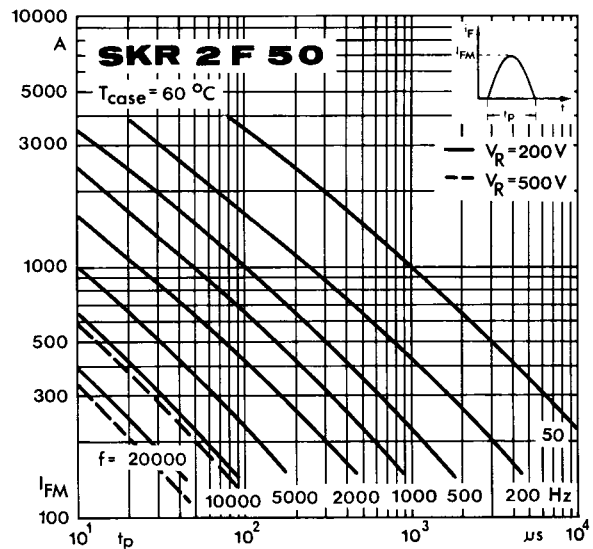

Fig. 1 d Rated sinusoidal peak forward current

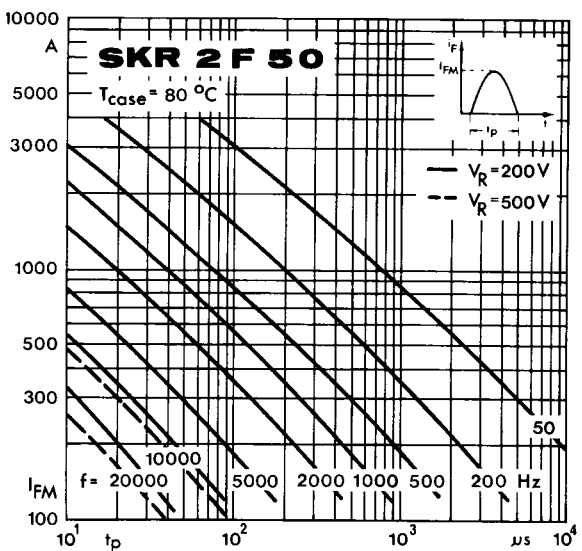

Fig. 1 e Rated sinusoidal peak forward current

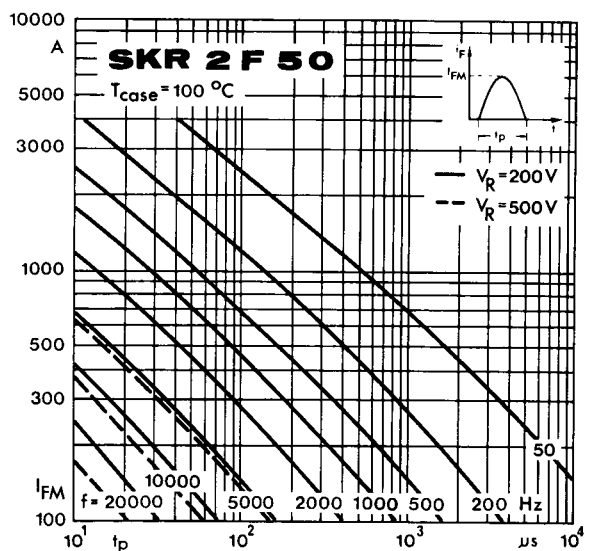

Fig. 1 f Rated sinusoidal peak forward current

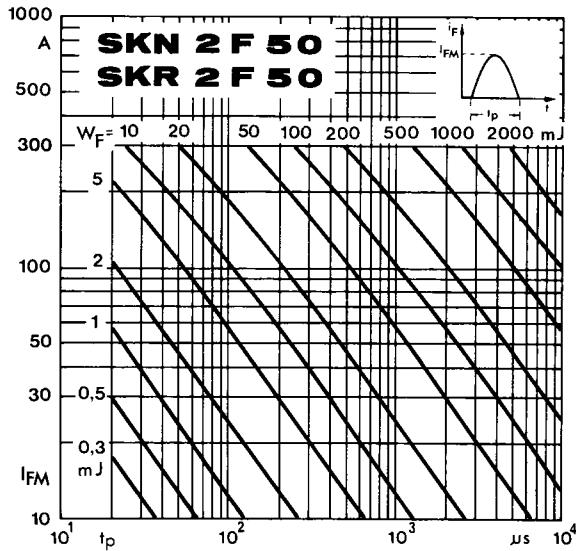

Fig. 2 Forward energy dissipation, sinusoidal

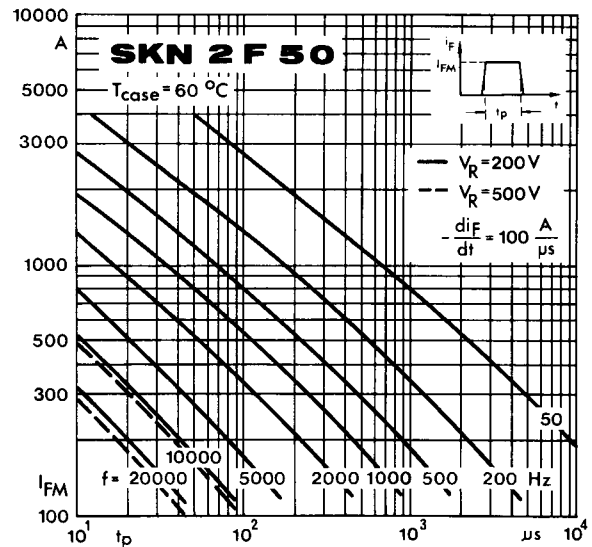

Fig. 3 a Rated rectangular peak forward current

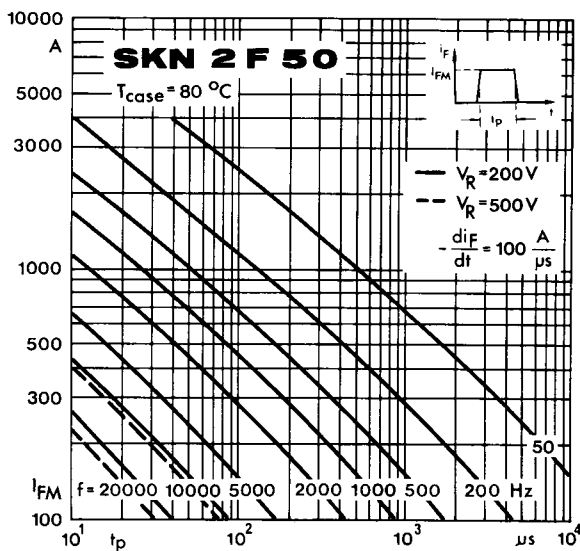

Fig. 3 b Rated rectangular peak forward current

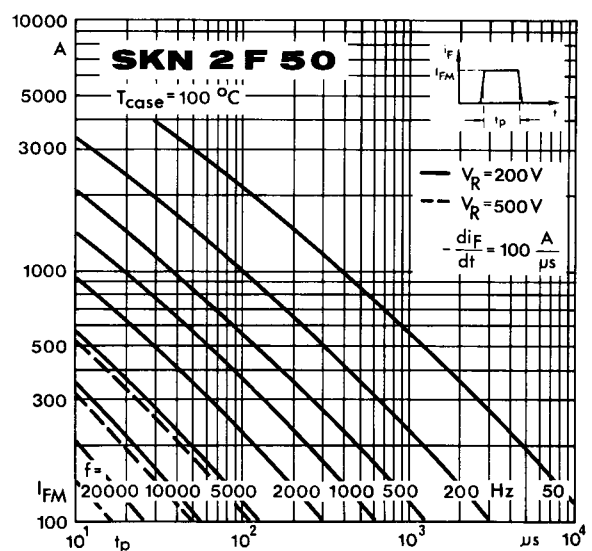

Fig. 3 c Rated rectangular peak forward current

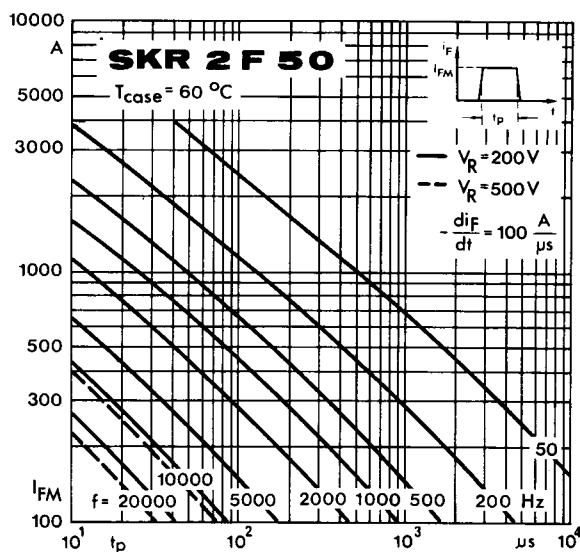

Fig. 3 d Rated rectangular peak forward current

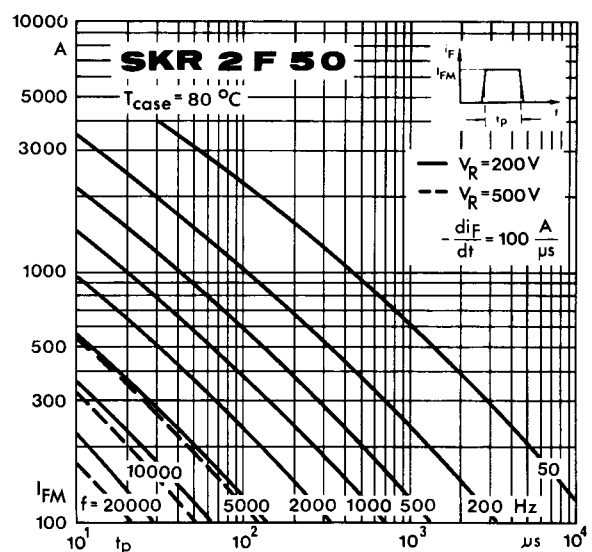

Fig. 3 e Rated rectangular peak forward current

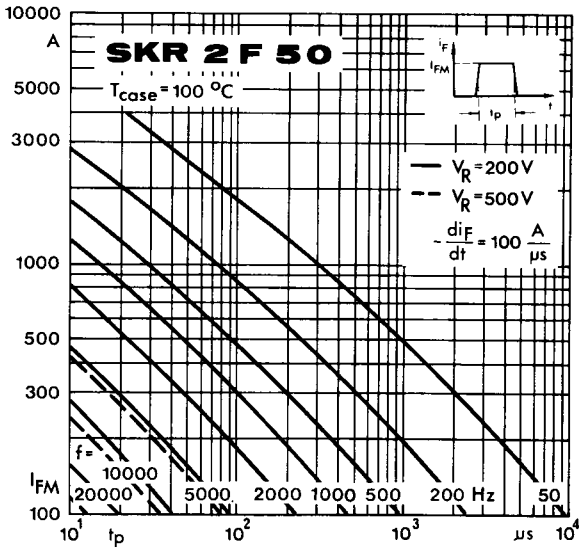

Fig. 3 f Rated rectangular peak forward current

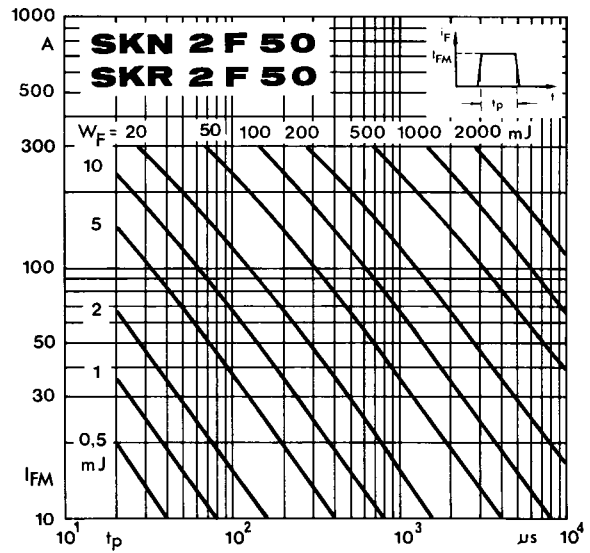

Fig. 4 Forward energy dissipation, rectangular

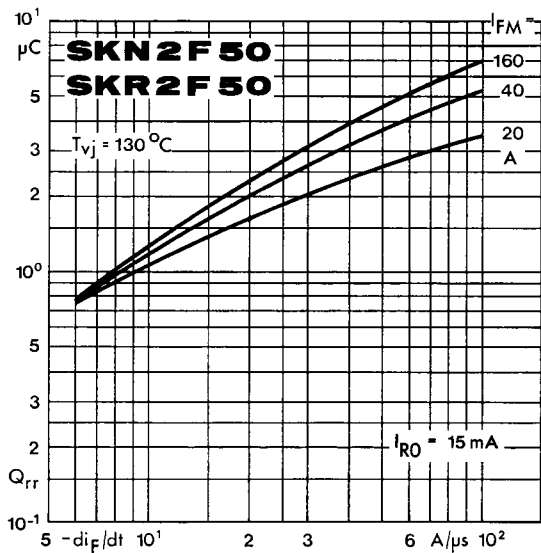

Fig. 5 Recovered charge

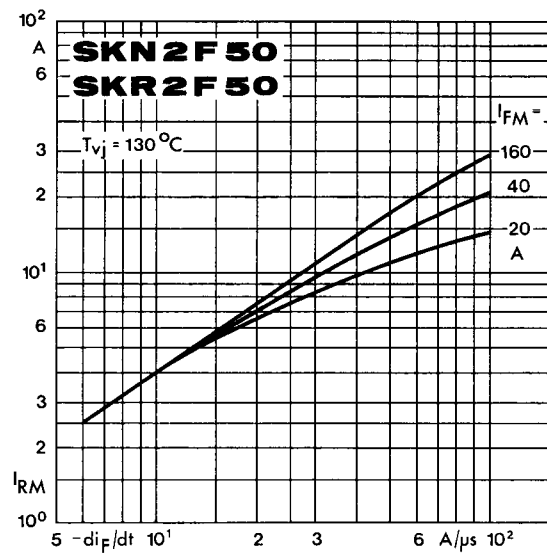

Fig. 6 Peak reverse recovery current

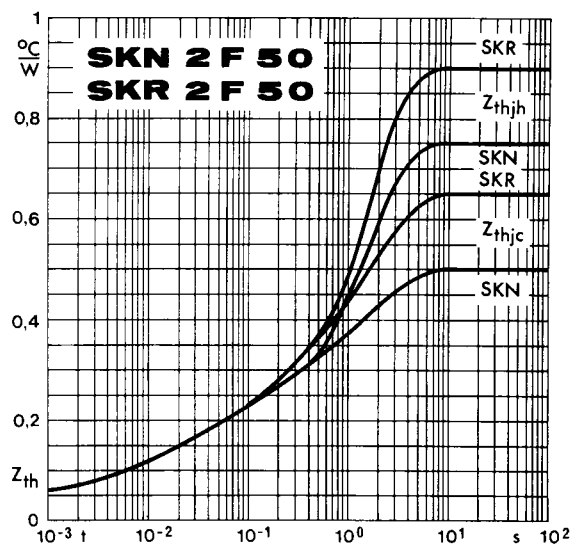

Fig. 7 Transient thermal impedance

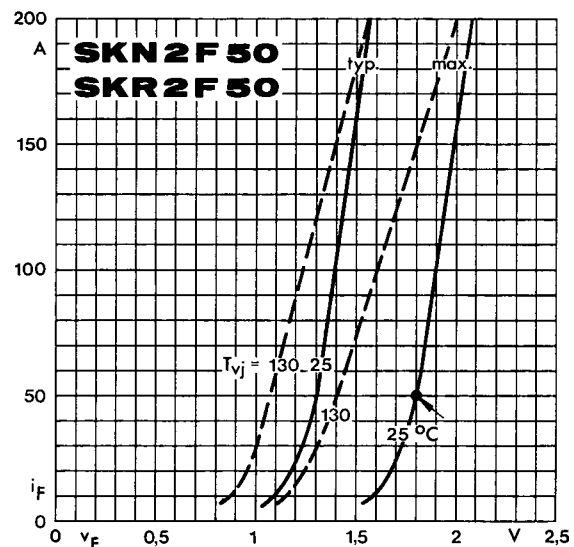

Fig. 8 Forward characteristics

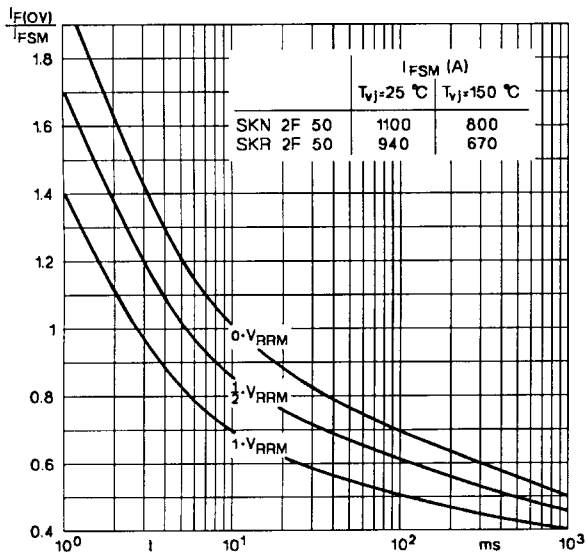
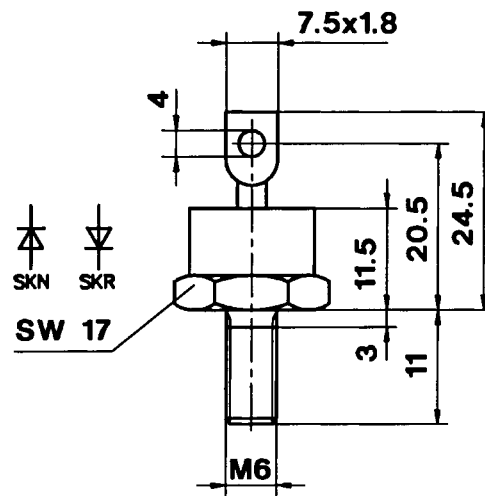

Fig. 9 Rated surge overload current

SKN 2 F 50
SKR 2 F 50

Case E 10

IEC-Publ. 191-2: A 4 M



Dimensions in mm

SKN 2 F 50 ... UNF
SKR 2 F 50 ... UNF

Case E 10 UNF

IEC-Publ. 191-2: A 4 U
JEDEC: DO-203 AB (DO-5)

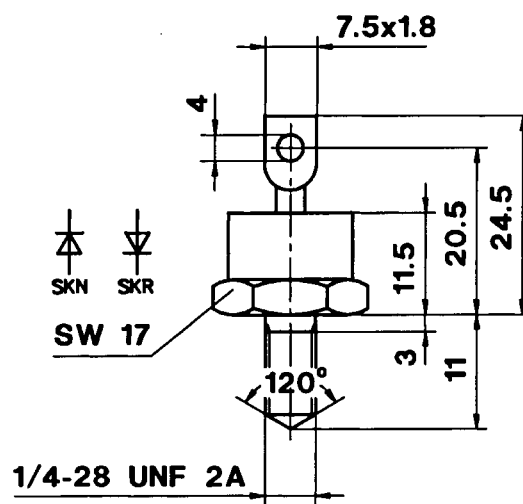

Dimensions in mm