

## Fast Recovery Rectifier Diodes

**SKN 2 F 17 SKR 2 F 17**  
**SKN 3 F 20 SKR 3 F 20**



V <sub>RSM</sub> V <sub>RRM</sub>	I <sub>FRMS</sub> (maximum values for continuous operation)			
	41 A			
V	I <sub>FAV</sub> (sin. 180; T <sub>case</sub> = 85 °C)			
	26 A			
	t <sub>rr</sub> = 150 ns		t <sub>rr</sub> = 250 ns	
	△	▽	△	▽
400	SKN 2F17/04 SKN 2F17/04UNF	SKR 2F17/04 SKR 2F17/04UNF	-	-
600	SKN 2F17/06 SKN 2F17/06UNF	SKR 2F17/06 SKR 2F17/06UNF		
800	SKN 2F17/08 SKN 2F17/08UNF	SKR 2F17/08 SKR 2F17/08UNF	SKN 3F20/08 SKN 3F20/08UNF	SKR 3F20/08 SKR 3F20/08UNF
1000	SKN 2F17/10 SKN 2F17/10UNF	SKR 2F17/10 SKR 2F17/10UNF	SKN 3F20/10 SKN 3F20/10UNF	SKR 3F20/10 SKR 3F20/10UNF
1200	-	-	SKN 3F20/12 SKN 3F20/12UNF	SKR 3F20/12 SKR 3F20/12UNF

Symbol	Conditions	SKN 2 F 17 SKR 2 F 17	SKN 3 F 20 SKR 3 F 20	Units
I <sub>FAV</sub>	sin. 180; T <sub>case</sub> = 85 °C; f=5000 Hz = 104 °C = 113 °C sin. 180/rec. 120; T <sub>amb</sub> = 5 °C; K9 K5	26 - 17	26 20 -	A A A A A
I <sub>FSM</sub>	T <sub>vj</sub> = 25 °C; 10 ms T <sub>vj</sub> = 150 °C; 10 ms	450 380	375 310	A A
i <sup>2</sup> t	T <sub>vj</sub> = 25 °C; 8,3 ... 10 ms T <sub>vj</sub> = 150 °C; 8,3 ... 10 ms	1000 720	700 480	A <sup>2</sup> s A <sup>2</sup> s
Q <sub>rr</sub>	T <sub>vj</sub> = 130 °C; I <sub>F</sub> = 50 A;	1,0	1,5	μC
I <sub>RM</sub>	$-\frac{dI_F}{dt} = 15 \frac{A}{\mu s}$ ; V <sub>R</sub> = 30 V	4,5	5	A
I <sub>R</sub>	T <sub>vj</sub> = 25 °C; V <sub>R</sub> = V <sub>RRM</sub> T <sub>vj</sub> = 130 °C; V <sub>R</sub> = V <sub>RRM</sub>	max. 0,2 max. 16	max. 0,2 max. 20	mA mA
t <sub>rr</sub>	T <sub>vj</sub> = 25 °C } I <sub>F</sub> = I <sub>R</sub> = 1 A T <sub>vj</sub> = 130 °C }	max. 150 typ. 300	max. 250 typ. 500	ns ns
V <sub>F</sub>	T <sub>vj</sub> = 25 °C; I <sub>F</sub> = 50 A	max. 2,15		V
V <sub>(TO)</sub>	T <sub>vj</sub> = 130 °C	1,3		V
r <sub>T</sub>	T <sub>vj</sub> = 130 °C	12		mΩ
R <sub>thjc</sub>		1,2		°C/W
R <sub>thch</sub>		0,5		°C/W
T <sub>vj</sub>		- 40 ... + 150		°C
T <sub>stg</sub>		- 55 ... + 150		°C
M	SI units US units	1,5 13		Nm lb.in.
a		5 · 9,81		m/s <sup>2</sup>
w		7		g
Case		E7		

### Features

- Small recovered charge
- Soft recovery
- Up to 1200 V reverse voltage
- Hermetic metal cases with glass insulators
- Threaded studs ISO M5 or 10-32 UNF
- **SKN**: anode to stud  
**SKR**: cathode to stud

### Typical Applications

- Inverse diodes for power transistors, GTO thyristors asymmetric thyristors
- SMPS, inverters, choppers
- For severe ambient conditions

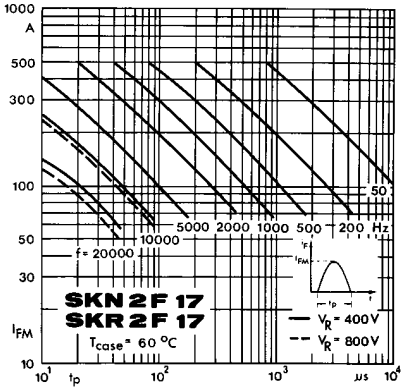

Fig. 1 a Rated sinusoidal peak forward current

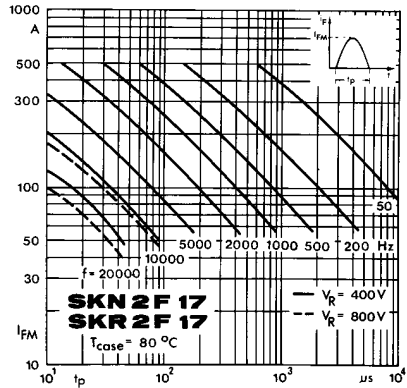

Fig. 1 b Rated sinusoidal peak forward current

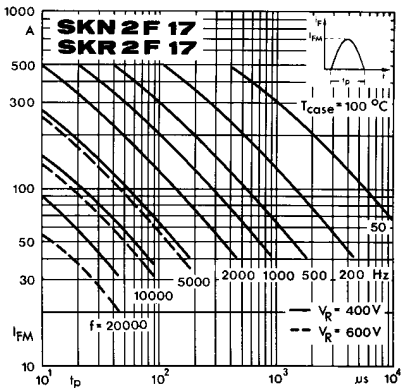

Fig. 1 c Rated sinusoidal peak forward current

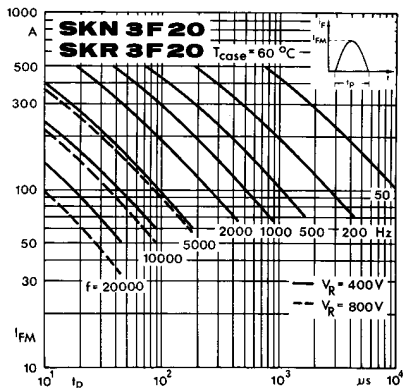

Fig. 1 d Rated sinusoidal peak forward current

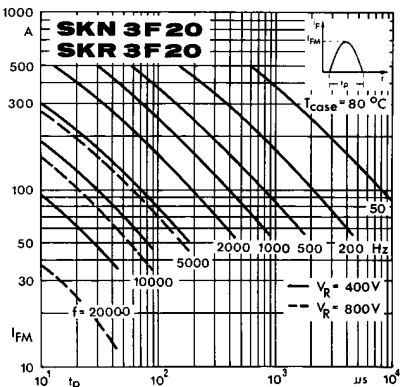

Fig. 1 e Rated sinusoidal peak forward current

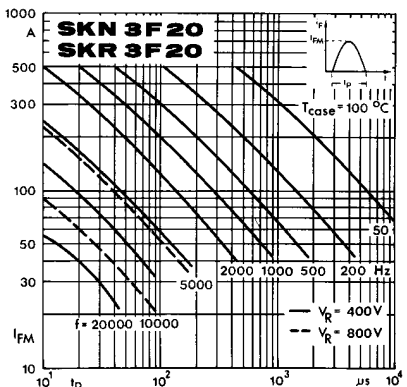

Fig. 1 f Rated sinusoidal peak forward current

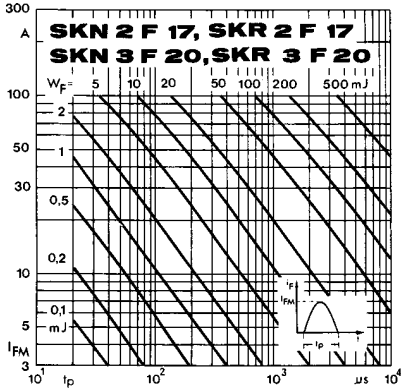

Fig. 2 Forward energy dissipation, sinusoidal

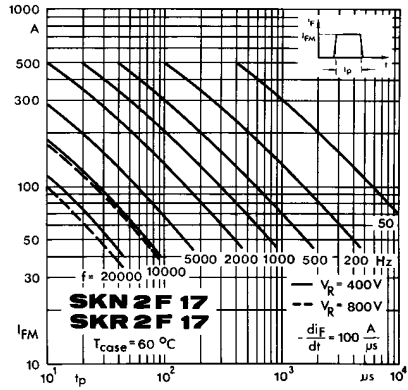

Fig. 3 a Rated rectangular peak forward current

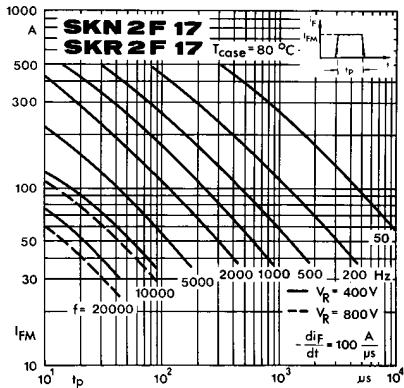

Fig. 3 b Rated rectangular peak forward current

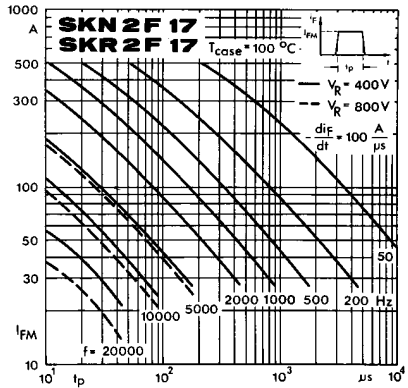

Fig. 3 c Rated rectangular peak forward current

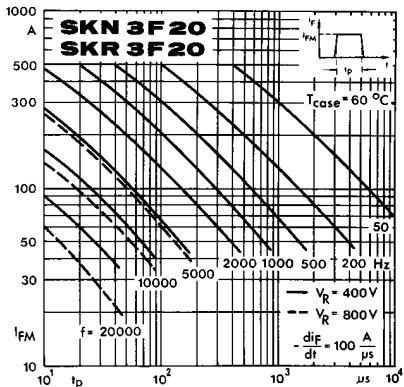

Fig. 3 d Rated rectangular peak forward current

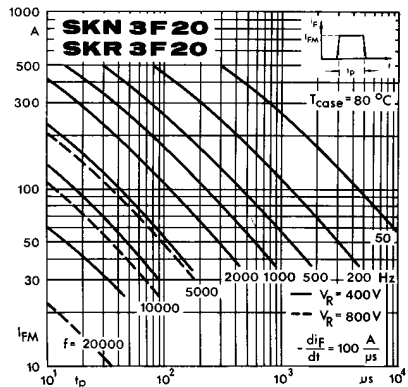

Fig. 3 e Rated rectangular peak forward current

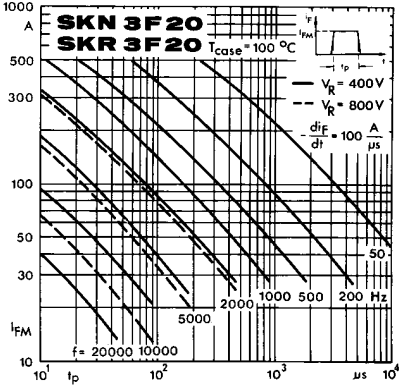

Fig. 3 f Rated rectangular peak forward current

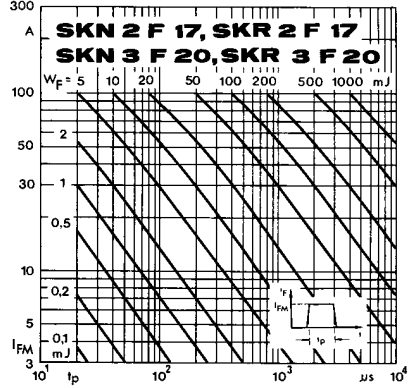

Fig. 4 Forward energy dissipation, rectangular

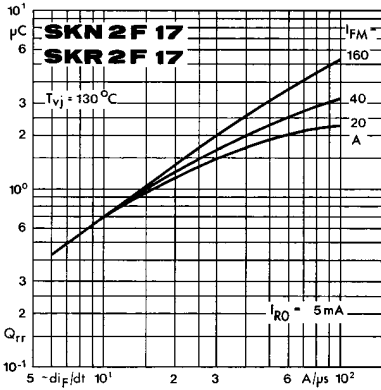

Fig. 5 a Recovered charge

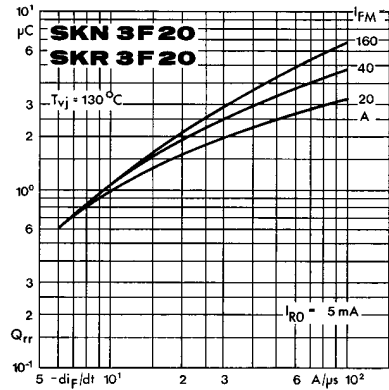

Fig. 5 b Recovered charge

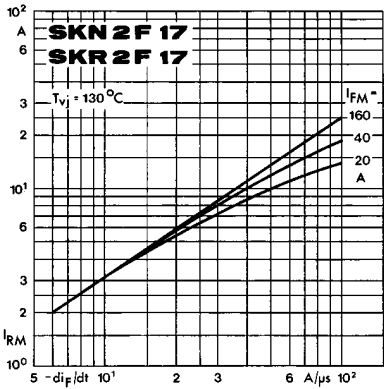

Fig. 6 a Peak reverse recovery current

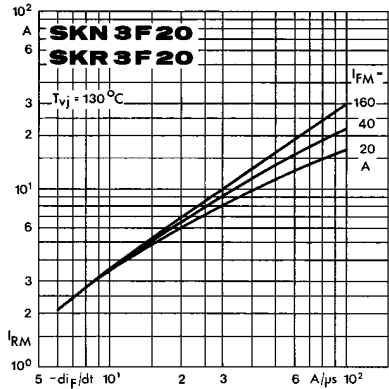

Fig. 6 b Peak reverse recovery current

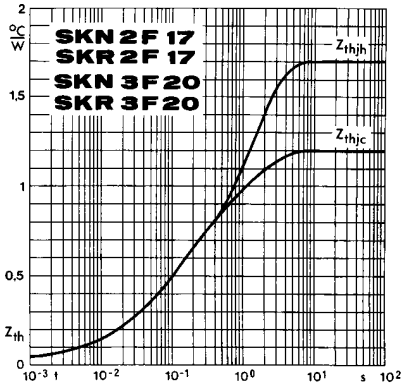

Fig. 7 Transient thermal impedance

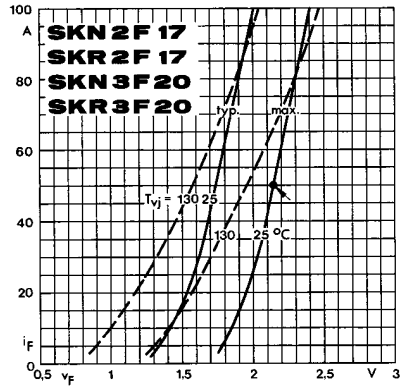

Fig. 8 Forward characteristics

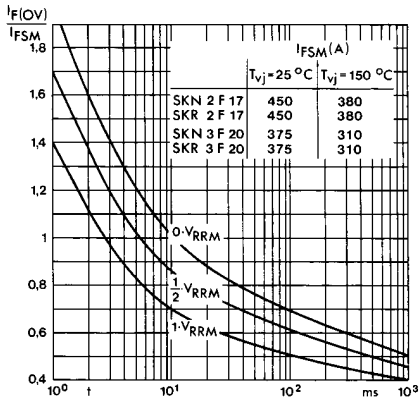
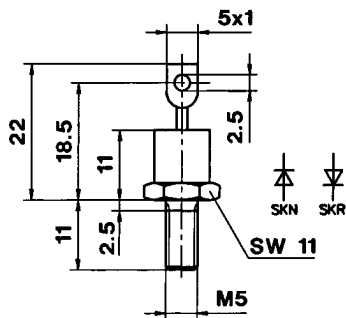

Fig 9 Rated surge overload current

**SKN 2 F 17**  
**SKR 2 F 17**  
**SKN 3 F 20**  
**SKR 3 F 20**

Case E 7

IEC-Publ. 191-2: A 3 M  
DIN 41 885: 101 C 2  
BS 3934: SO-10  
JEDEC: DO-203 AA (DO-4) metric



Dimensions in mm

**SKN 2 F 17 ... UNF**  
**SKR 2 F 17 ... UNF**  
**SKN 3 F 20 ... UNF**  
**SKR 3 F 20 ... UNF**

Case E 7 UNF

IEC-Publ. 191-2: A 3 U  
BS 3934: SO-10  
JEDEC: DO-203 AA (DO-4)

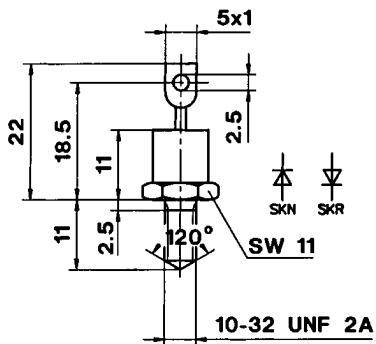

Dimensions in mm