



Disc Diode

Rectifier Diode

SKN 4000

Features

- Capsule type metal-ceramic package with precious metal pressure contacts
- Medium voltage, high current rectifier diode with slim package for lowest thermal resistance
- Low power dissipation
- Especially suited for water cooling
- Forward selections for paralleling available

Typical Applications

- Welding
- Electroplating

1) DSC - Double sided cooling
SSC - Single sided cooling

V_{RSM} V	V_{RRM} V	$I_{FRMS} = 6300$ A (maximum value for continuous operation) $I_{FAV} = 4000$ A (sin. 180; $T_c = 50$ °C)		
200	200	SKN 4000/02		
400	400	SKN 4000/04		
600	600	SKN 4000/06		

Symbol	Conditions	Values	Units
I_{FAV}	sin. 180; DSC ¹⁾ ; $T_c = 85$ (100) °C	3200 (2740)	A
I_{FSM}	$T_{vj} = 25$ °C; 10 ms $T_{vj} = 180$ °C; 10 ms	60000 50000	A A
i^2t	$T_{vj} = 25$ °C; 8,3 ... 10 ms $T_{vj} = 180$ °C; 8,3 ... 10 ms	18000000 12500000	A ² s A ² s
V_F	$T_{vj} = 25$ °C; $I_F = 14000$ A	max. 1,3	V
$V_{(TO)}$	$T_{vj} = 180$ °C	max. 0,7	V
r_T	$T_{vj} = 180$ °C	max. 0,04	mΩ
I_{RD}	$T_{vj} = 180$ °C; $V_{RD} = V_{RRM}$	max. 100	mA
$R_{th(j-c)}$	DSC / SSC ¹⁾	0,03 / 0,06	K/W
$R_{th(c-s)}$	DSC / SSC ¹⁾	0,005 / 0,01	K/W
T_{vj}		- 40 ... + 180	°C
T_{stg}		- 40 ... + 150	°C
V_{isol}		-	V~
F	mounting force	24 ... 30	kN
a			m/s ²
m	approx.	129	g
Case		E 35	



SKN

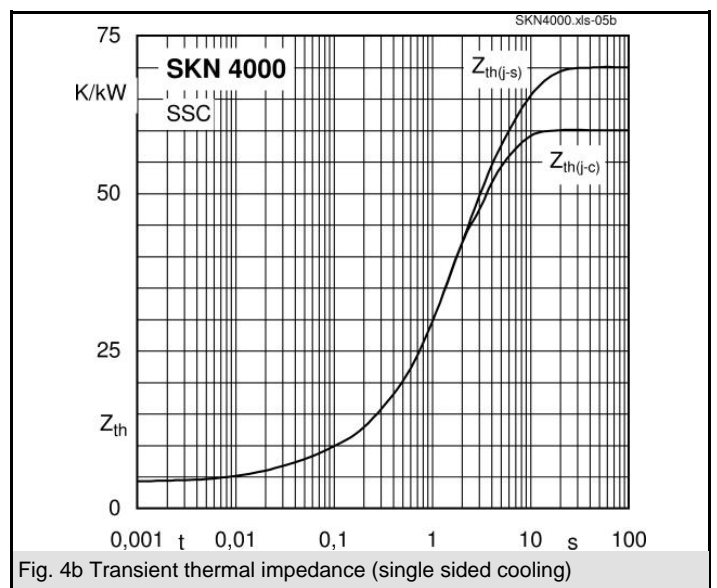
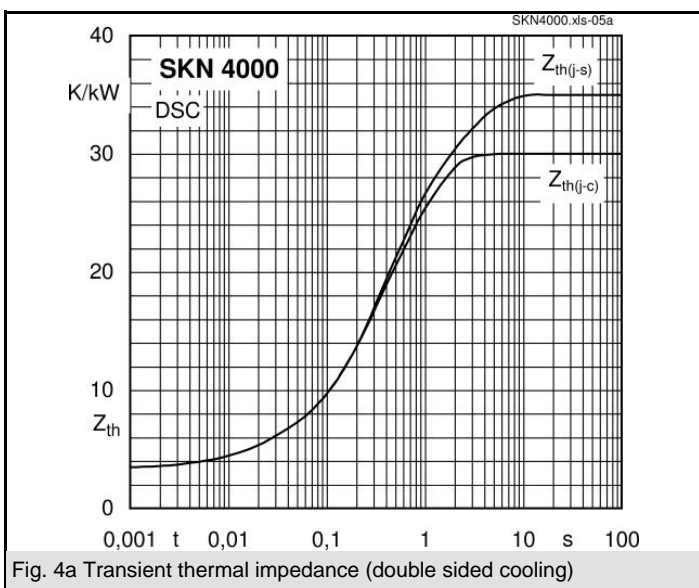
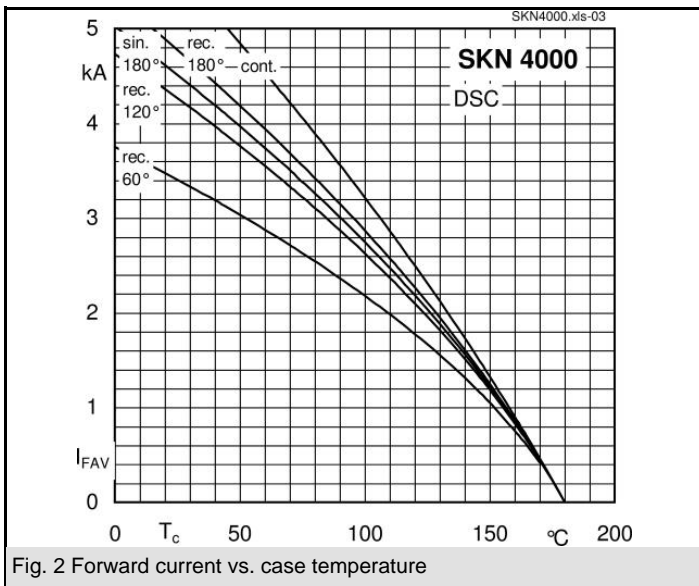
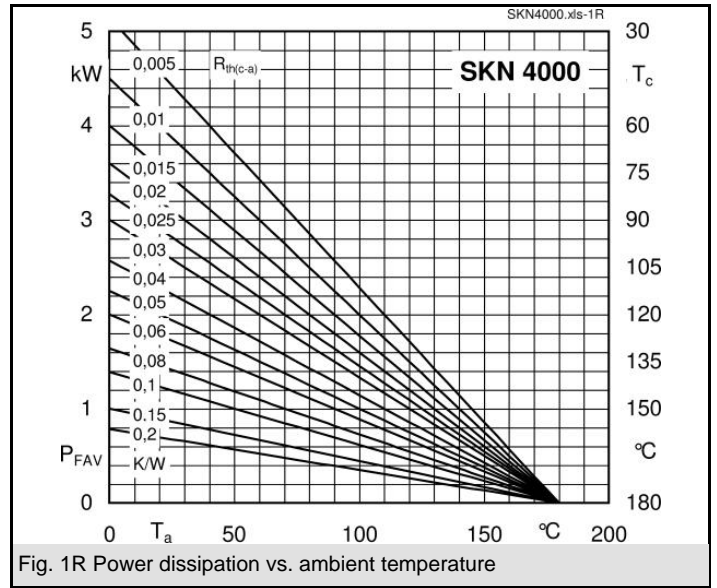
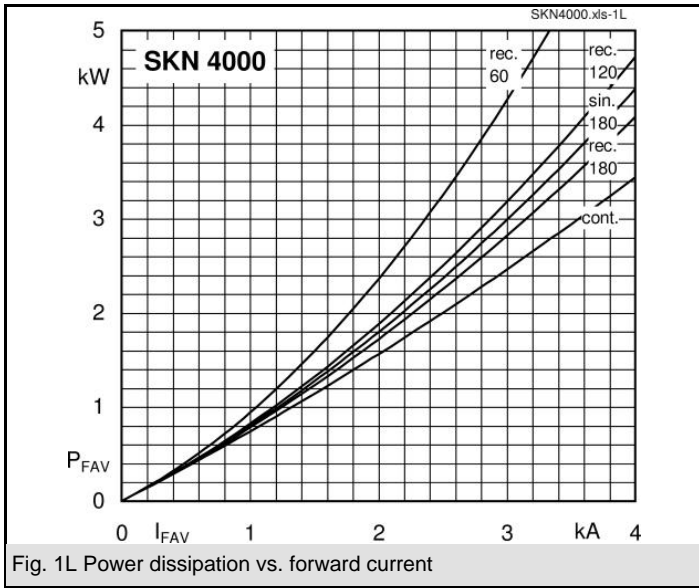

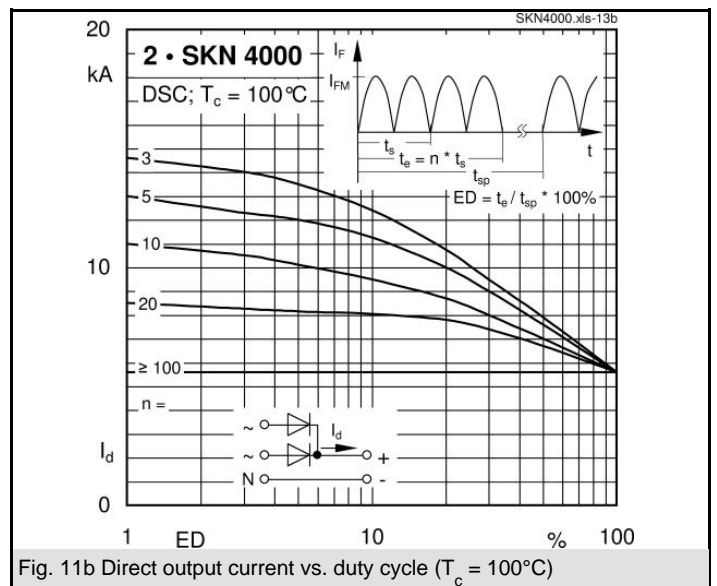
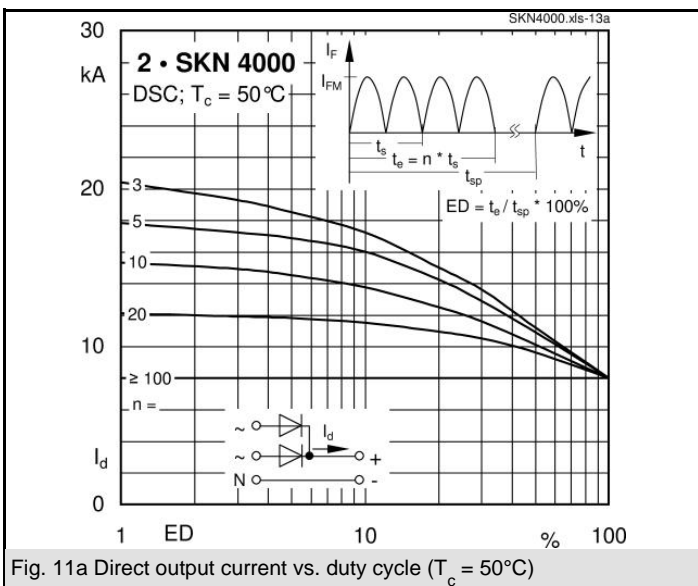
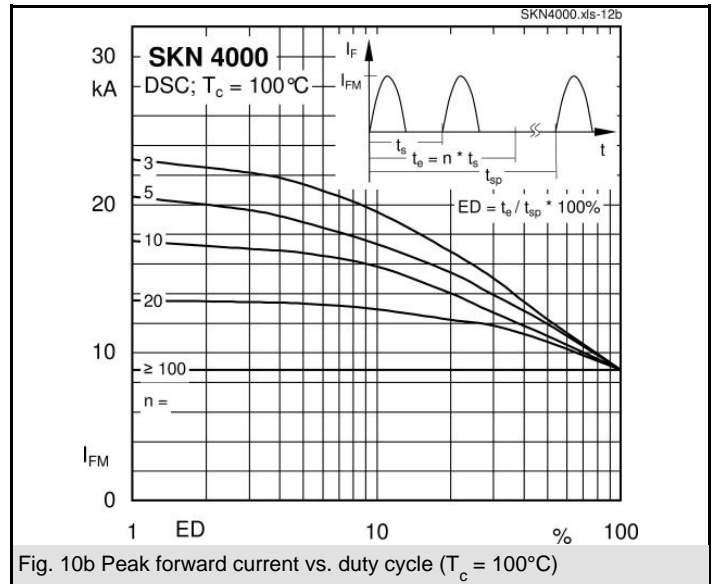
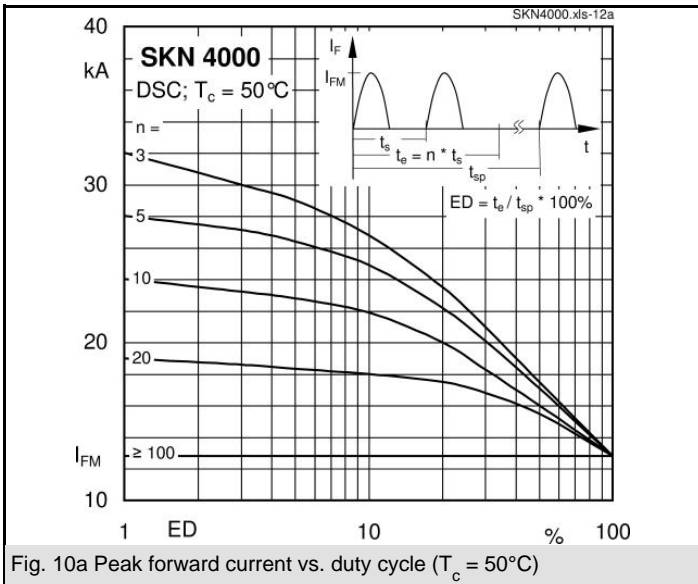
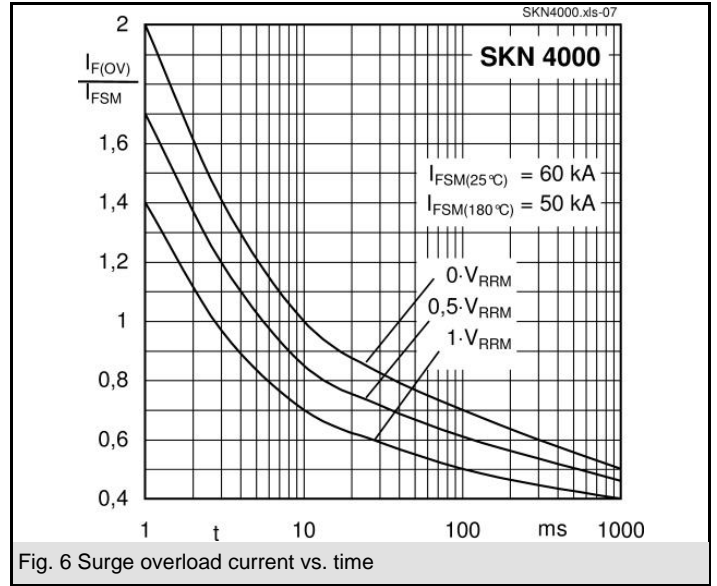
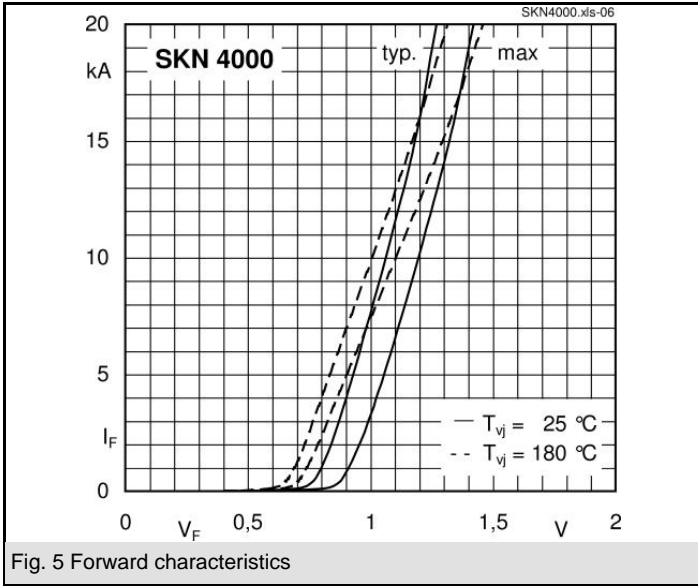

Dimensions in mm

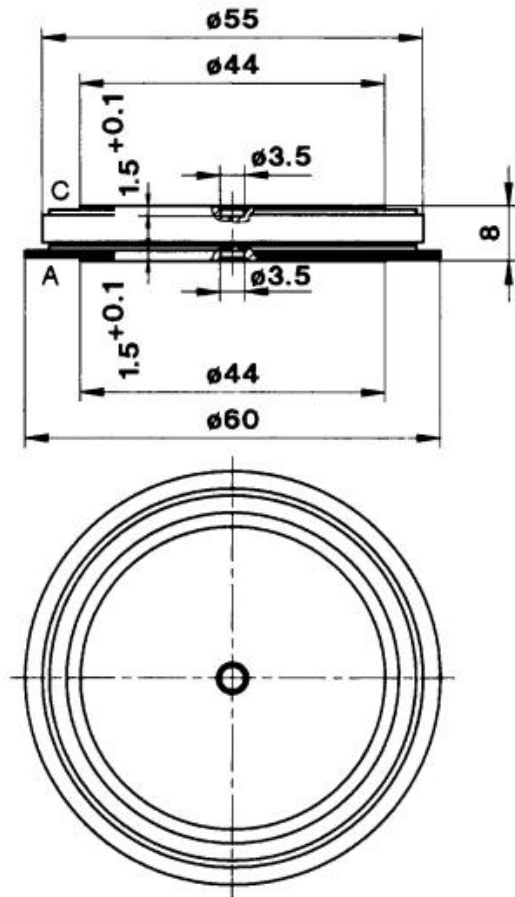

Case E 35

This technical information specifies semiconductor devices but promises no characteristics. No warranty or guarantee expressed or implied is made regarding delivery, performance or suitability.