

SKN 4000



Disc Diode

Rectifier Diode

SKN 4000

Features

- Capsule type metal-ceramic package with precious metal pressure contacts
- Medium voltage, high current rectifier diode with slim package for lowest thermal resistance
- Low power dissipation
- Especially suited for water cooling
- Forward selections for paralleling available

Typical Applications

- Welding
- Electroplating

1) DSC - Double sided cooling
SSC - Single sided cooling

| V_{RSM} V | V_{RRM} V | $I_{FRMS} = 6300$ A (maximum value for continuous operation) $I_{FAV} = 4000$ A (sin. 180; $T_c = 50$ °C) | | |
|----------------|----------------|--|--|--|
| 200 | 200 | SKN 4000/02 | | |
| 400 | 400 | SKN 4000/04 | | |
| 600 | 600 | SKN 4000/06 | | |

| Symbol | Conditions | Values | Units |
|---------------|---|----------------------|--------------------------------------|
| I_{FAV} | sin. 180; DSC ¹⁾ ; $T_c = 85$ (100) °C | 3200 (2740) | A |
| I_{FSM} | $T_{vj} = 25$ °C; 10 ms $T_{vj} = 180$ °C; 10 ms | 60000 50000 | A A |
| i^2t | $T_{vj} = 25$ °C; 8,3 ... 10 ms $T_{vj} = 180$ °C; 8,3 ... 10 ms | 18000000 12500000 | A ² s A ² s |
| V_F | $T_{vj} = 25$ °C; $I_F = 14000$ A | max. 1,3 | V |
| $V_{(TO)}$ | $T_{vj} = 180$ °C | max. 0,7 | V |
| r_T | $T_{vj} = 180$ °C | max. 0,04 | mΩ |
| I_{RD} | $T_{vj} = 180$ °C; $V_{RD} = V_{RRM}$ | max. 100 | mA |
| $R_{th(j-c)}$ | DSC / SSC ¹⁾ | 0,03 / 0,06 | K/W |
| $R_{th(c-s)}$ | DSC / SSC ¹⁾ | 0,005 / 0,01 | K/W |
| T_{vj} | | - 40 ... + 180 | °C |
| T_{stg} | | - 40 ... + 150 | °C |
| V_{isol} | | - | V~ |
| F | mounting force | 24 ... 30 | kN |
| a | | | m/s ² |
| m | approx. | 129 | g |
| Case | | E 35 | |

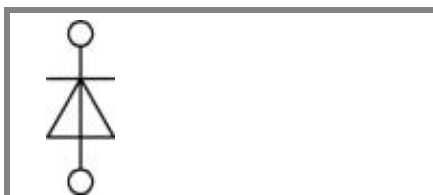

SKN

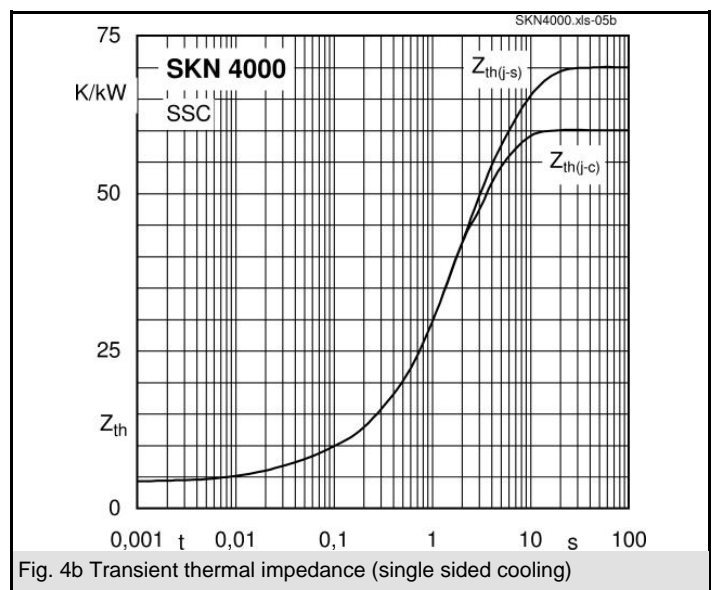
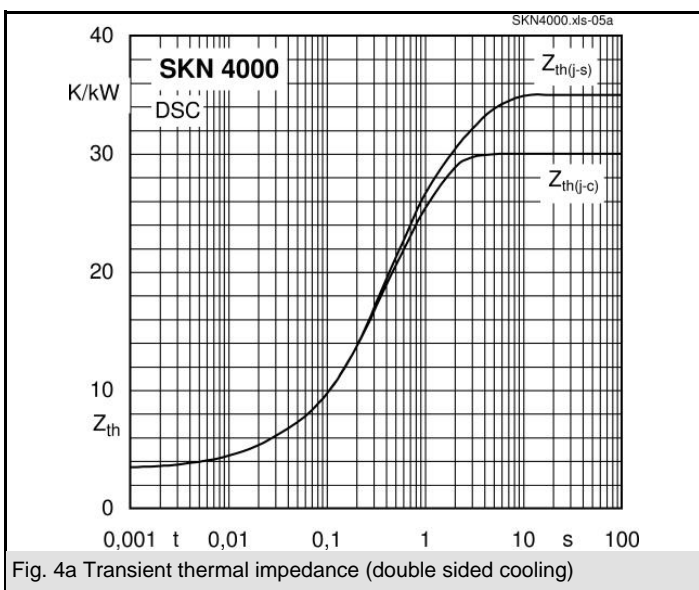
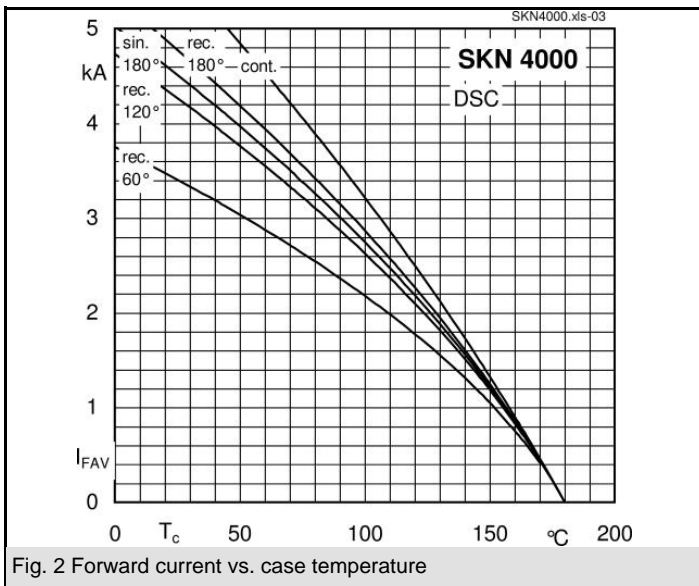
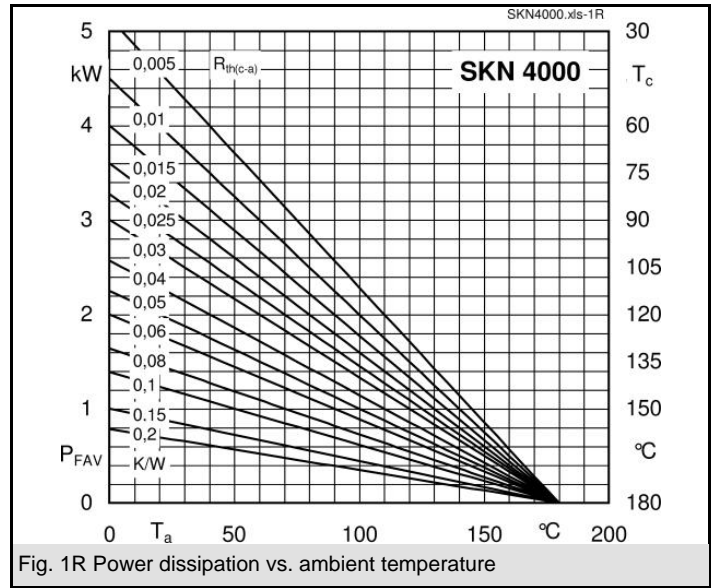
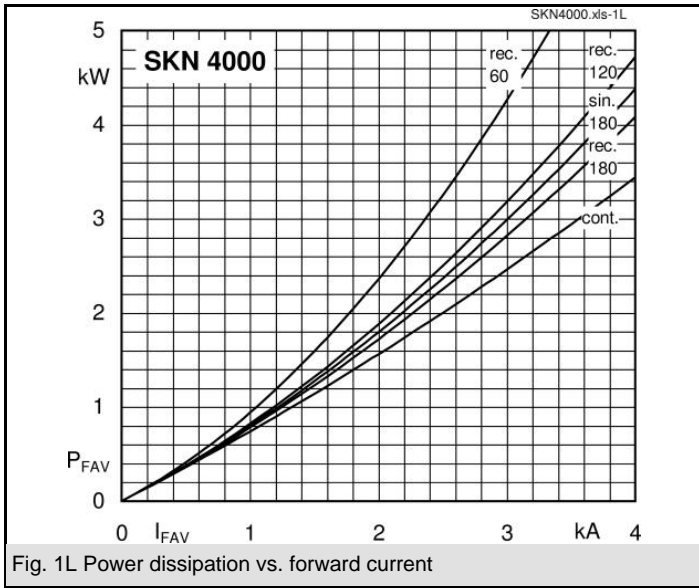

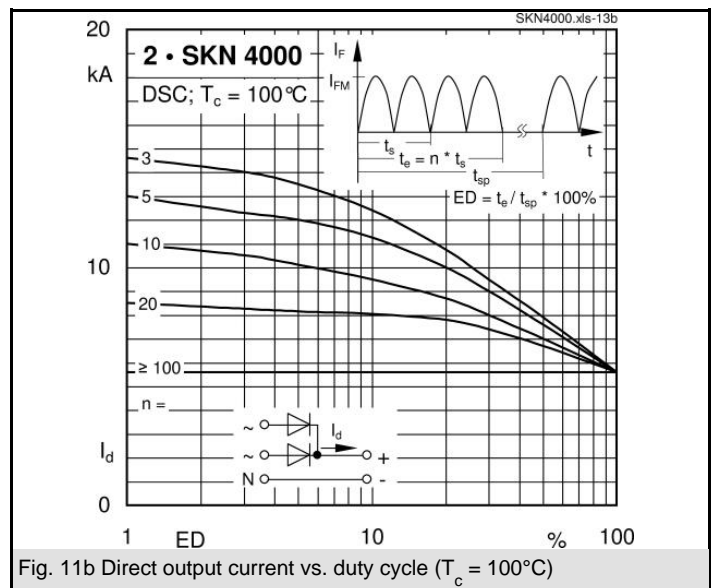
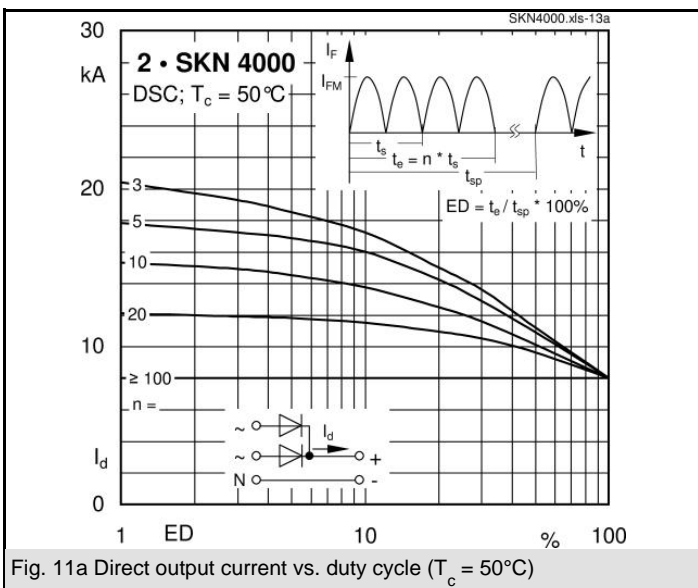
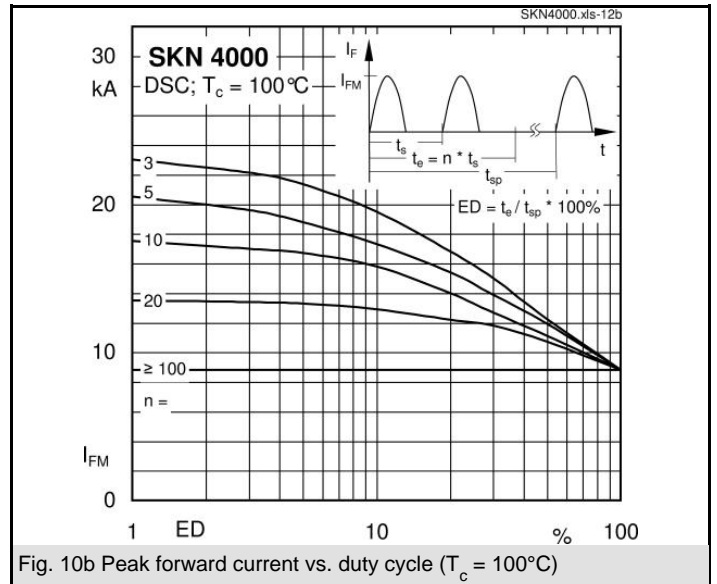
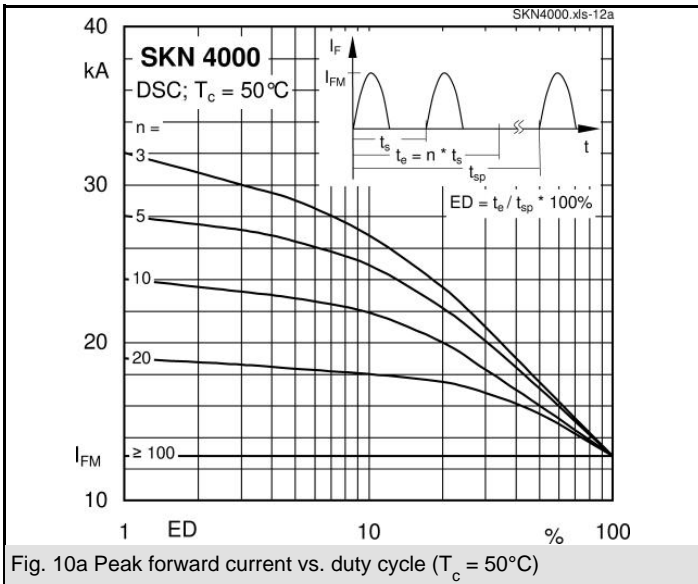
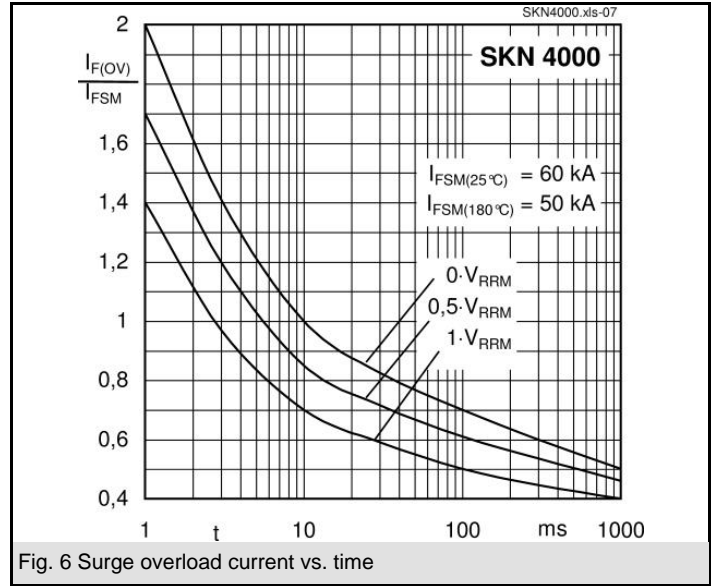
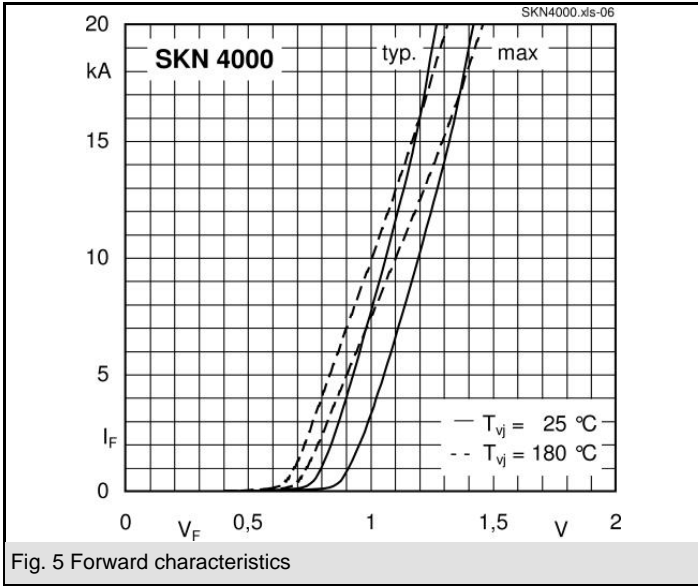

Dimensions in mm

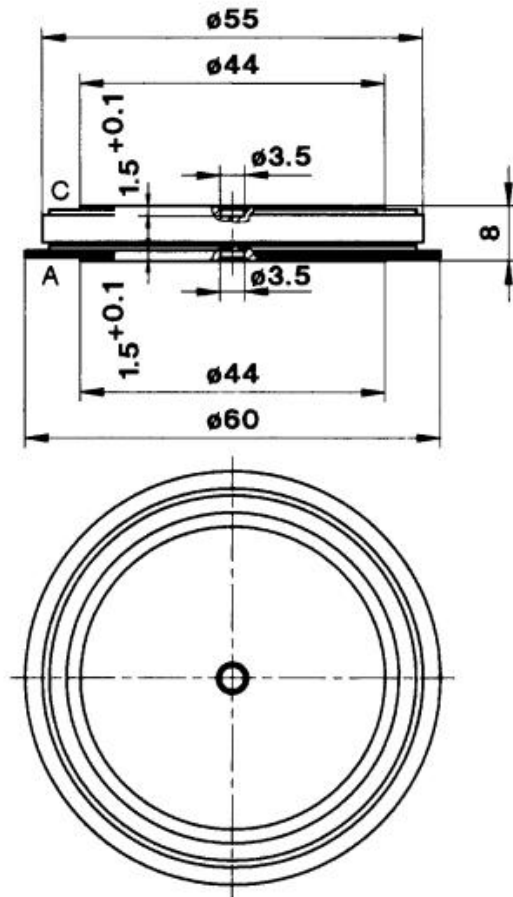

Case E 35

This technical information specifies semiconductor devices but promises no characteristics. No warranty or guarantee expressed or implied is made regarding delivery, performance or suitability.