

# SKN 4000



**Disc Diode**

## Rectifier Diode

### SKN 4000

#### Features

- Capsule type metal-ceramic package with precious metal pressure contacts
- Medium voltage, high current rectifier diode with slim package for lowest thermal resistance
- Low power dissipation
- Especially suited for water cooling
- Forward selections for paralleling available

#### Typical Applications

- Welding
- Electroplating

- 1) DSC - Double sided cooling  
SSC - Single sided cooling

$V_{RSM}$ V	$V_{RRM}$ V	$I_{FRMS} = 6300$ A (maximum value for continuous operation) $I_{FAV} = 4000$ A (sin. 180; $T_c = 50$ °C)		
200	200	SKN 4000/02		
400	400	SKN 4000/04		
600	600	SKN 4000/06		

Symbol	Conditions	Values	Units
$I_{FAV}$	sin. 180; DSC <sup>1)</sup> ; $T_c = 85$ (100) °C	3200 (2740)	A
$I_{FSM}$	$T_{vj} = 25$ °C; 10 ms $T_{vj} = 180$ °C; 10 ms	60000 50000	A A
$i^2t$	$T_{vj} = 25$ °C; 8,3 ... 10 ms $T_{vj} = 180$ °C; 8,3 ... 10 ms	18000000 12500000	A <sup>2</sup> s A <sup>2</sup> s
$V_F$	$T_{vj} = 25$ °C; $I_F = 14000$ A	max. 1,3	V
$V_{(TO)}$	$T_{vj} = 180$ °C	max. 0,7	V
$r_T$	$T_{vj} = 180$ °C	max. 0,04	mΩ
$I_{RD}$	$T_{vj} = 180$ °C; $V_{RD} = V_{RRM}$	max. 100	mA
$R_{th(j-c)}$	DSC / SSC <sup>1)</sup>	0,03 / 0,06	K/W
$R_{th(c-s)}$	DSC / SSC <sup>1)</sup>	0,005 / 0,01	K/W
$T_{vj}$		- 40 ... + 180	°C
$T_{stg}$		- 40 ... + 150	°C
$V_{isol}$		-	V~
F	mounting force	24 ... 30	kN
a			m/s <sup>2</sup>
m	approx.	129	g
Case		E 35	



SKN

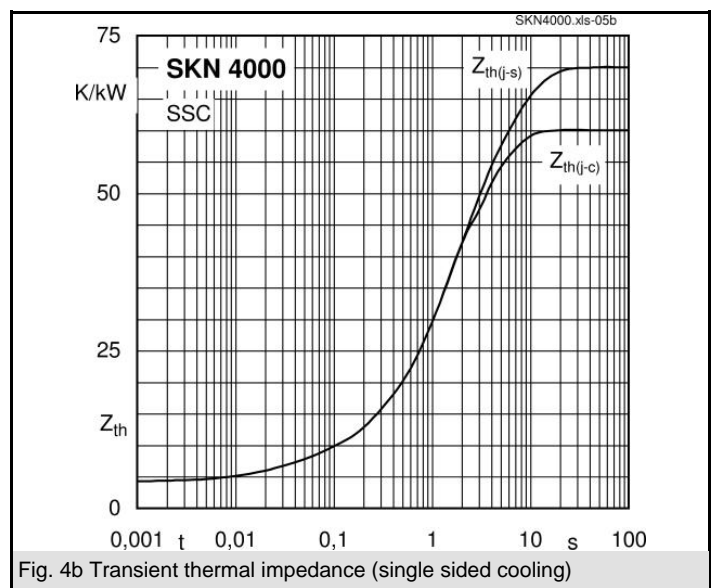
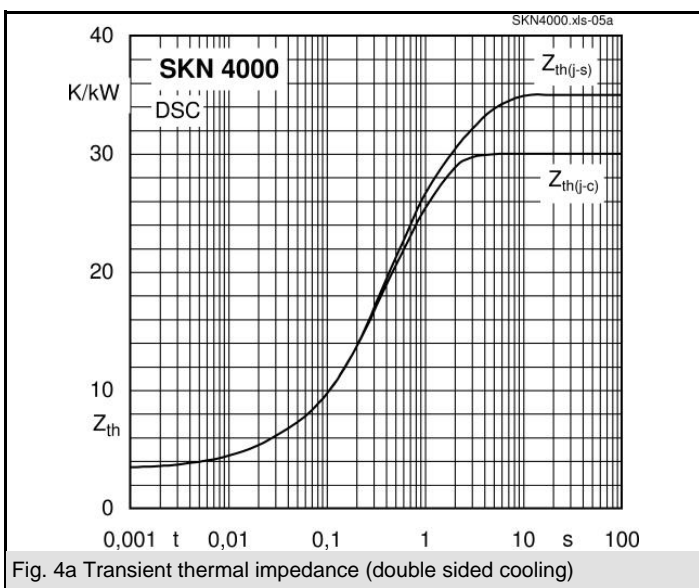
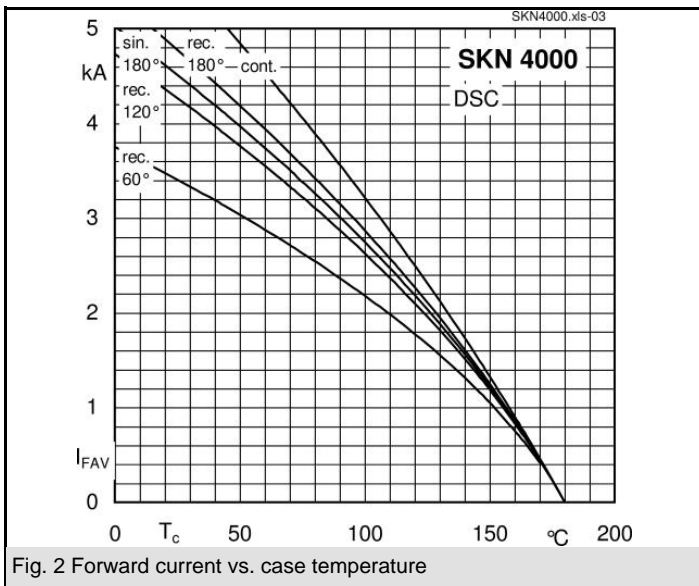
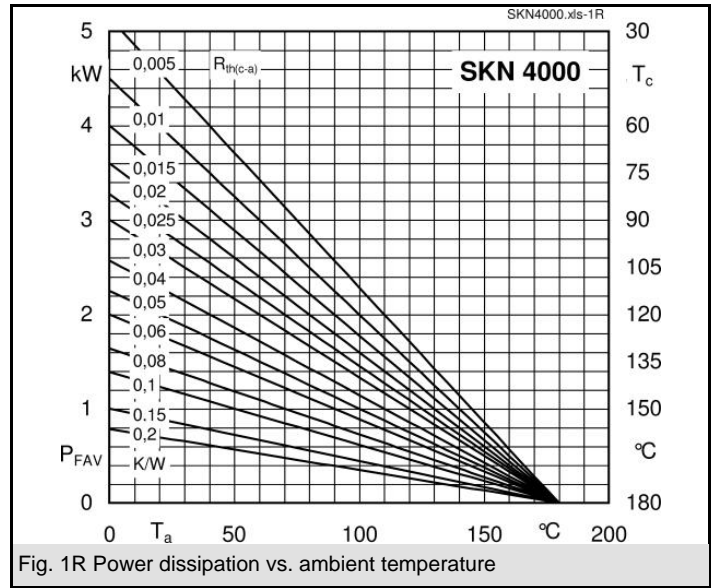
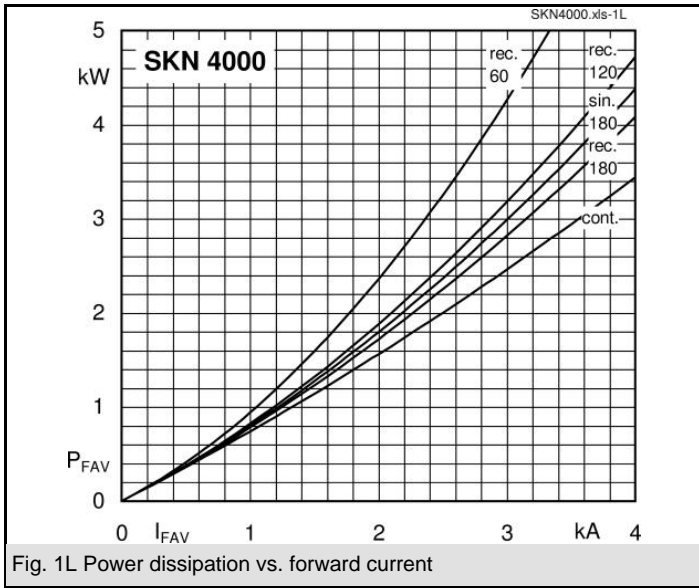

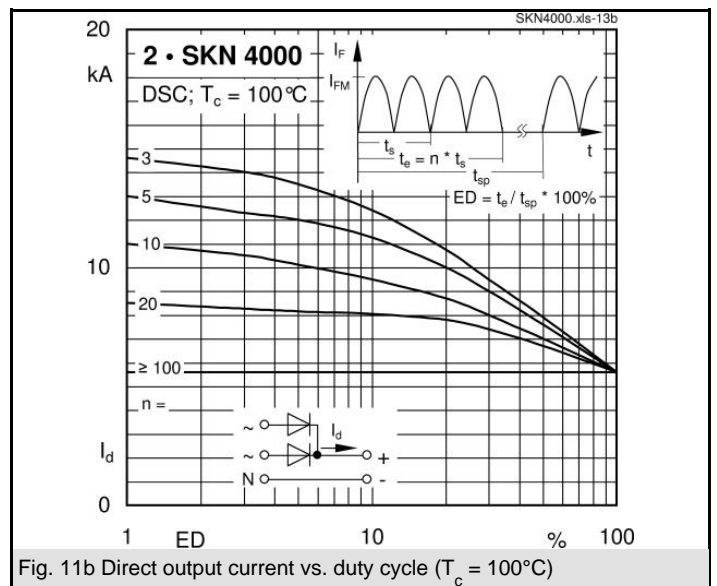
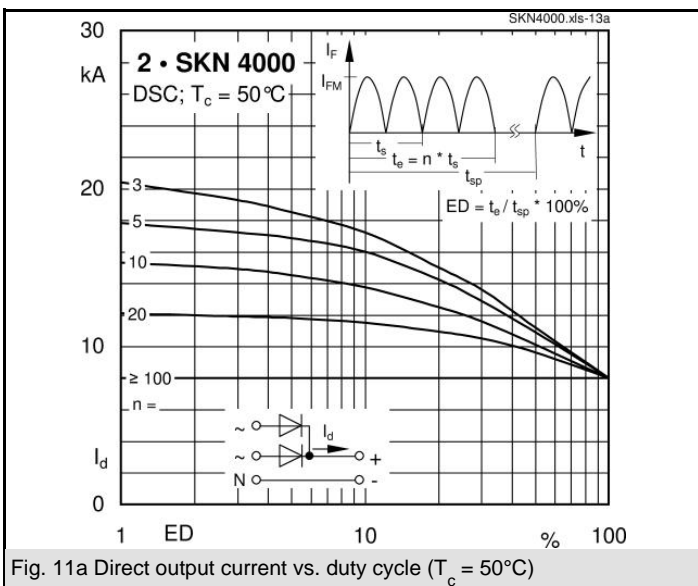
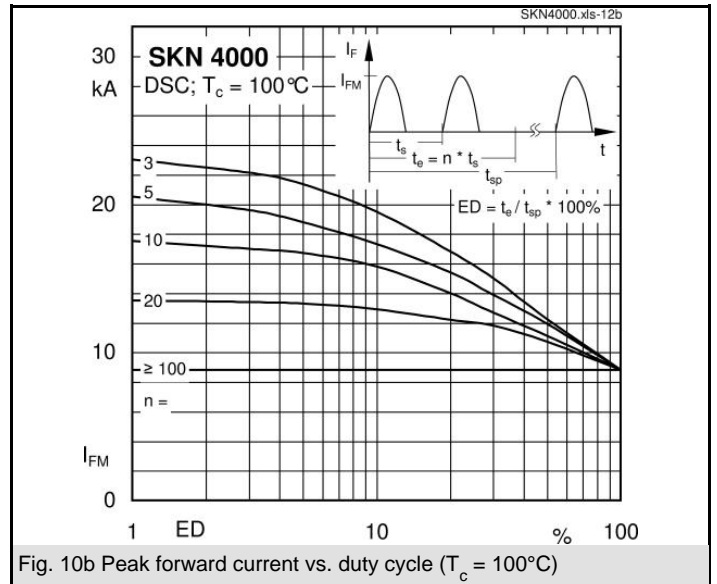
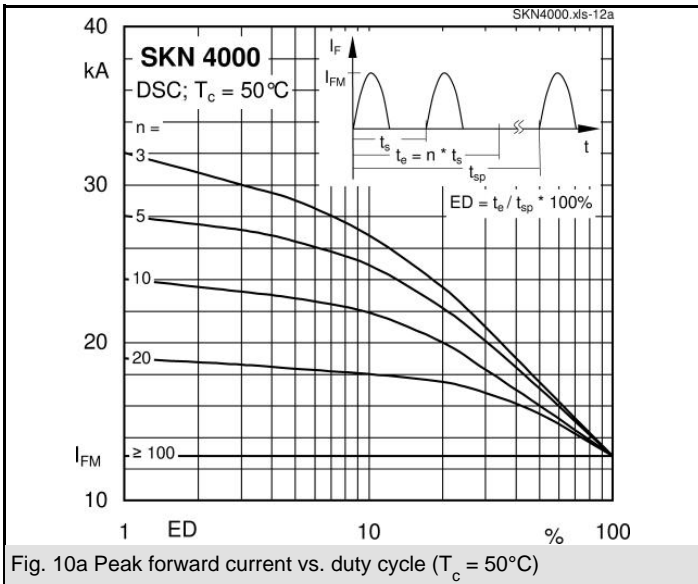
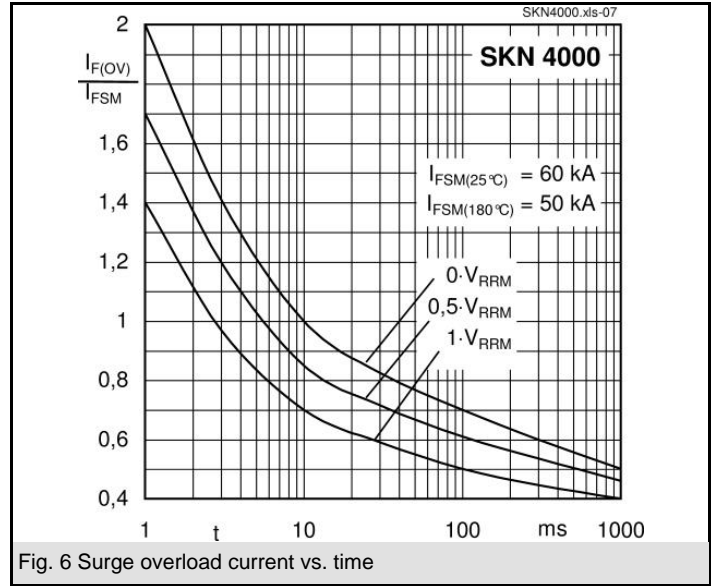
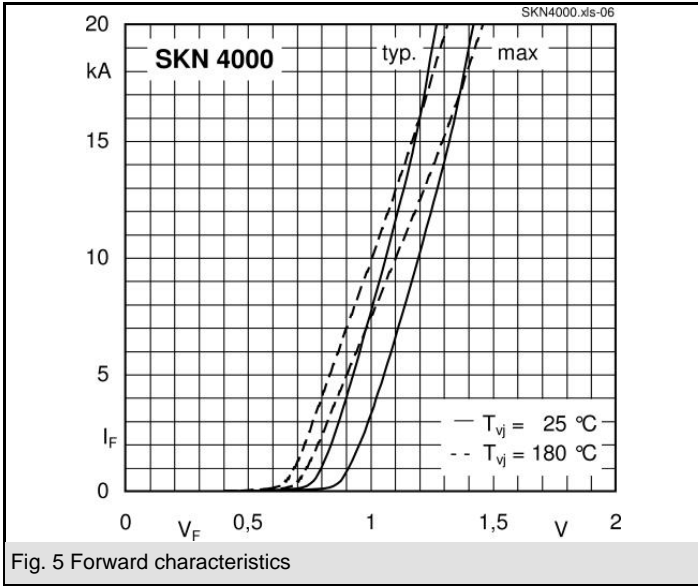

Dimensions in mm

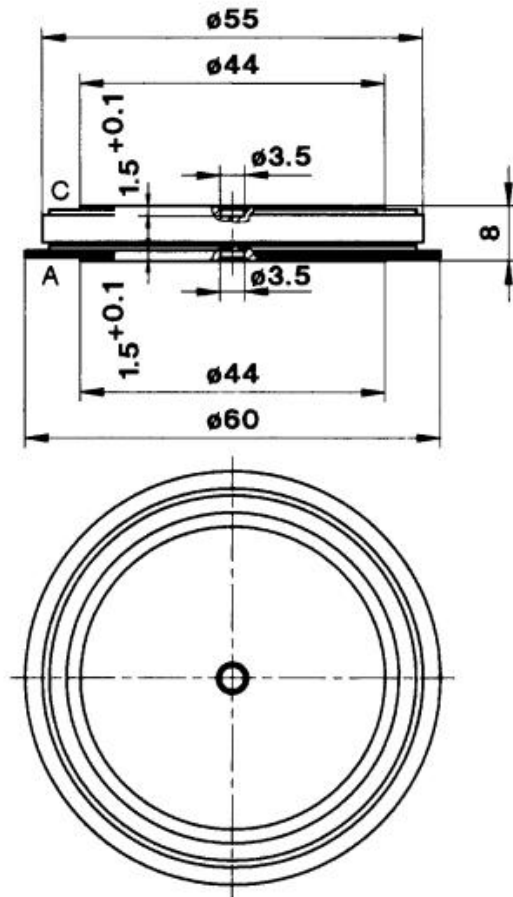

Case E 35

This technical information specifies semiconductor devices but promises no characteristics. No warranty or guarantee expressed or implied is made regarding delivery, performance or suitability.