

SKNa 402



Stud Diode

Avalanche Diode

SKNa 402

Publish Data

Features

- Avalanche type reverse characteristic
- Reverse voltages up to 5000 V
- Hermetic metal case with ceramic insulator and extra long creepage distances
- Threaded stud ISO M24 x 1,5
- Cooling via heatsinks
- SKN: Anode to stud

Typical Applications

- High voltage rectifier diode for traction and heavy duty applications
- Series connections for high voltage applications
- Non-controllable and half-controllable rectifiers
- Free-wheeling diodes

$V_{(BR)min}$	$I_{FRMS} = 700\text{ A}$ (maximum value for continuous operation)	C_{max}	R_{min}
V	$I_{FAV} = 400\text{ A}$ (sin. 180; $T_c = 88\text{ °C}$)	μF	Ω
3600	SKNa 402/36		
4000	SKNa 402/40		
4200	SKNa 402/42		
4500	SKNa 402/45		
4600	SKNa 402/46		
4800	SKNa 402/48		
5000	SKNa 402/50		

Symbol	Conditions	Values	Units
I_{FAV}	sin. 180 ; $T_c = 88\text{ (100) °C}$	400 (350)	A
I_D	P4/200; $T_a = 45\text{ °C}$; B2 / B6	455 / 655	A
	K 0,55F; $T_a = 35\text{ °C}$; B2 / B6	585 / 830	A
I_{FSM}	$T_{vj} = 25\text{ °C}$; 10 ms	7800	A
	$T_{vj} = 160\text{ °C}$; 10 ms	6600	A
i^2t	$T_{vj} = 25\text{ °C}$; 8,3 ... 10 ms	300000	A ² s
	$T_{vj} = 160\text{ °C}$; 8,3 ... 10 ms	140000	A ² s
V_F	$T_{vj} = 25\text{ °C}$; $I_F = 1200\text{ A}$	max. 1,85	V
$V_{(TO)}$	$T_{vj} = 150\text{ °C}$	max. 1	V
r_T	$T_{vj} = 150\text{ °C}$	max. 0,8	m Ω
I_{RD}	$T_{vj} = 25\text{ °C}$; $V_{RD} = V_{(BR)min}$	max. 3000	μA
	$T_{vj} = 160\text{ °C}$; $V_{RD} = V_{(BR)min}$	max. 60	mA
P_{RSM}	$T_{vj} = 160\text{ °C}$; $t_p = 10\text{ }\mu\text{s}$	90	kW
$R_{th(j-c)}$		0,1	K/W
$R_{th(c-s)}$		0,01	K/W
T_{vj}		- 40 ... + 160	$^{\circ}\text{C}$
T_{stg}		- 40 ... + 160	$^{\circ}\text{C}$
V_{isol}		-	V~
M_s	to heatsink	60	Nm
		530	lb.in.
a		5 * 9,81	m/s ²
m	approx.	550	g
Case		E 46	

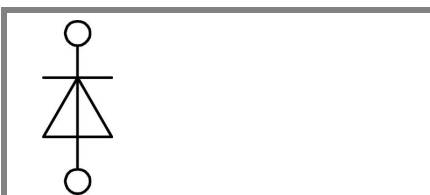

SKN

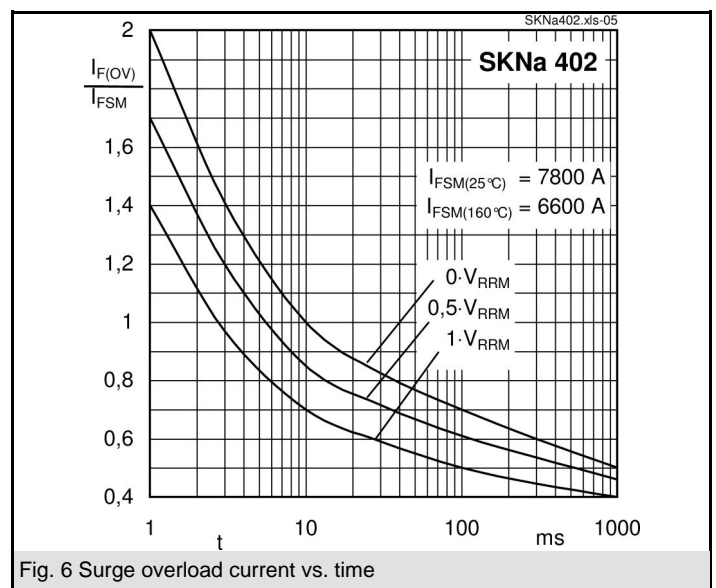
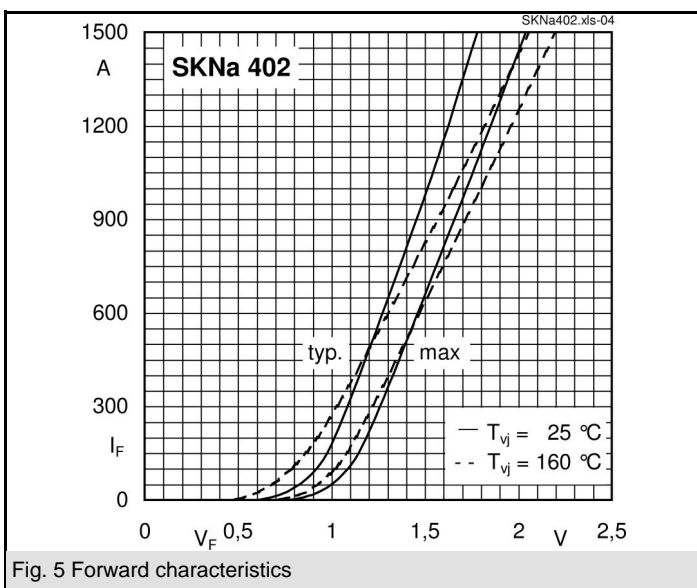
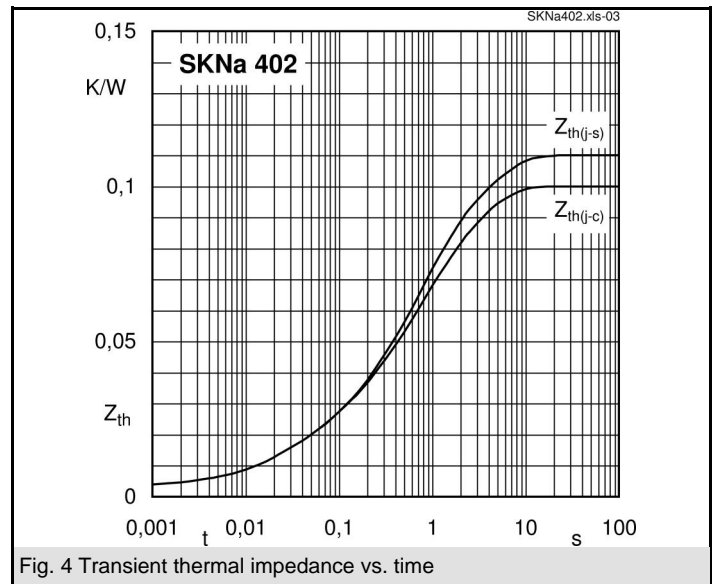
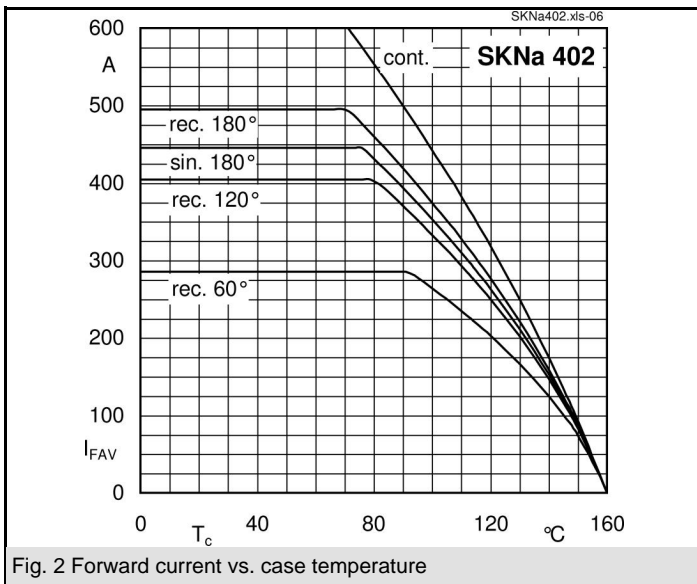
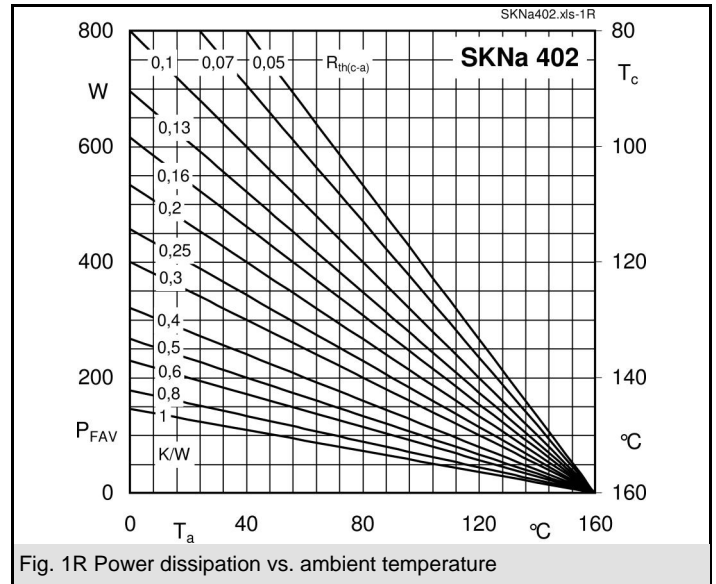
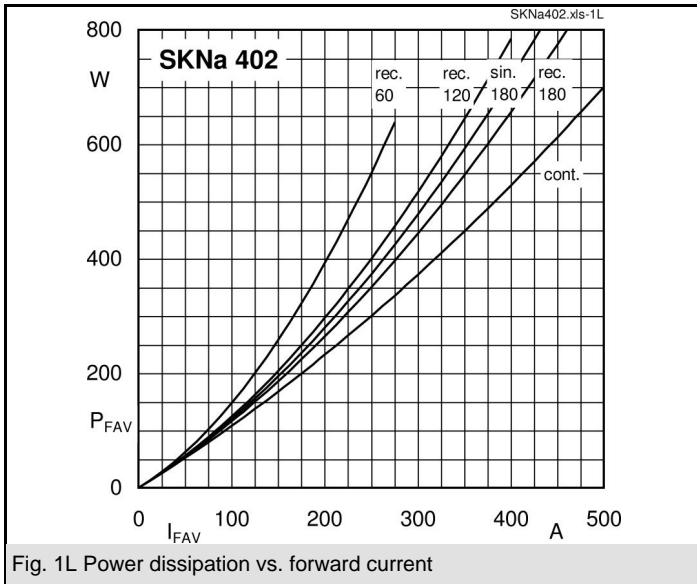

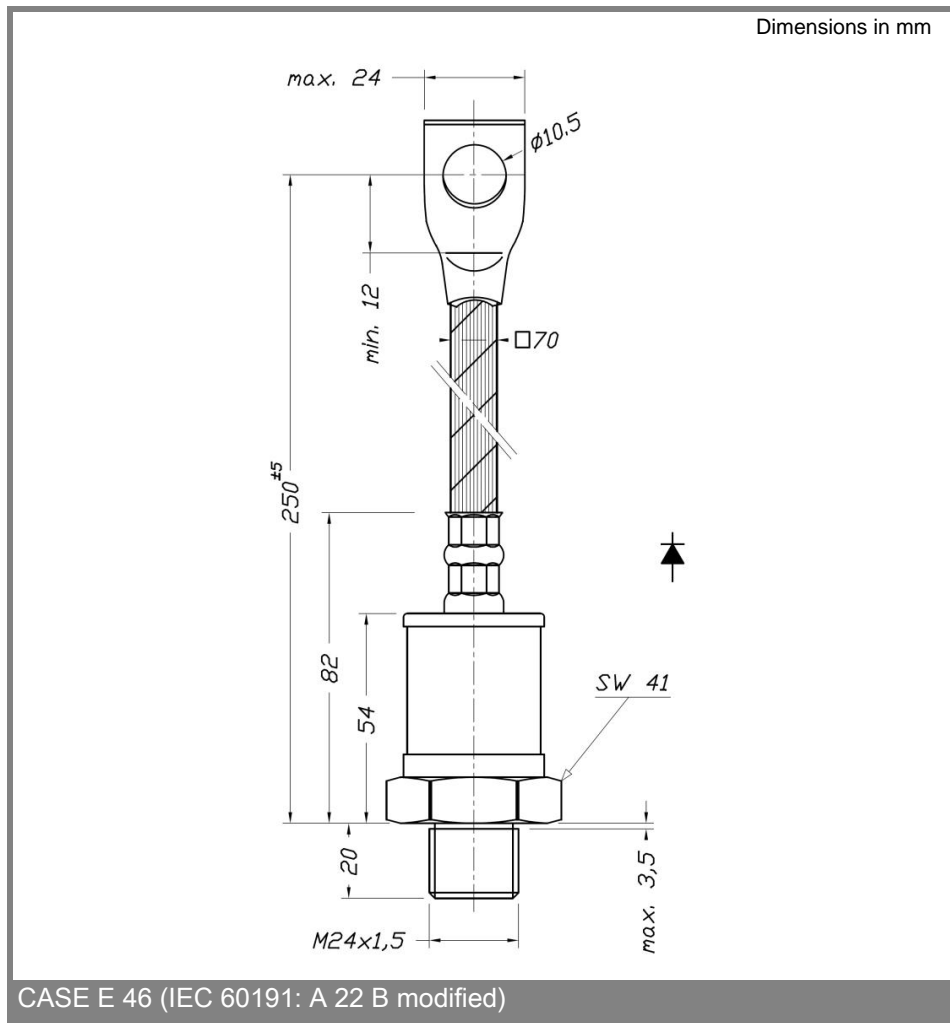

This technical information specifies semiconductor devices but promises no characteristics. No warranty or guarantee expressed or implied is made regarding delivery, performance or suitability.