

| | | | | |
|--------------------------------------|---|-------------------------------|-------------------------------|-------------------------------|
| V _{RSM} V _{RRM} | I _{FRMS} (maximum values for continuous operation) | | | |
| | 41 A | | | |
| V | I _{FAV} (sin. 180; T _{case} = 85 °C) | | | |
| | 26 A | | | |
| | t _{rr} = 150 ns | | t _{rr} = 250 ns | |
| | ∇ | ∇ | ∇ | ∇ |
| 400 | SKN 2F17/04 SKN 2F17/04UNF | SKR 2F17/04 SKR 2F17/04UNF | - - | - - |
| 600 | SKN 2F17/06 SKN 2F17/06UNF | SKR 2F17/06 SKR 2F17/06UNF | | |
| 800 | SKN 2F17/08 SKN 2F17/08UNF | SKR 2F17/08 SKR 2F17/08UNF | SKN 3F20/08 SKN 3F20/08UNF | SKR 3F20/08 SKR 3F20/08UNF |
| 1000 | SKN 2F17/10 SKN 2F17/10UNF | SKR 2F17/10 SKR 2F17/10UNF | SKN 3F20/10 SKN 3F20/10UNF | SKR 3F20/10 SKR 3F20/10UNF |
| 1200 | - - | - - | SKN 3F20/12 SKN 3F20/12UNF | SKR 3F20/12 SKR 3F20/12UNF |

Fast Recovery Rectifier Diodes

SKN 2 F 17 SKR 2 F 17
SKN 3 F 20 SKR 3 F 20



| Symbol | Conditions | SKN 2 F 17 SKR 2 F 17 | SKN 3 F 20 SKR 3 F 20 | Units |
|-------------------|---|--------------------------|--------------------------|--------------------------------------|
| I _{FAV} | sin.180; T _{case} = 85 °C; f=5000 Hz = 104 °C = 113 °C sin.180/rec.120; T _{amb} = 5 °C; K9 K5 | 26 | 26 | A |
| | | - | 20 | A |
| | | 17 | - | A |
| | | | 6,7 /6,5 10/9,5 | A |
| I _{FSM} | T _{vj} = 25 °C; 10 ms T _{vj} = 150 °C; 10 ms | 450 380 | 375 310 | A A |
| i ² t | T _{vj} = 25 °C; 8,3 ... 10 ms T _{vj} = 150 °C; 8,3 ... 10 ms | 1000 720 | 700 480 | A ² s A ² s |
| Q _{rr} | } T _{vj} = 130 °C; I _F = 50 A; - $\frac{dI_F}{dt} = 15 \frac{A}{\mu s}$; V _R = 30 V | 1,0 | 1,5 | μC |
| I _{RM} | | 4,5 | 5 | A |
| I _R | T _{vj} = 25 °C; V _R = V _{RRM} T _{vj} = 130 °C; V _R = V _{RRM} | max. 0,2 max. 16 | max. 0,2 max. 20 | mA mA |
| t _{rr} | T _{vj} = 25 °C } I _F = I _R = 1 A T _{vj} = 130 °C } | max. 150 typ. 300 | max. 250 typ. 500 | ns ns |
| V _F | T _{vj} = 25 °C; I _F = 50 A | max. 2,15 | | V |
| V _(TO) | T _{vj} = 130 °C | 1,3 | | V |
| r _T | T _{vj} = 130 °C | 12 | | mΩ |
| R _{thjc} | | 1,2 | | °C/W |
| R _{thch} | | 0,5 | | °C/W |
| T _{vj} | | - 40 ... + 150 | | °C |
| T _{stg} | | - 55 ... + 150 | | °C |
| M | SI units | 1,5 | | Nm |
| | US units | 13 | | lb.in. |
| a | | 5 · 9,81 | | m/s ² |
| w | | 7 | | g |
| Case | | E7 | | |

Features

- Small recovered charge
- Soft recovery
- Up to 1200 V reverse voltage
- Hermetic metal cases with glass insulators
- Threaded studs ISO M5 or 10-32 UNF
- **SKN**: anode to stud
- **SKR**: cathode to stud

Typical Applications

- Inverse diodes for power transistors, GTO thyristors asymmetric thyristors
- SMPS, inverters, choppers
- For severe ambient conditions

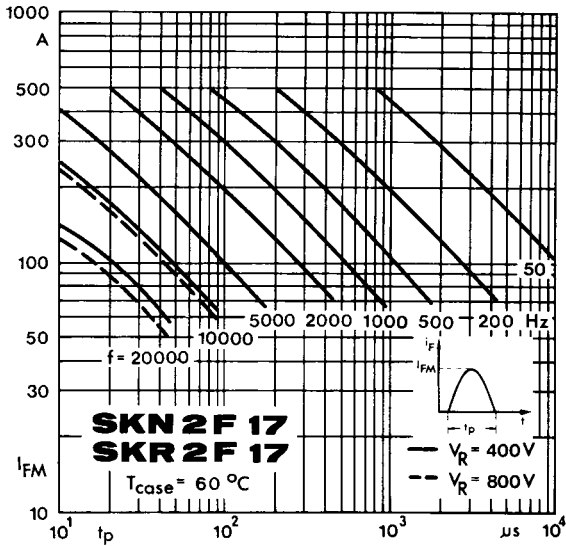

Fig. 1 a Rated sinusoidal peak forward current

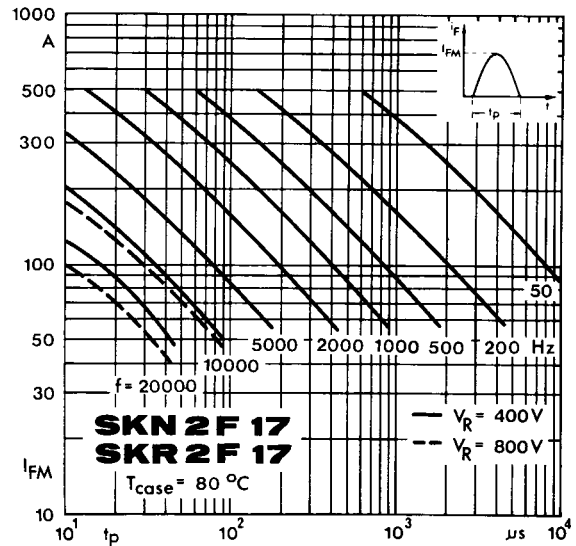

Fig. 1 b Rated sinusoidal peak forward current

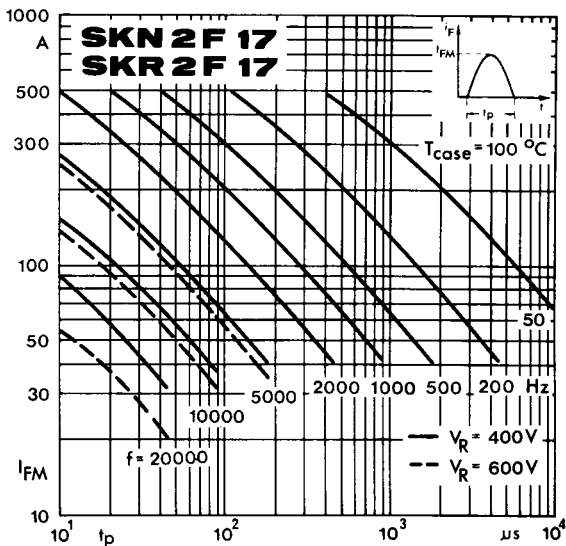

Fig. 1 c Rated sinusoidal peak forward current

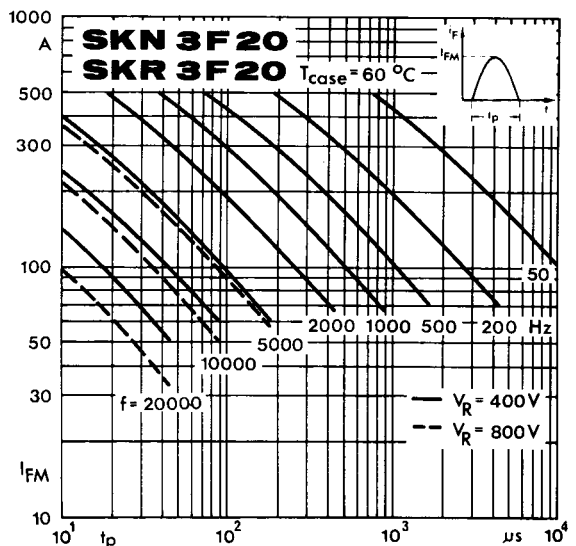

Fig. 1 d Rated sinusoidal peak forward current

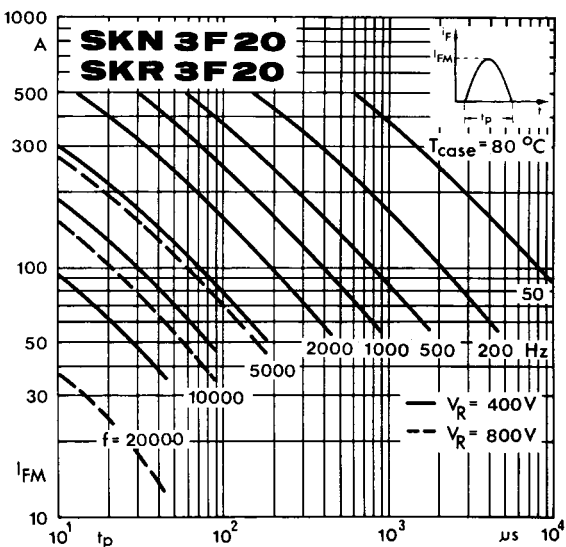

Fig. 1 e Rated sinusoidal peak forward current

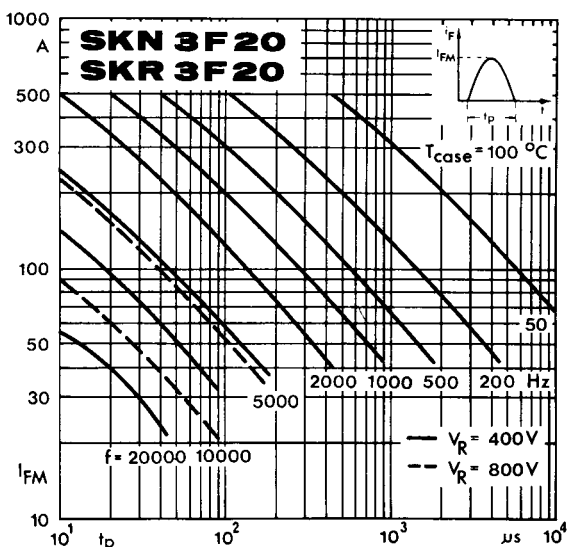

Fig. 1 f Rated sinusoidal peak forward current

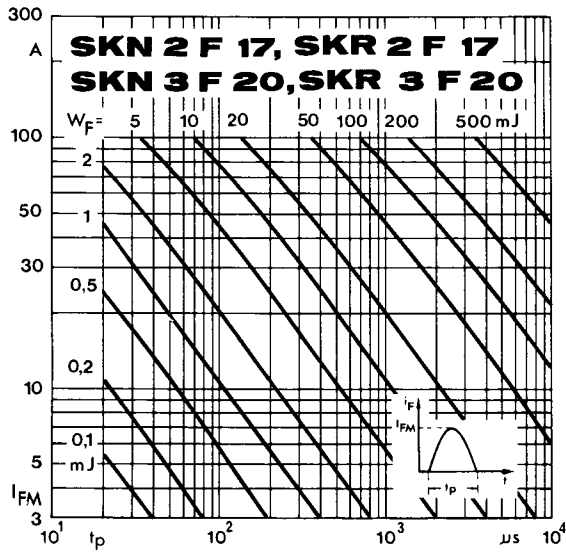

Fig. 2 Forward energy dissipation, sinusoidal

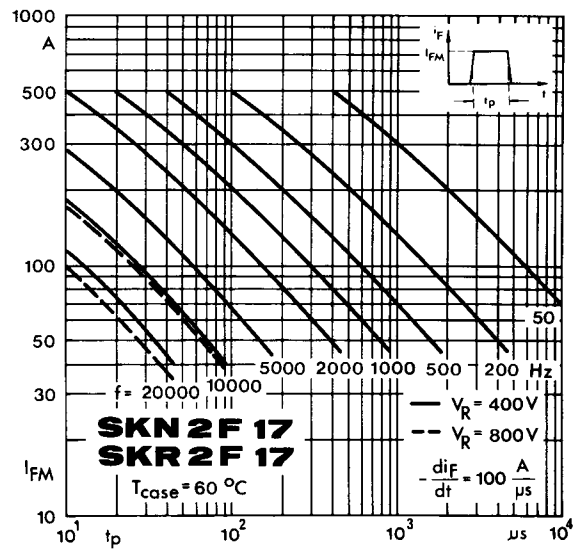

Fig. 3 a Rated rectangular peak forward current

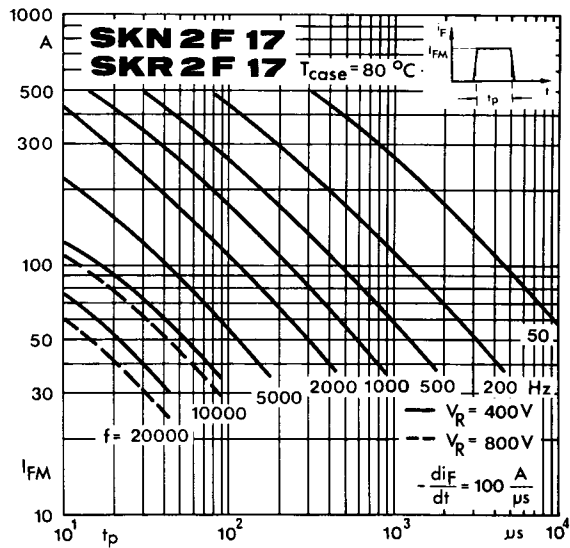

Fig. 3 b Rated rectangular peak forward current

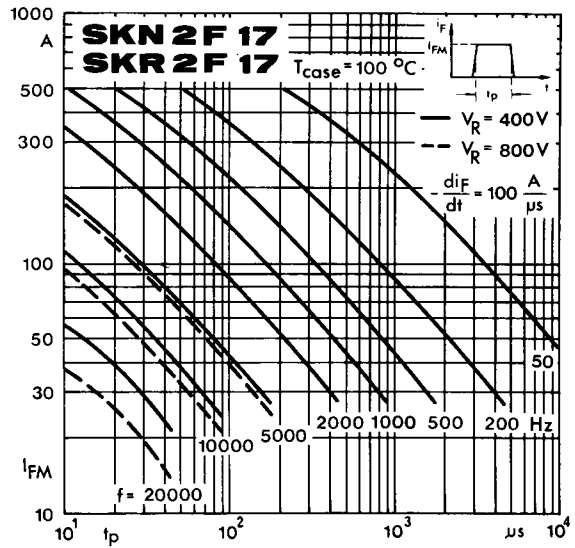

Fig. 3 c Rated rectangular peak forward current

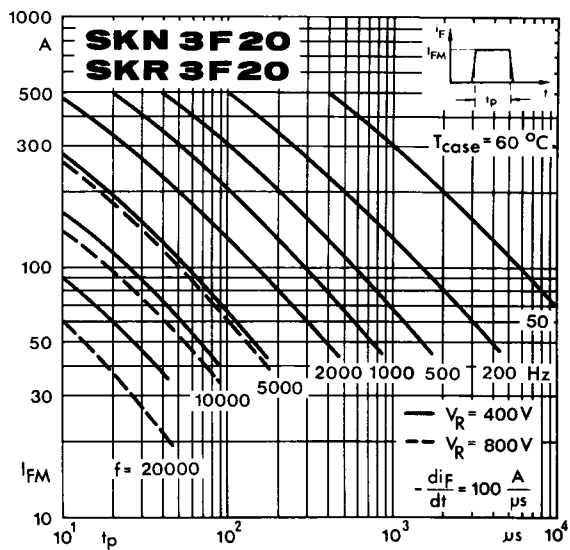

Fig. 3 d Rated rectangular peak forward current

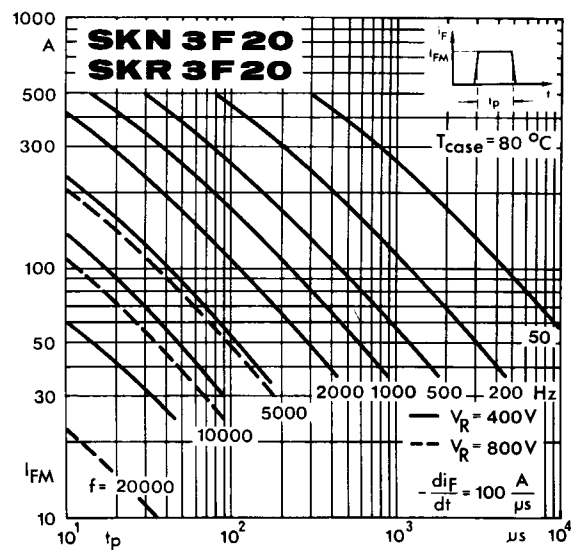

Fig. 3 e Rated rectangular peak forward current

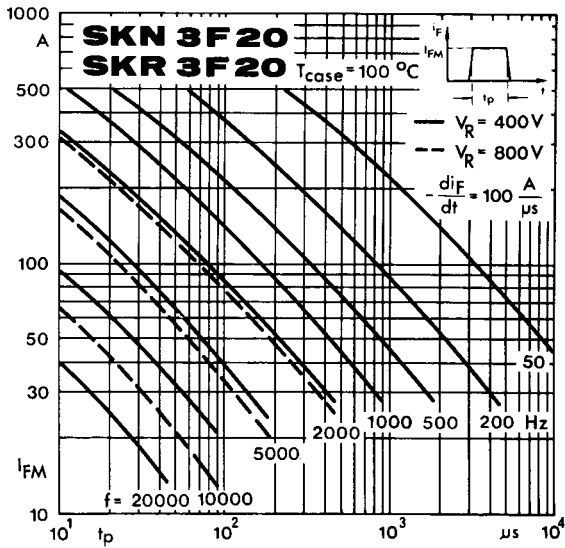

Fig. 3 f Rated rectangular peak forward current

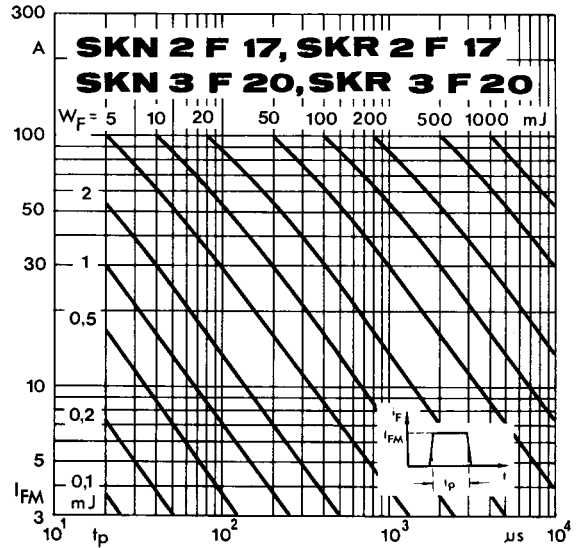

Fig. 4 Forward energy dissipation, rectangular

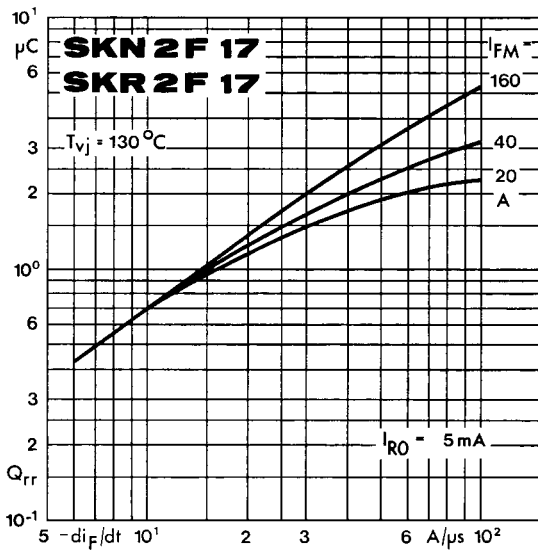

Fig. 5 a Recovered charge

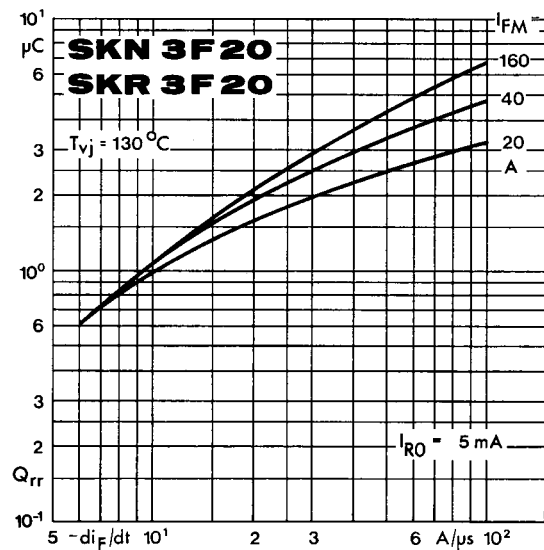

Fig. 5 b Recovered charge

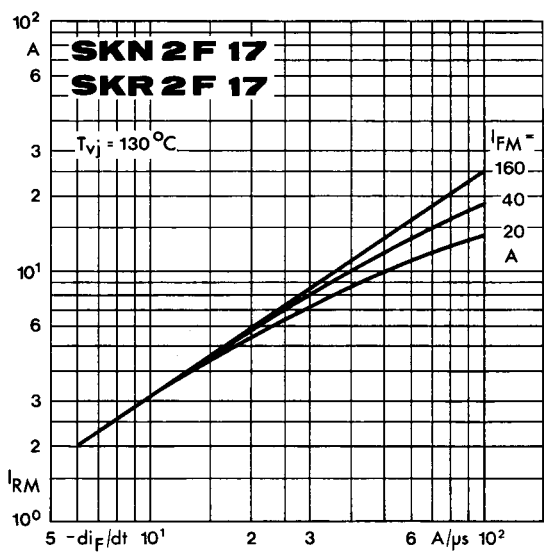

Fig. 6 a Peak reverse recovery current

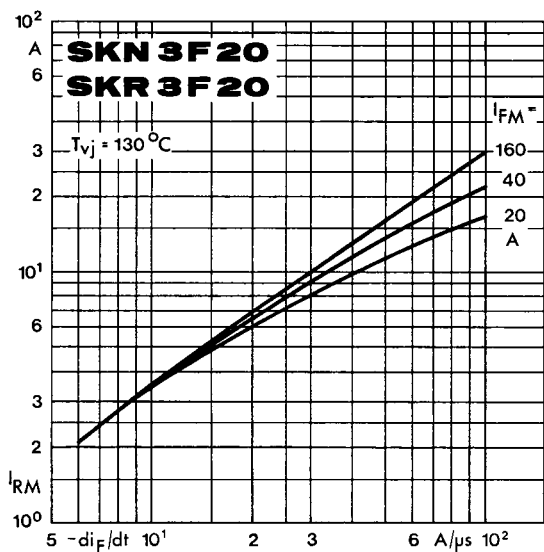

Fig. 6 b Peak reverse recovery current

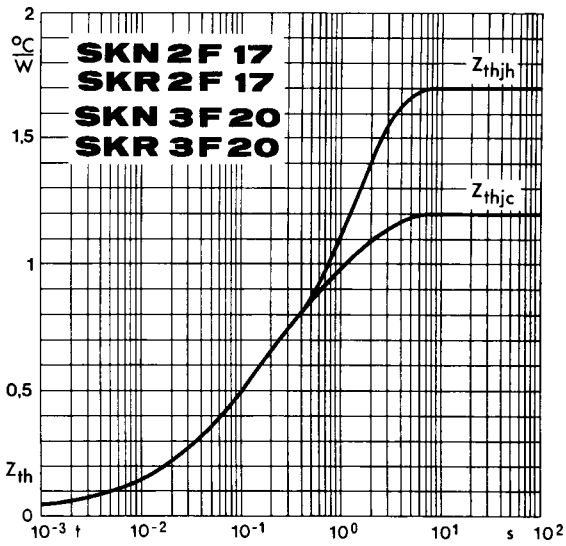

Fig. 7 Transient thermal impedance

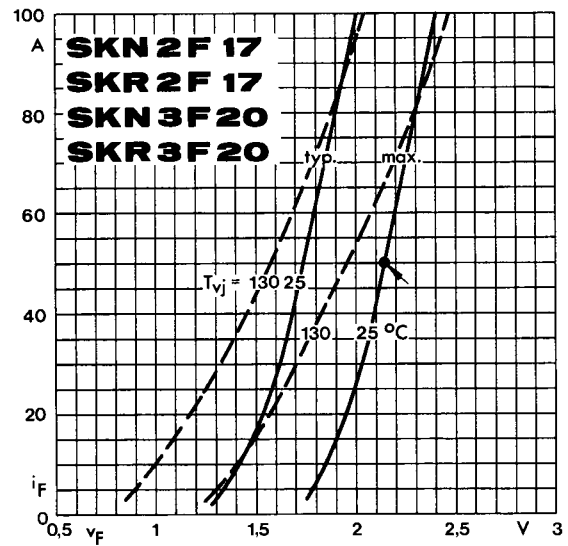

Fig. 8 Forward characteristics

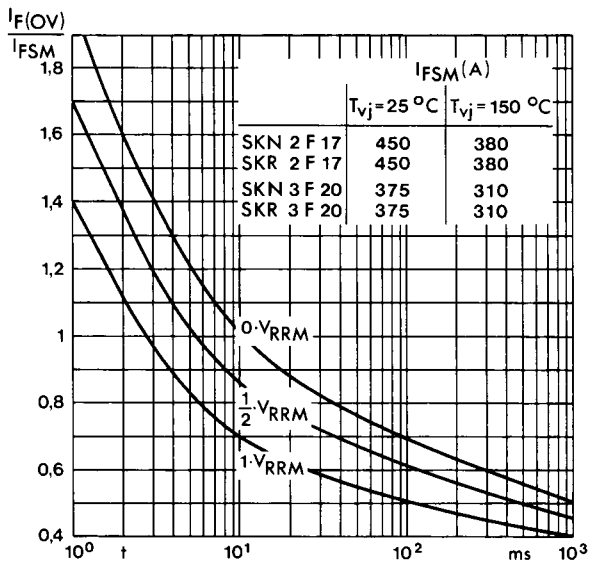
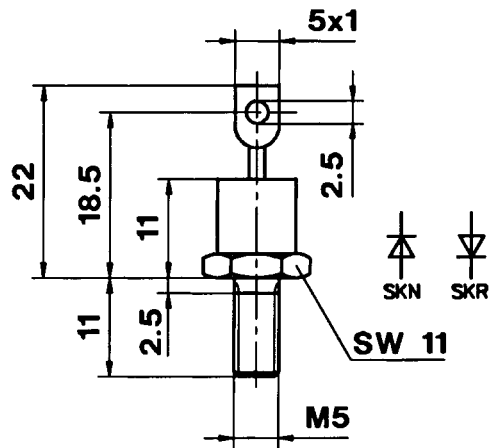

Fig 9 Rated surge overload current

SKN 2 F 17
 SKR 2 F 17
 SKN 3 F 20
 SKR 3 F 20

Case E 7

IEC-Publ. 191-2: A 3 M
 DIN 41 885: 101 C 2
 BS 3934: SO-10
 JEDEC: DO-203 AA (DO-4) metric



Dimensions in mm

SKN 2 F 17 ... UNF
 SKR 2 F 17 ... UNF
 SKN 3 F 20 ... UNF
 SKR 3 F 20 ... UNF

Case E 7 UNF

IEC-Publ. 191-2: A 3 U
 BS 3934: SO-10
 JEDEC: DO-203 AA (DO-4)

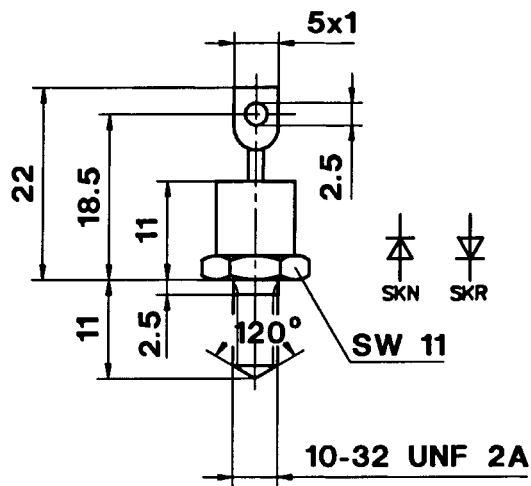

Dimensions in mm