

V <sub>RSM</sub>	V <sub>RRM</sub> V <sub>DRM</sub>	$\left(\frac{dv}{dt}\right)_{cr}$	I <sub>TRMS</sub> (maximum values for continuous operation)	
			3000 A	5000 A
V	V	V/μs	I <sub>TAV</sub> (sin. 180; T <sub>case</sub> = . . . ; DSC)	
			1500 A (55 °C)	2450 A (55 °C)
2300	2200	1000	–	<b>SKT 2000/22 E</b>
2700	2600	1000	<b>SKT 1400/26 E</b>	<b>SKT 2000/26 E</b>
2900	2800	1000	<b>SKT 1400/28 E</b>	<b>SKT 2000/28 E</b>
3300	3200	1000	<b>SKT 1400/32 E</b>	–
3700	3600	1000	<b>SKT 1400/36 E</b>	–

## Thyristors

### SKT 1400 SKT 2000



Symbol	Conditions	SKT 1400	SKT 2000
I <sub>TAV</sub>	sin. 180; (T <sub>case</sub> = ...); DSC	1400 A (62 °C)	2000 A (72 °C)
I <sub>TSM</sub>	T <sub>vj</sub> = 25 °C T <sub>vj</sub> = 125 °C	29 000 A 25 000 A	45 000 A 39 000 A
i <sup>2</sup> t	T <sub>vj</sub> = 25 °C T <sub>vj</sub> = 125 °C	4 200 000 A <sup>2</sup> s 3 125 000 A <sup>2</sup> s	10 125 000 A <sup>2</sup> s 7 600 000 A <sup>2</sup> s
t <sub>gd</sub> t <sub>gr</sub> (di/dt) <sub>cr</sub> I <sub>H</sub> I <sub>L</sub> t <sub>q</sub>	T <sub>vj</sub> = 25 °C; I <sub>G</sub> = 1 A; di <sub>G</sub> /dt = 1 A/μs V <sub>D</sub> = 0,67 · V <sub>DRM</sub> f = 50 . . . 60 Hz T <sub>vj</sub> = 25 °C; typ./max. T <sub>vj</sub> = 25 °C; typ./max. T <sub>vj</sub> = 125 °C; typ.	typ. 1 μs typ. 2 μs 150 A/μs 500 mA/1 A 2 A/5 A 200 ... 300 μs	
V <sub>T</sub> V <sub>T(TO)</sub> r <sub>T</sub> I <sub>DD</sub> , I <sub>RD</sub>	T <sub>vj</sub> = 25 °C; I <sub>T</sub> = 3000 A; max. T <sub>vj</sub> = 125 °C T <sub>vj</sub> = 125 °C T <sub>vj</sub> = 125 °C; V <sub>DD</sub> = V <sub>DRM</sub> ; V <sub>RD</sub> = V <sub>RRM</sub>	2,1 V 1,04 V 0,35 mΩ 100 mA	1,8 V 1,09 V 0,236 mΩ 100 mA
V <sub>GT</sub> I <sub>GT</sub> V <sub>GD</sub> I <sub>GD</sub>	T <sub>vj</sub> = 25 °C T <sub>vj</sub> = 25 °C T <sub>vj</sub> = 125 °C T <sub>vj</sub> = 125 °C	3 V 300 mA 0,25 V 10 mA	
R <sub>thjc</sub> R <sub>thch</sub> T <sub>vj</sub> T <sub>stg</sub>	cont. DSC sin. 180; DSC/SSC rec. 120; DSC/SSC DCS/SSC	} °C/W 0,018 0,0185/0,039 0,020/0,041 0,003/0,006 – 40 ... +125 °C – 40 ... +130 °C	
F w	SI units US units	27 ... 34 kN 6000 ... 7600 lbs.	37 ... 47 kN 8000 ... 10000 lbs.
Case		B 19	B 20

### Features

- Hermetic metal cases with ceramic insulators
- Amplifying gates
- Capsule packages for double sided cooling
- Shallow design with single sided cooling
- Off-state and reverse voltages up to 3600 V

### Typical Applications

- DC motor control (e. g. for machine tools)
- Controlled rectifiers (e. g. for battery charging)
- AC controllers (e. g. for temperature control)
- Soft starters for AC motors

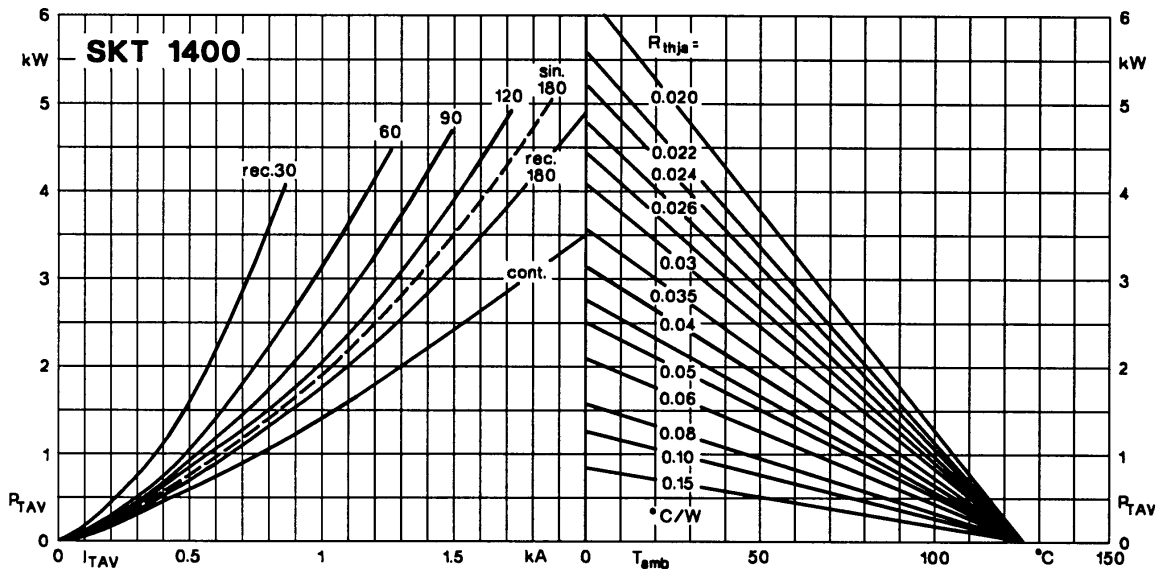

Fig. 1 a Power dissipation vs. on-state current and ambient temperature

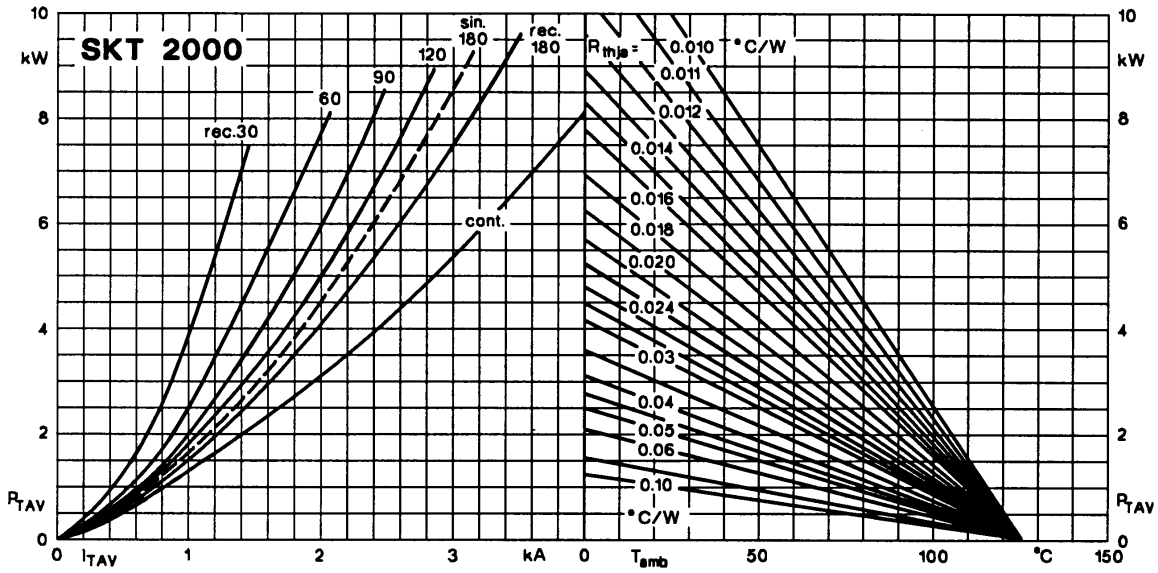

Fig. 1 b Power dissipation vs. on-state current and ambient temperature

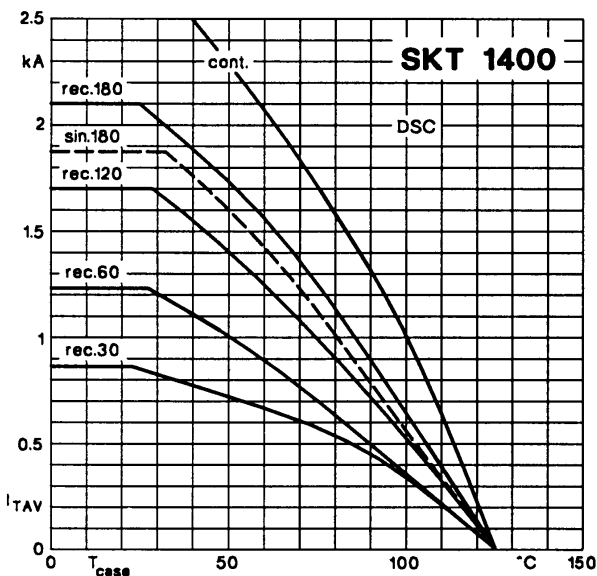

Fig. 2 a Rated on-state current vs. case temperature

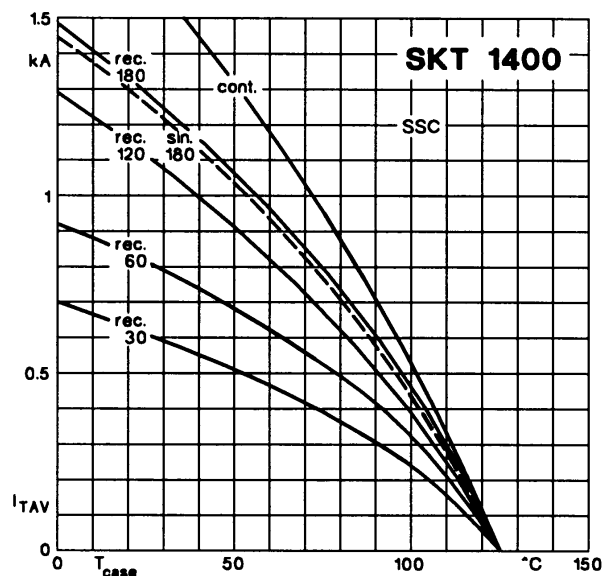

Fig. 2 b Rated on-state current vs. case temperature

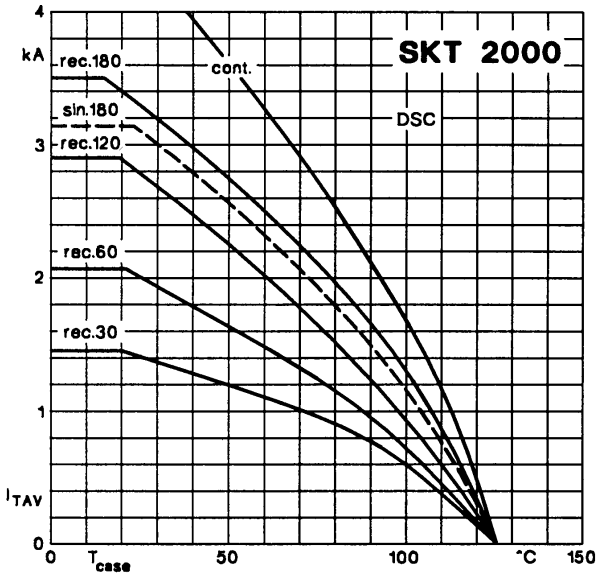

Fig. 2 c Rated on-state current vs. case temperature

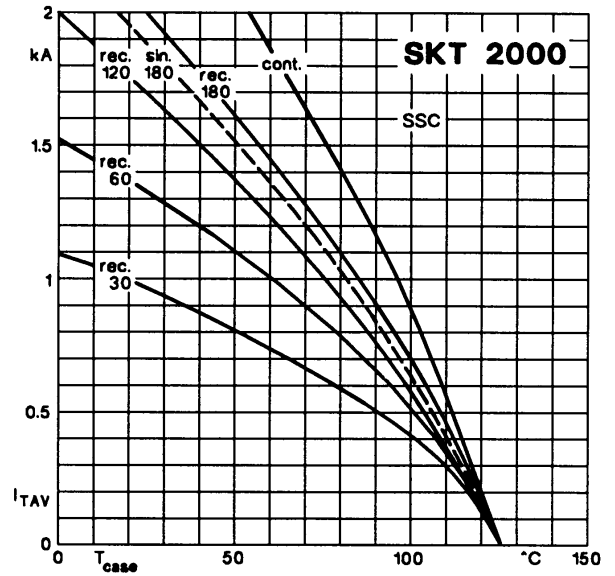

Fig. 2 d Rated on-state current vs. case temperature

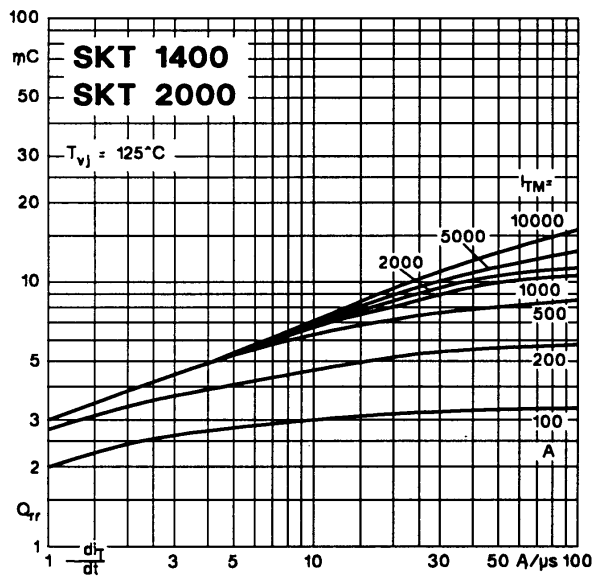

Fig. 3 Recovered charge vs. current decrease

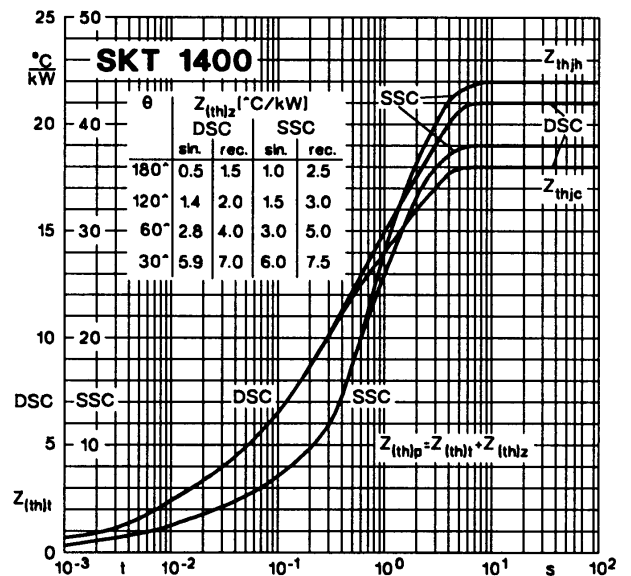

Fig. 4 a Transient thermal impedance vs. time

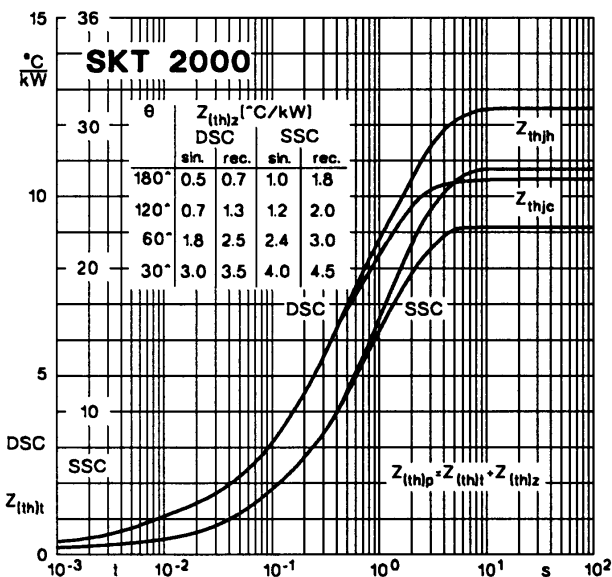

Fig. 4 b Transient thermal impedance vs. time

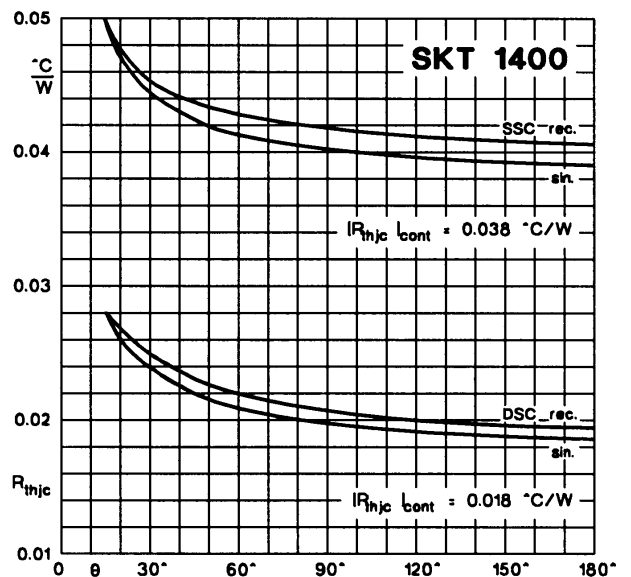

Fig. 5 a Thermal resistance vs. conduction angle

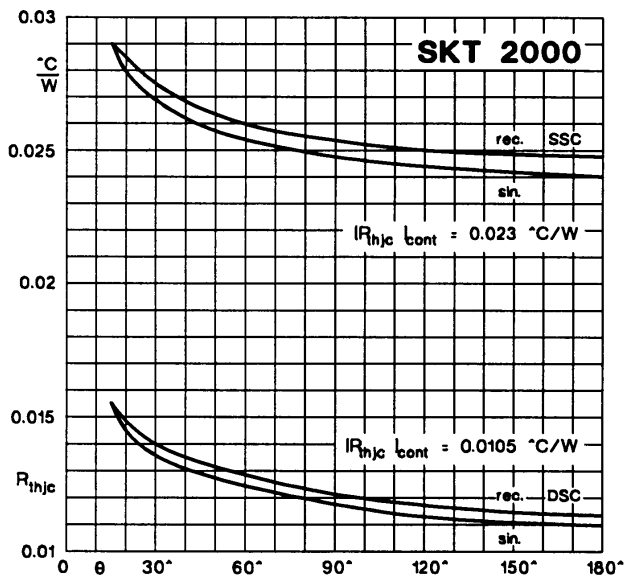

Fig. 5 b Thermal resistance vs. conduction angle

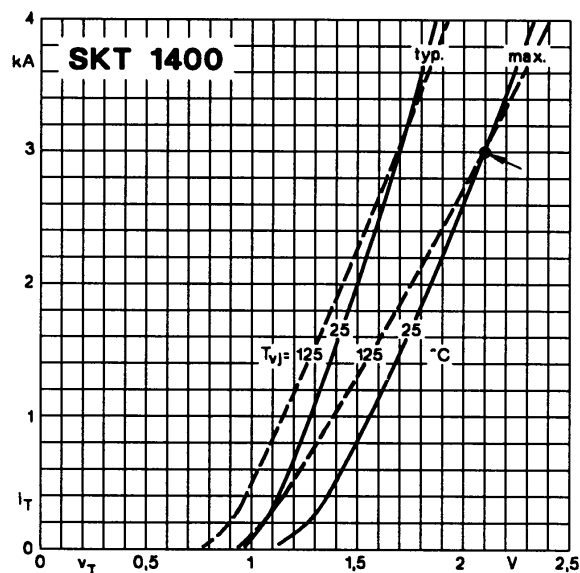

Fig. 6 a On-state characteristics

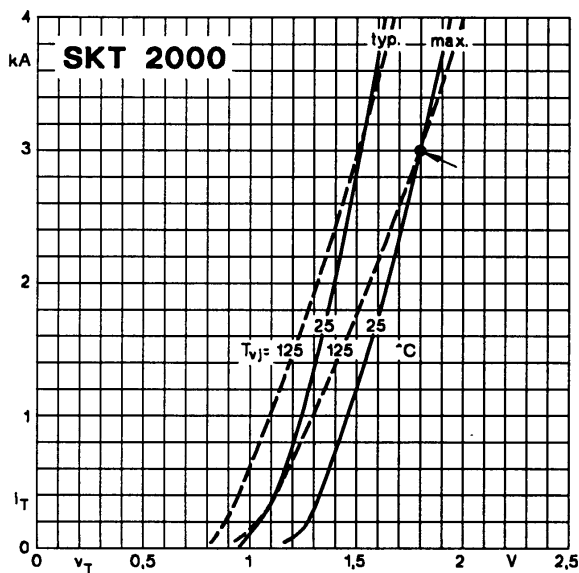

Fig. 6 b On-state characteristics

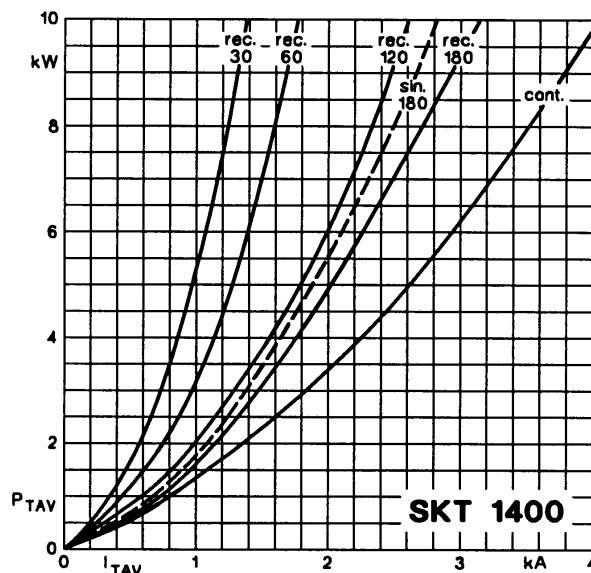

Fig. 7 a Power dissipation vs. on-state current

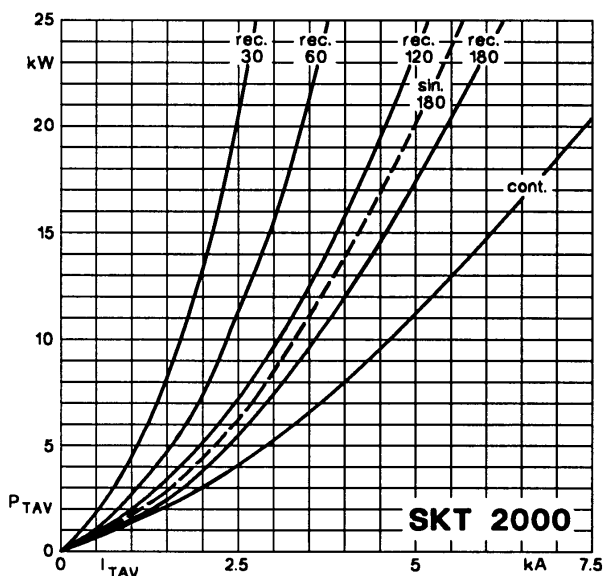

Fig. 7 b Power dissipation vs. on-state current

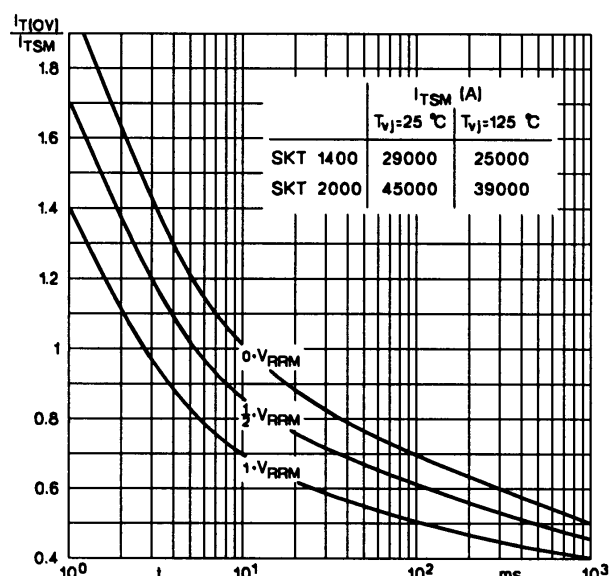

Fig. 8 Surge overload current vs. time

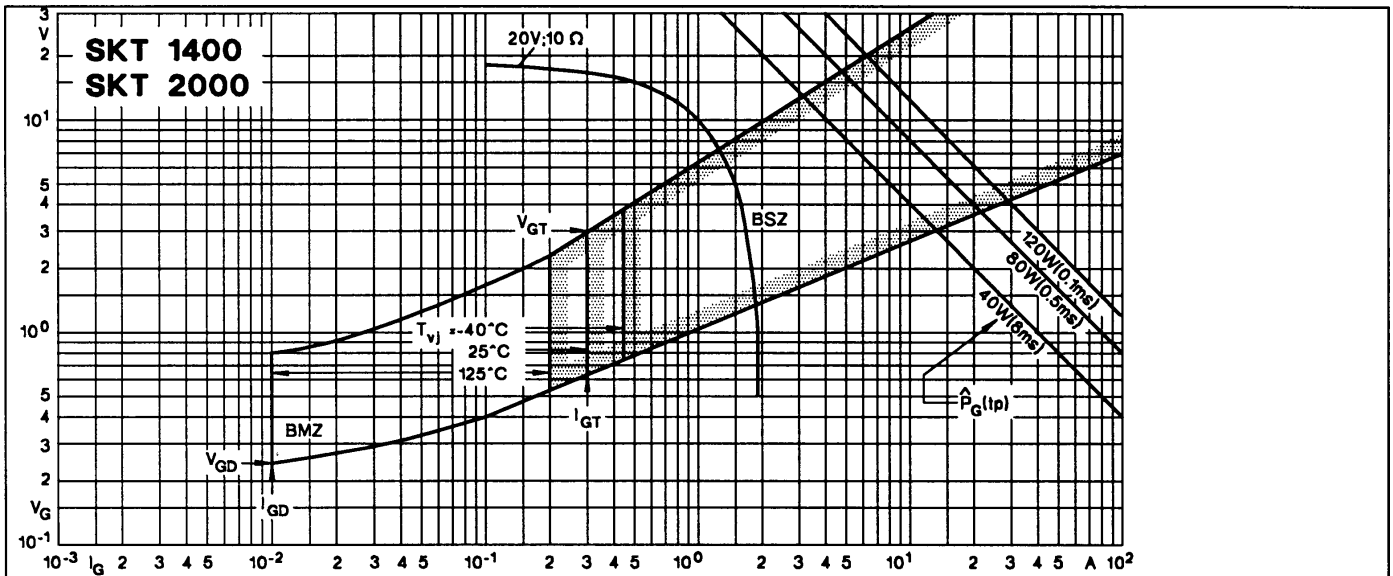
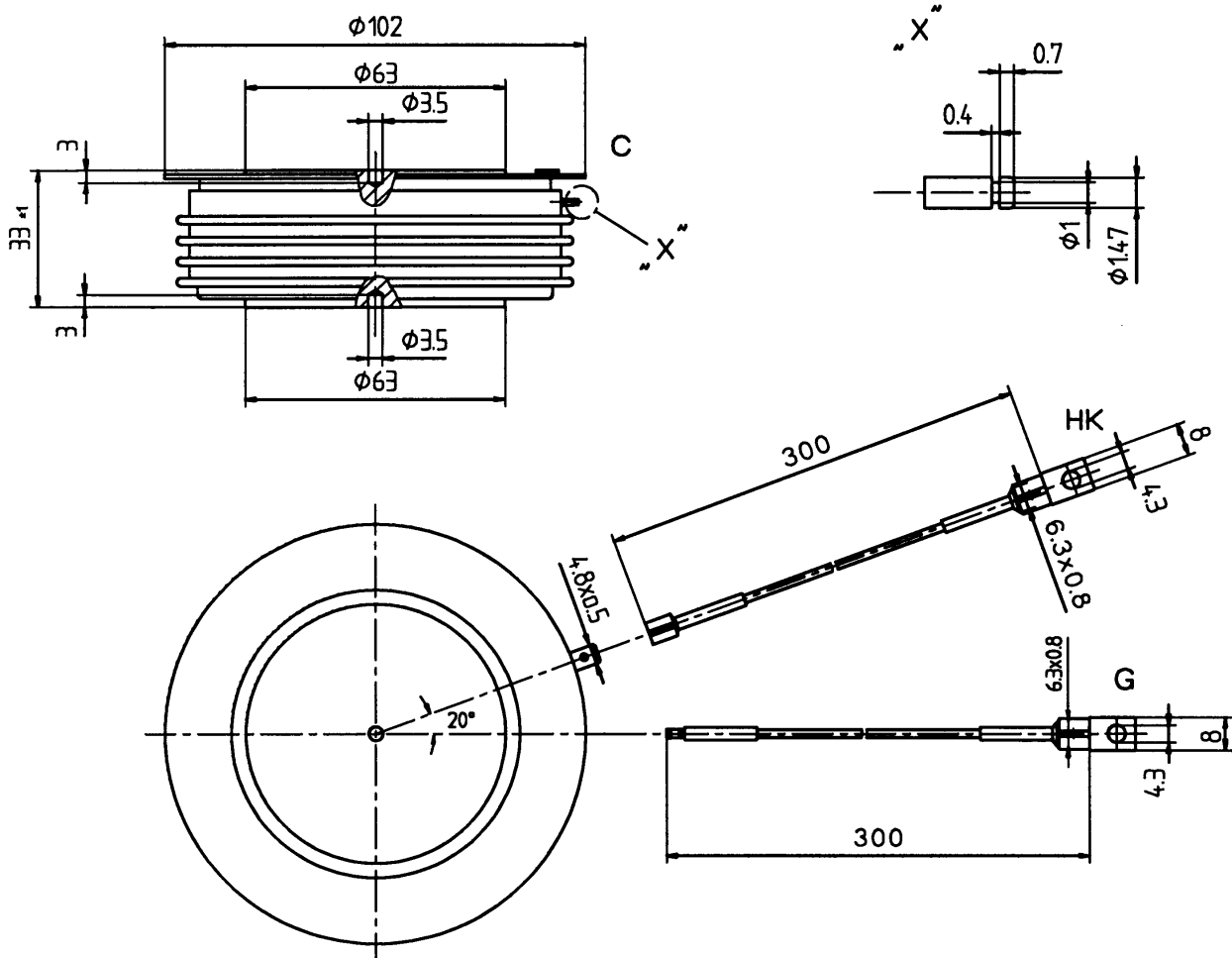

Fig. 9 Gate trigger characteristics

## SKT 1400

Case B 19



- C: Cathode terminal
- A: Anode terminal
- G: Gate terminal (yellow sleeve)
- HK: Auxiliary cathode terminal (red sleeve)

Dimensions in mm

**SKT 2000**

Case B 20

JEDEC: TO-200 AF

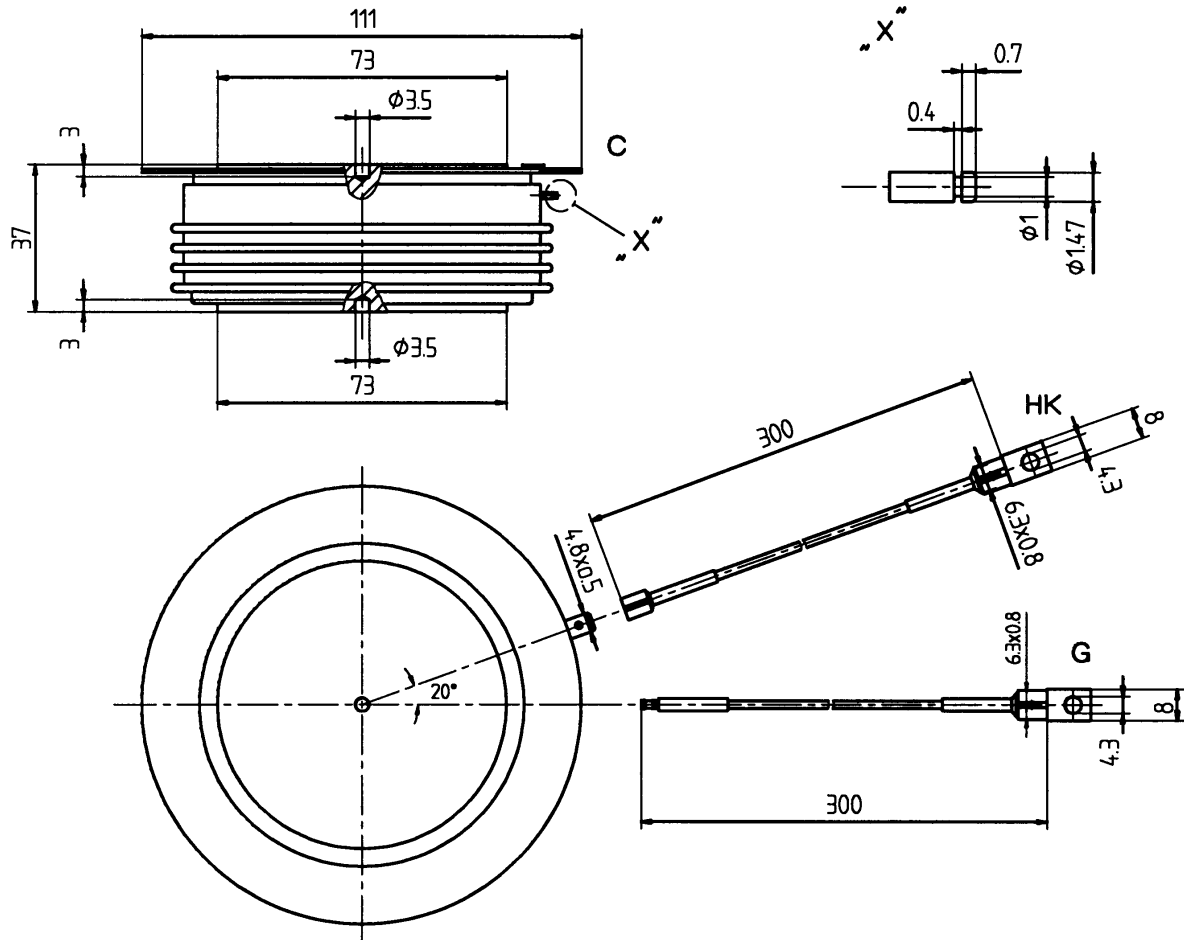

- C: Cathode terminal
- A: Anode terminal
- G: Gate terminal (yellow sleeve)
- HK: Auxiliary cathode terminal (red sleeve)

Dimensions in mm