

SKT 491, SKT 551

V_{RSM}	V_{RRM} V_{DRM}	$(dv/dt)_{cr}$	I_{TRMS} (maximum values for continuous operation)	
			1000 A	1200 A
V	V	V/ μ s	I_{TAV} (sin. 180; $T_{case} = \dots$; DSC)	
			640 A (58 °C)	765 A (61 °C)
500	400	1000	SKT 491/04 E	–
900	800	1000	SKT 491/08 E	SKT 551/08 E
1300	1200	1000	SKT 491/12 E	SKT 551/12 E
1500	1400	1000	SKT 491/14 E	SKT 551/14 E
1700	1600	1000	SKT 491/16 E	SKT 551/16 E
1900	1800	1000	SKT 491/18 E	SKT 551/18 E

Thyristors

SKT 491 SKT 551



Symbol	Conditions	SKT 491	SKT 551	Units
I_{TAV}	sin. 180; ($T_{case} = \dots$); DSC	490 (80)	550 (85)	A °C
I_{TSM}	$T_{vj} = 25\text{ °C}$	8 000	9 000	A
i^2t	$T_{vj} = 125\text{ °C}$	7 000	8 000	A
	$T_{vj} = 25\text{ °C}$	320 000	405 000	A ² s
t_{gd}	$T_{vj} = 25\text{ °C}$ $I_G = 1\text{ A}$ $di_G/dt = 1\text{ A}/\mu\text{s}$	typ. 1		μs
		typ. 1		μs
t_{gr}	$V_D = 0,67 \cdot V_{DRM}$	125		A/ μs
$(di/dt)_{cr}$	f = 50 ... 60 Hz	150 / 500		mA
I_H	$T_{vj} = 25\text{ °C}$; typ./max.	0,5 / 2		A
I_L	$T_{vj} = 25\text{ °C}$; $R_G = 33\ \Omega$; typ./max.	50 ... 150		μs
t_q	$T_{vj} = 125\text{ °C}$; typ.			
V_T	$T_{vj} = 25\text{ °C}$; $I_T = 1500\text{ A}$; max.	2,1	1,65	V
$V_{T(TO)}$	$T_{vj} = 125\text{ °C}$	1,1	0,925	V
r_T	$T_{vj} = 125\text{ °C}$	0,7	0,45	m Ω
I_{DD} ; I_{RD}	$T_{vj} = 125\text{ °C}$; $V_{RD} = V_{RRM}$ $V_{DD} = V_{DRM}$	50		mA
V_{GT}	$T_{vj} = 25\text{ °C}$	3		V
I_{GT}	$T_{vj} = 25\text{ °C}$	250		mA
V_{GD}	$T_{vj} = 125\text{ °C}$	0,25		V
I_{GD}	$T_{vj} = 125\text{ °C}$	10		mA
R_{thjc}	cont.;	0,045		°C/W
	sin. 180; DSC/SSC	0,047 / 0,100		°C/W
	rec. 120; DSC/SSC	0,054 / 0,113		°C/W
	DSC/SSC	0,012 / 0,024		°C/W
R_{thch}		– 40 ... + 125		°C
T_{vj}		– 40 ... + 130		°C
T_{stg}				
F	SI units	5,2 ... 8		kN
	US units	1200 ... 1800		lbs.
w		105		g
Case	→ page B 3 – 32	B 11		

Features

- Hermetic metal/ceramic cases
- Capsule packages for double sided cooling
- Shallow design with single sided cooling
- International standard cases
- Off-state and reverse voltages up to 1800 V
- Amplifying gate

Typical Applications

- DC motor control (e. g. for machine tools)
- Controlled rectifiers (e. g. for battery charging)
- AC controllers (e. g. for temperature control)

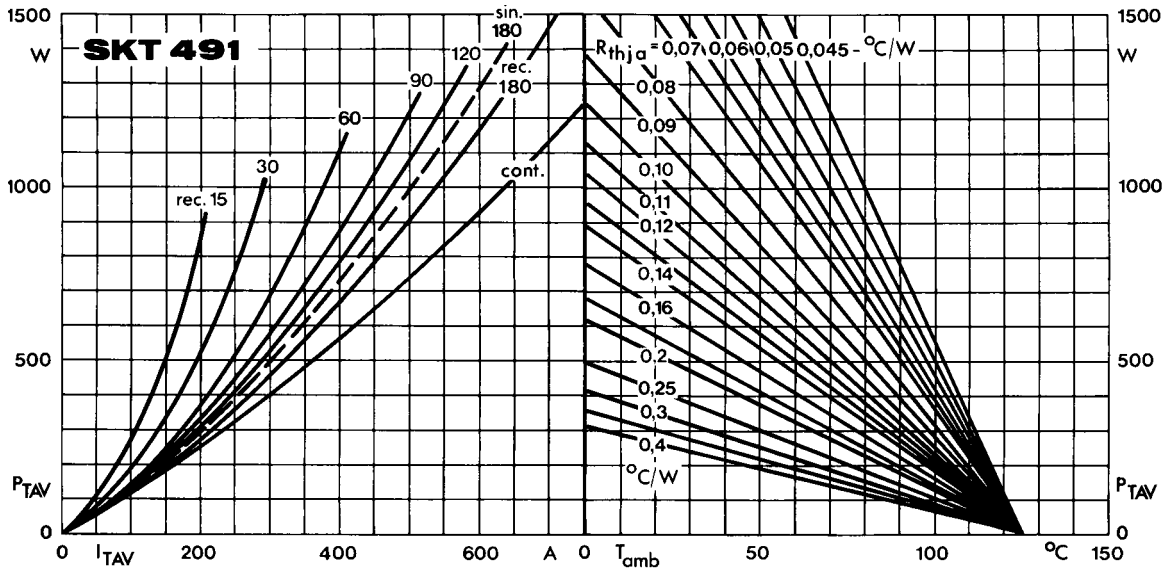

Fig. 1 a Power dissipation vs. on-state current and ambient temperature

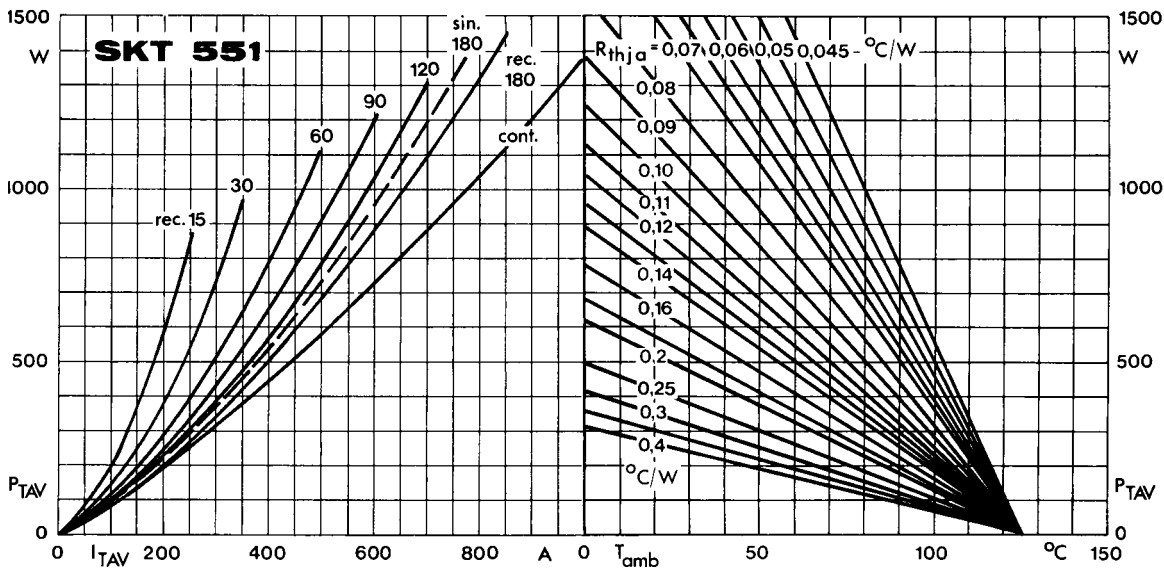

Fig. 1 b Power dissipation vs. on-state current and ambient temperature

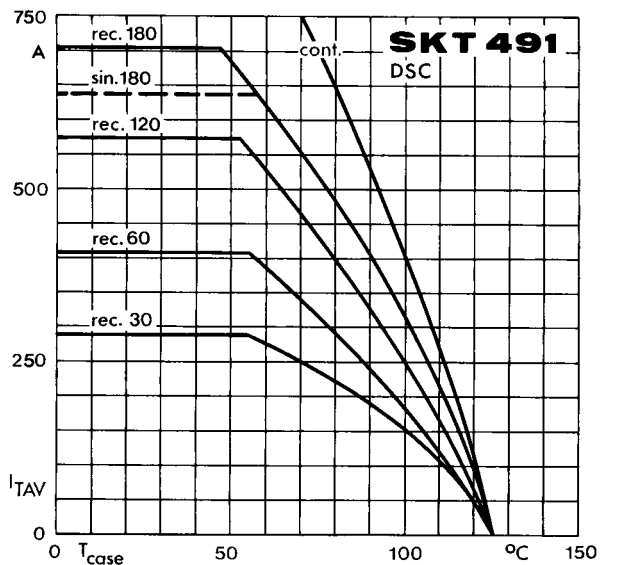

Fig. 2 a Rated on-state current vs. case temperature

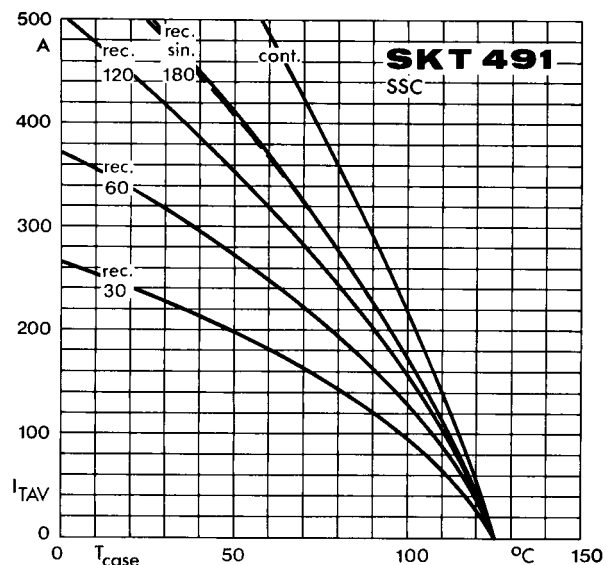

Fig. 2 b Rated on-state current vs. case temperature

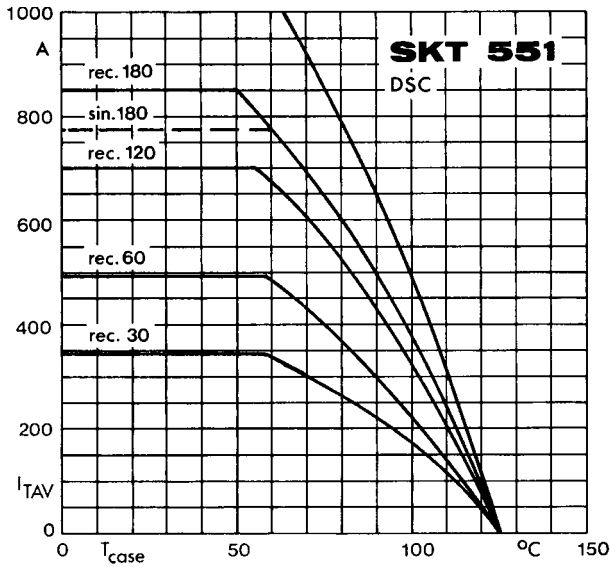

Fig. 2 c Rated on-state current vs. case temperature

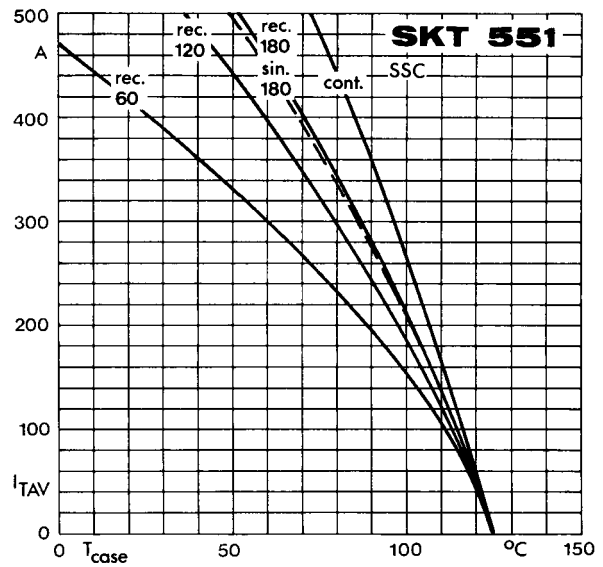

Fig. 2 d Rated on-state current vs. case temperature

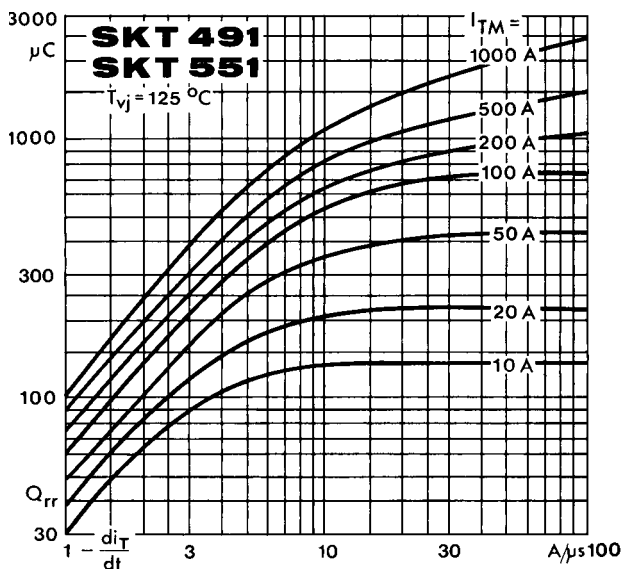

Fig. 3 Recovered charge vs. current decrease

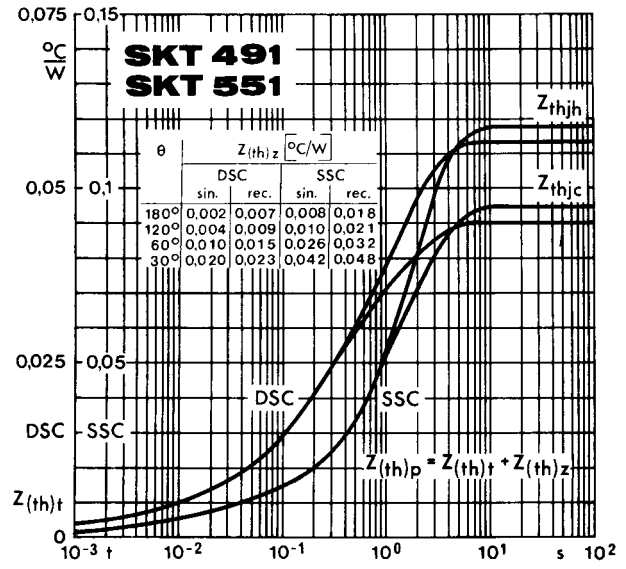

Fig. 4 Transient thermal impedance vs. time

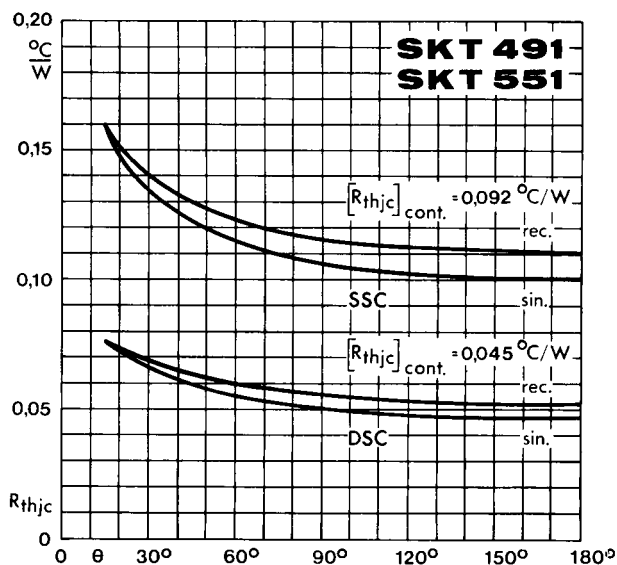

Fig. 5 Thermal resistance vs. conduction angle

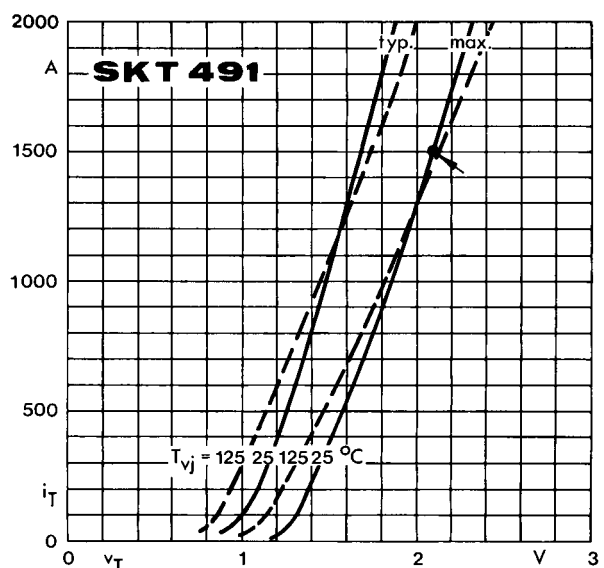

Fig. 6 a On-state characteristics

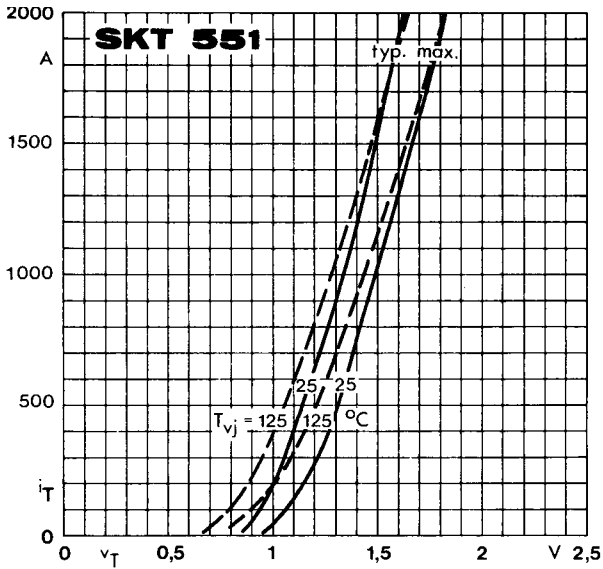

Fig. 6 b On-state characteristics

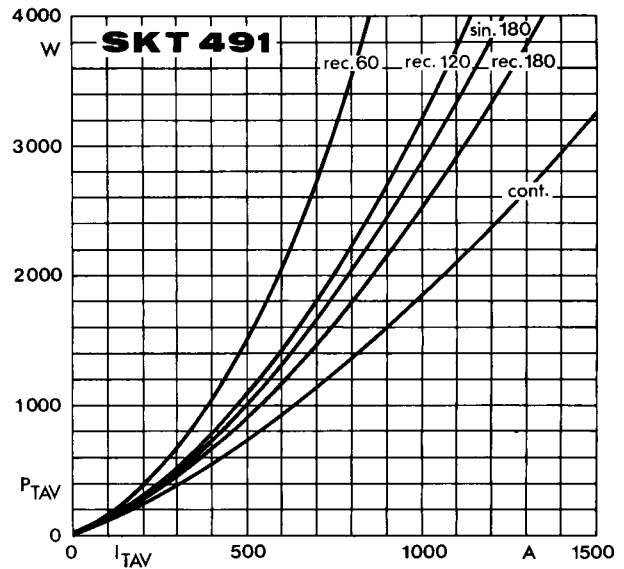

Fig. 7 a Power dissipation vs. on-state current

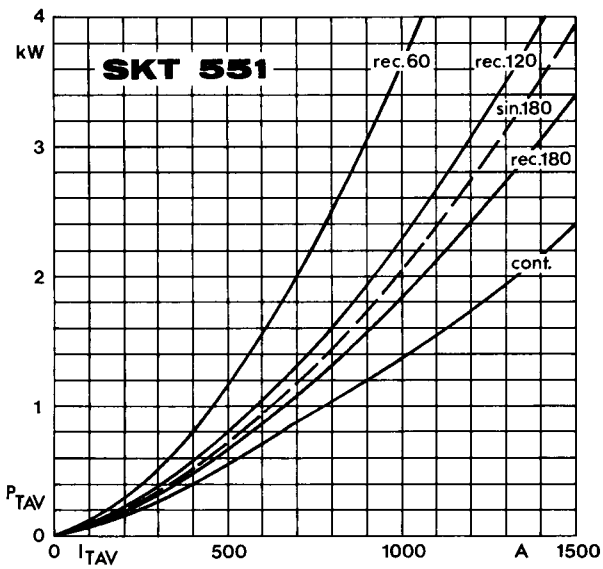

Fig. 7 b Power dissipation vs. on-state current

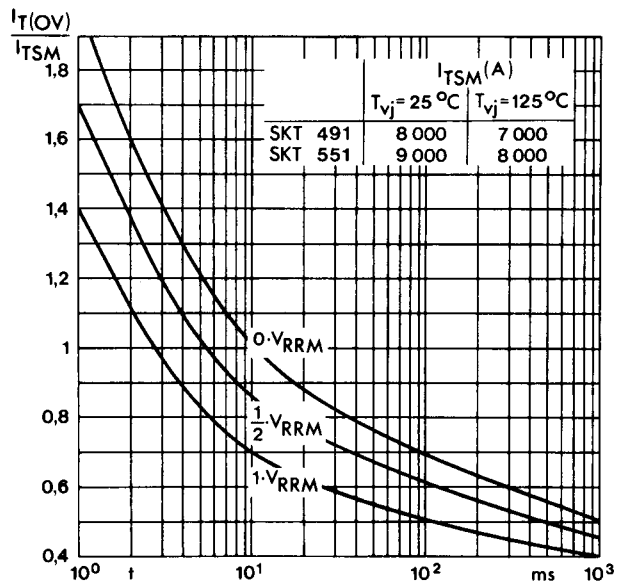

Fig. 8 Surge overload current vs. time

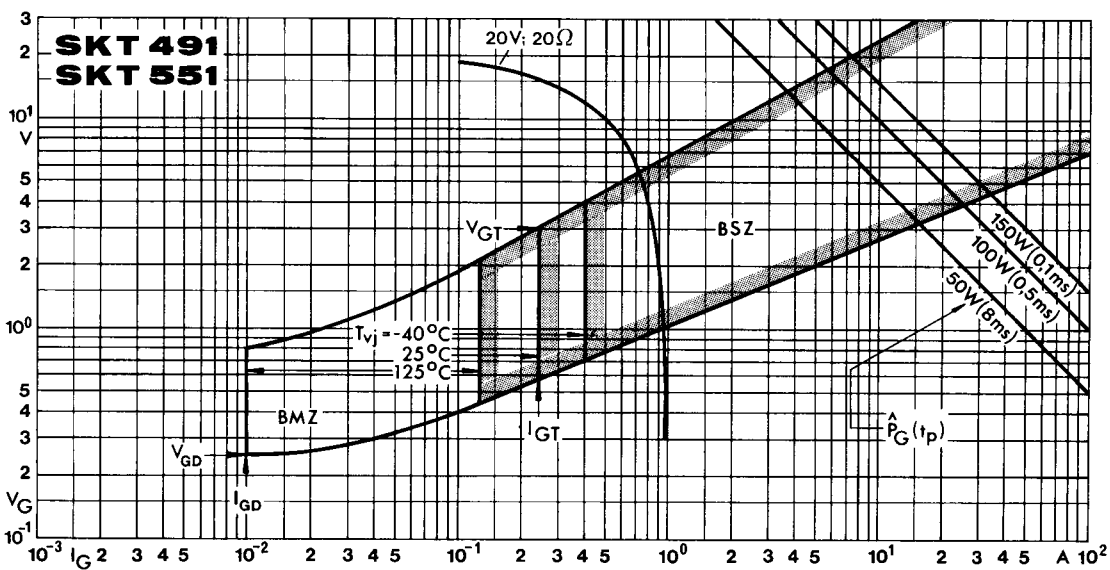
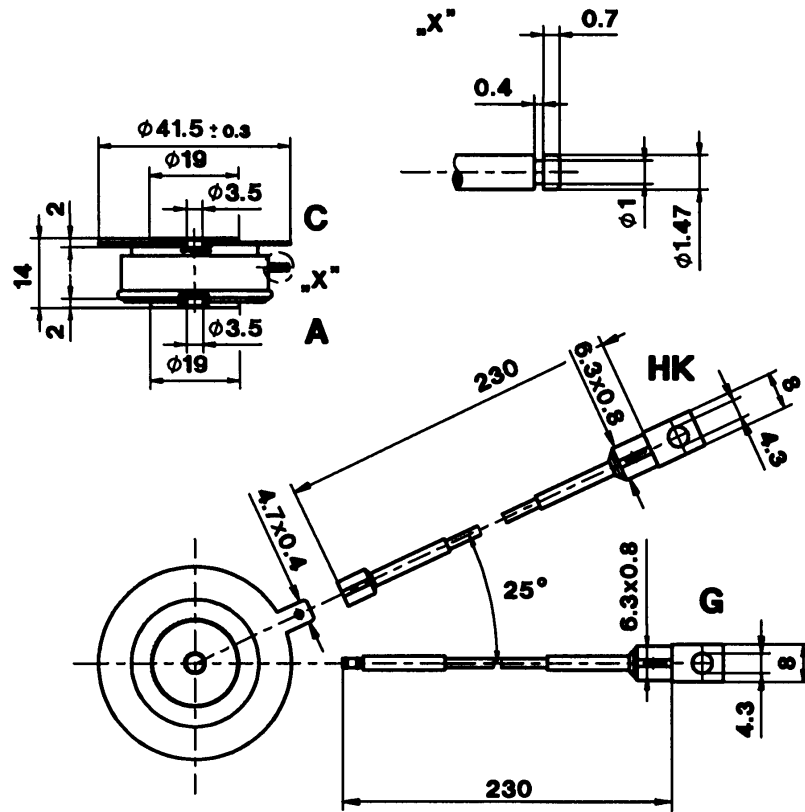

Fig. 9 Gate trigger characteristics

SKT 240
SKT 340

Case B 8

DIN 41814: 151 A 4
JEDEC: TO-200 AB



SKT 491
SKT 551

Case B 11

DIN 41814: 152 A 4
JEDEC: TO-200 AB

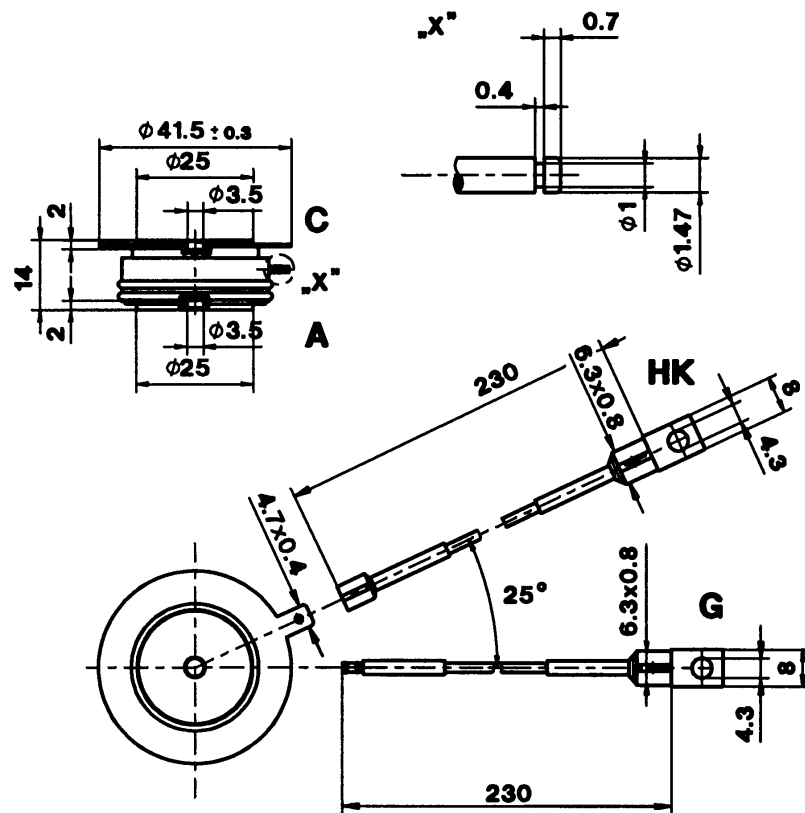

- C: Cathode terminal (red sleeve)
- A: Anode terminal
- G: Gate terminal (yellow sleeve)
- HK: Auxiliary cathode terminal (red sleeve)

Dimensions in mm