

V _{RSM}	V _{RRM} V _{DRM}	(dv/dt) _{cr}	I _{TRMS} (maximum values for continuous operation)	
			1400 A	1600 A
V	V	V/μs	I _{TAV} (sin. 180; T _{case} = . . . ; DSC)	
			890 A (57 °C)	1020 A (56 °C)
500	400	500	SKT 600/04 D	SKT 760/04 D
900	800	500	SKT 600/08 D	SKT 760/08 D
1300	1200	1000	SKT 600/12 E	SKT 760/12 E
1500	1400	1000	SKT 600/14 E	SKT 760/14 E
1700	1600	1000	SKT 600/16 E	SKT 760/16 E
1900	1800	1000	SKT 600/18 E	SKT 760/18 E

Thyristors

SKT 600 SKT 760



Features

- Hermetic metal cases with ceramic insulators
- Capsule packages for double sided cooling
- Shallow design with single sided cooling
- International standard cases
- Off-state and reverse voltages up to 1800 V
- Amplifying gate

Typical Applications

- DC motor control (e. g. for machine tools)
- Controlled rectifiers (e. g. for battery charging)
- AC controllers (e. g. for temperature control)

Symbol	Conditions	SKT 600	SKT 760	Units
I _{TAV}	sin. 180; (T _{case} = . . .); DSC	600 (85)	760 (80)	A °C
I _{TSM}	T _{vj} = 25 °C; 10 ms	11 500	15 000	A
	T _{vj} = 125 °C; 10 ms	10 000	13 000	A
i ² t	T _{vj} = 25 °C; 8,3 ... 10 ms	660	1 125	kA ² s
	T _{vj} = 125 °C; 8,3 ... 10 ms	500	845	kA ² s
t _{gd}	T _{vj} = 25 °C I _G = 1 A di _G /dt = 1 A/μs	typ. 1		μs
t _{gr}	V _D = 0,67 · V _{DRM}	typ. 2		μs
(di/dt) _{cr}	f = 50 ... 60 Hz	125		A/μs
I _H	T _{vj} = 25 °C; typ./max.	150 / 500		mA
I _L	T _{vj} = 25 °C; typ./max.	0,5 / 2		A
t _q	T _{vj} = 125 °C; typ.	100 ... 200		μs
V _T	T _{vj} = 25 °C; I _T = 2400 A; max.	2,0	1,65	V
V _{T(TO)}	T _{vj} = 125 °C	1,0	0,92	V
r _T	T _{vj} = 125 °C	0,4	0,3	mΩ
I _{DD} ; I _{RD}	T _{vj} = 125 °C; V _{RD} = V _{RRM} V _{DD} = V _{DRM}	80		mA
V _{GT}	T _{vj} = 25 °C	3		V
I _{GT}	T _{vj} = 25 °C	200		mA
V _{GD}	T _{vj} = 125 °C	0,25		V
I _{GD}	T _{vj} = 125 °C	10		mA
R _{thjc}	cont. DSC	0,038		°C/W
	sin. 180; DSC/SSC	0,040 / 0,082		°C/W
	rec. 120; DSC/SSC	0,045 / 0,093		°C/W
R _{thch}	DSC/SSC	0,007 / 0,014		°C/W
T _{vj}		- 40 ... + 125		°C
T _{stg}		- 40 ... + 130		°C
F	SI units	10 ... 13		kN
	US units	2200 ... 2850		lbs.
w		240		g
Case		B 10		

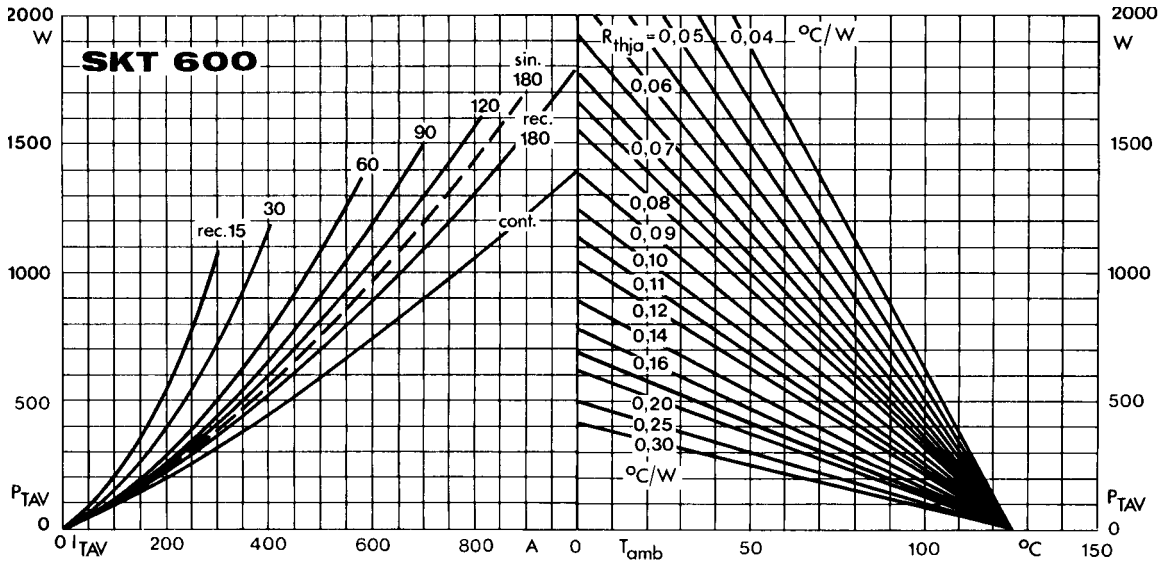

Fig. 1 a Power dissipation vs. on-state current and ambient temperature

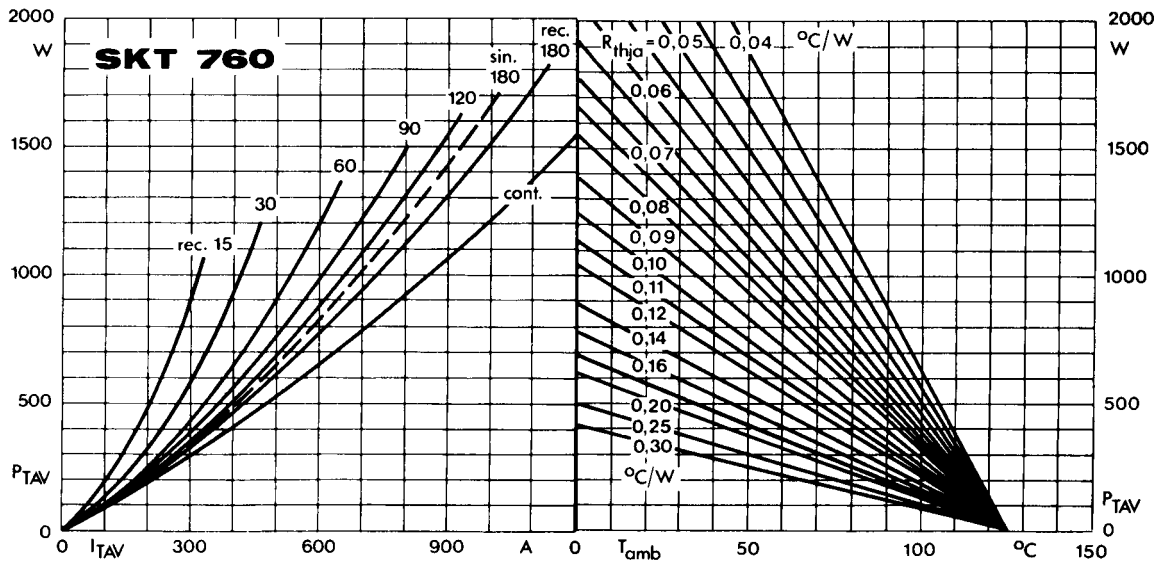

Fig. 1 b Power dissipation vs. on-state current and ambient temperature

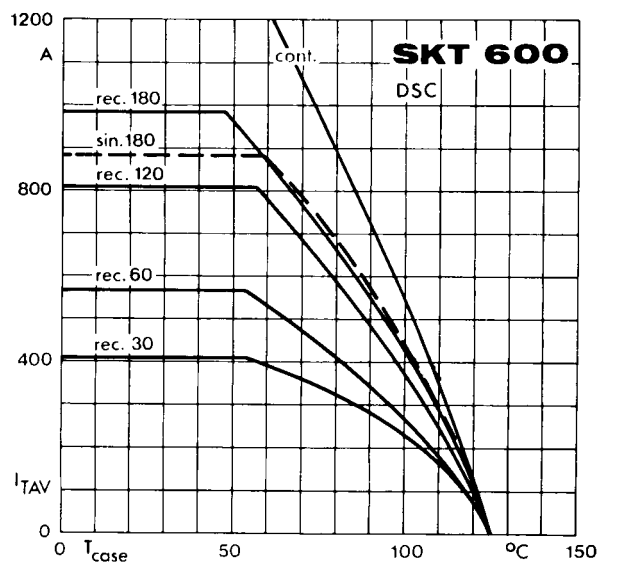

Fig. 2 a Rated on-state current vs. case temperature

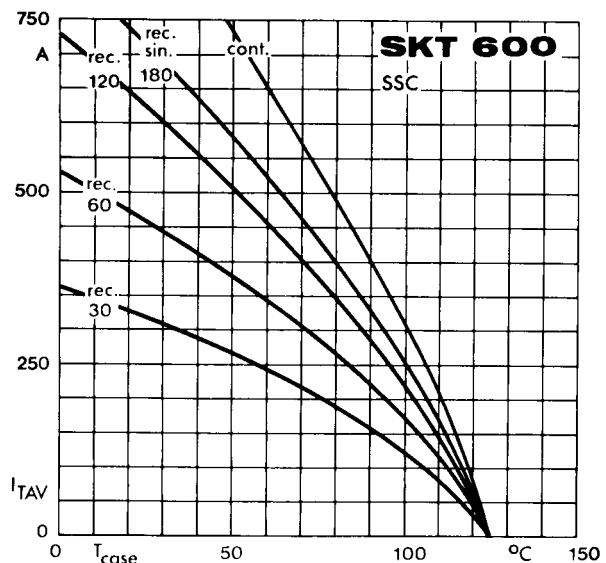

Fig. 2 b Rated on-state current vs. case temperature

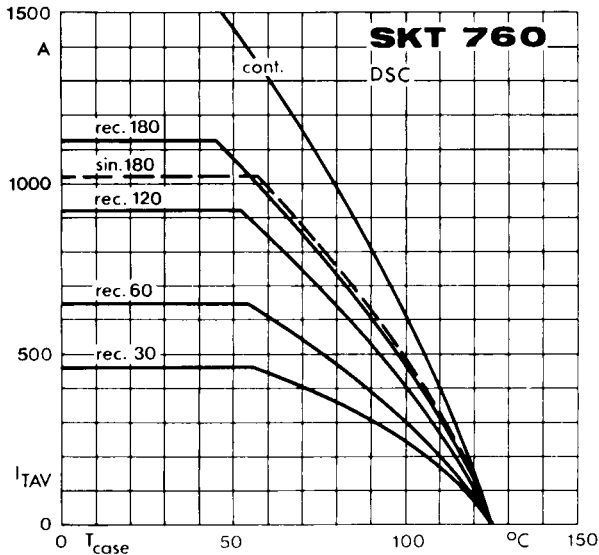

Fig. 2 c Rated on-state current vs. case temperature

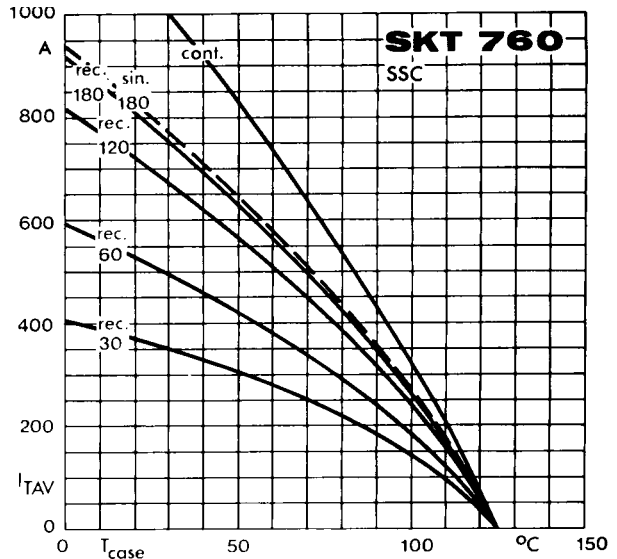

Fig. 2 d Rated on-state current vs. case temperature

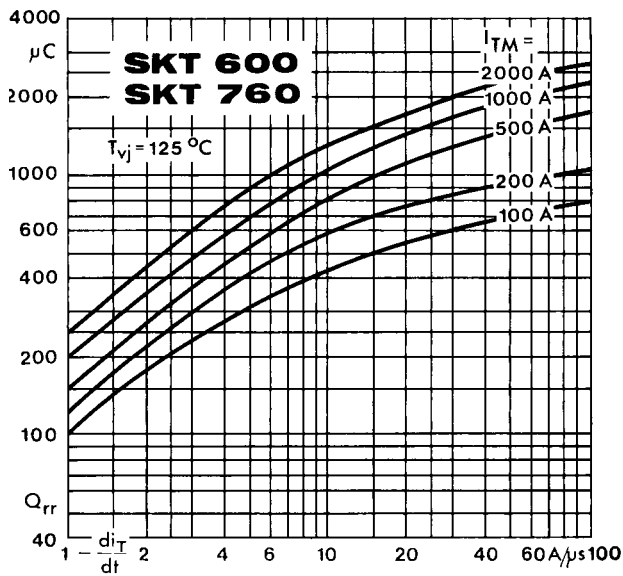

Fig. 3 Recovered charge vs. current decrease

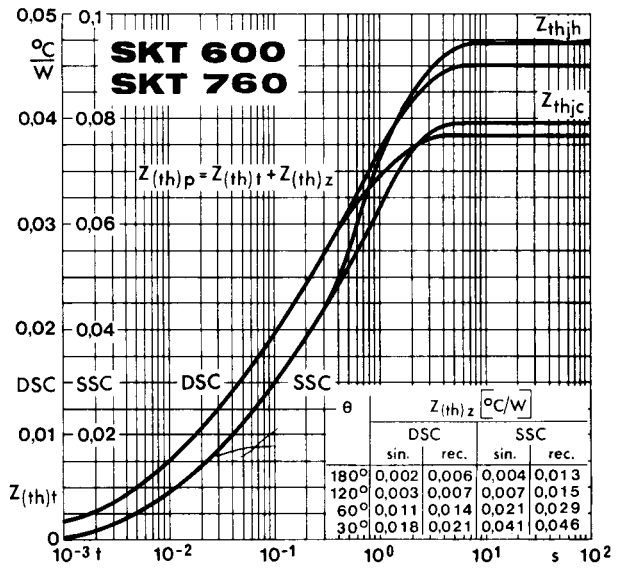

Fig. 4 Transient thermal impedance vs. time

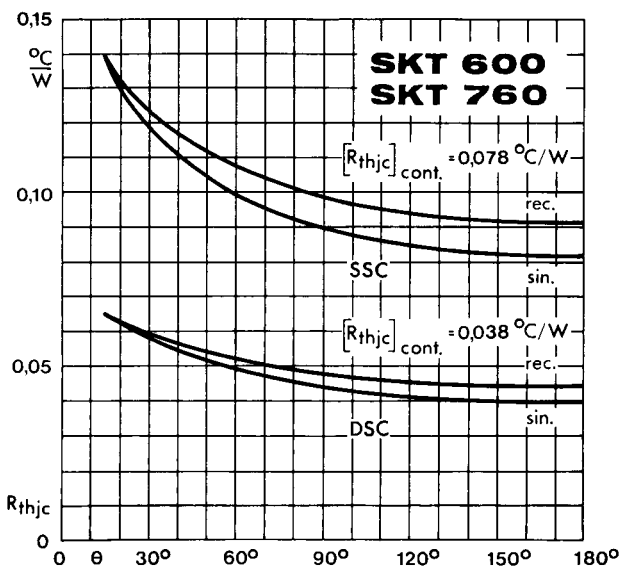

Fig. 5 Thermal resistance vs. conduction angle

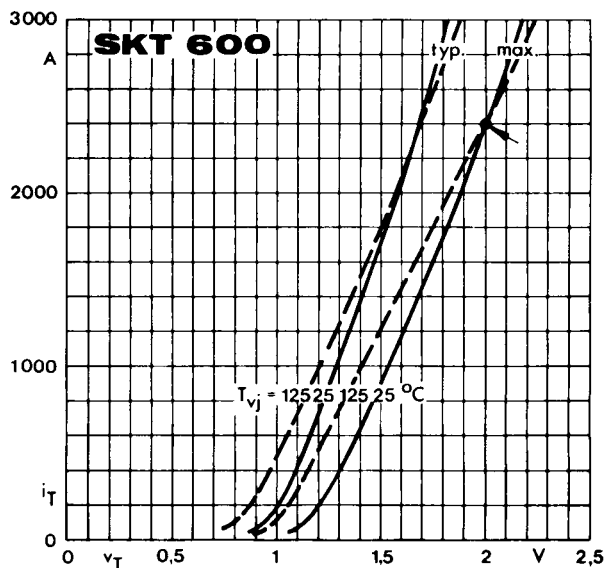

Fig. 6 a On-state characteristics

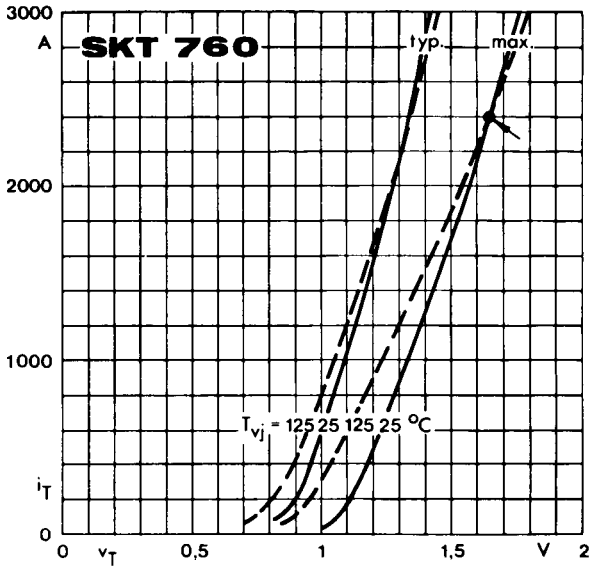

Fig. 6 b On-state characteristics

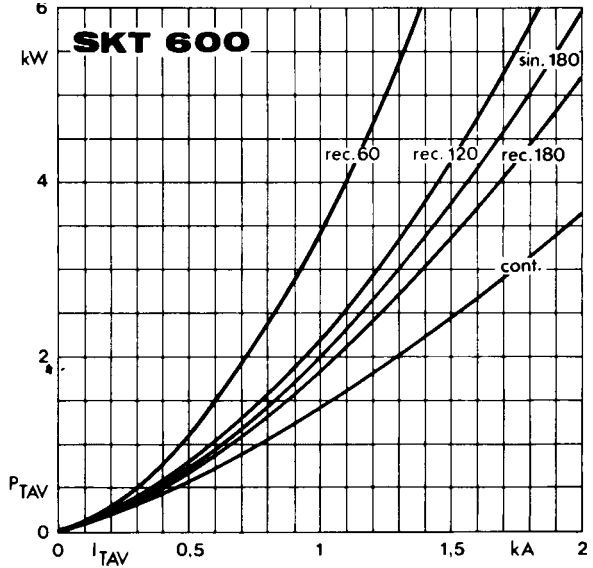

Fig. 7 a Power dissipation vs. on-state current

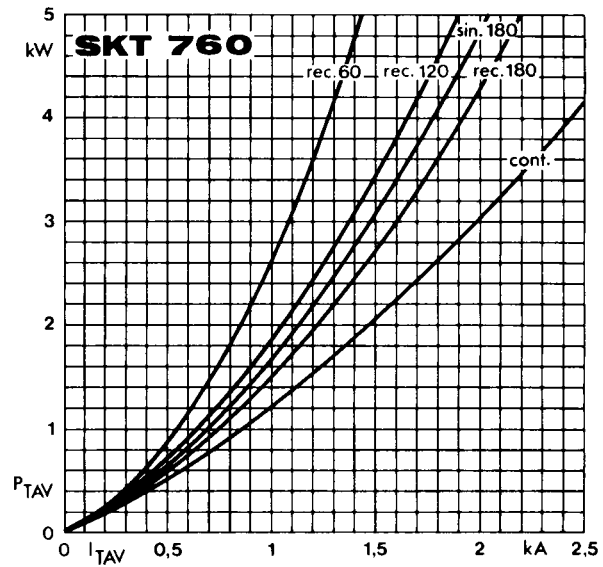

Fig. 7 b Power dissipation vs. on-state current

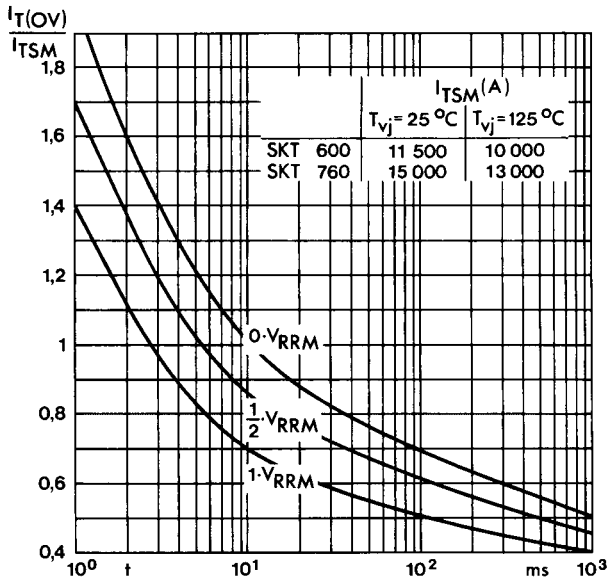

Fig. 8 Surge overload current vs. time

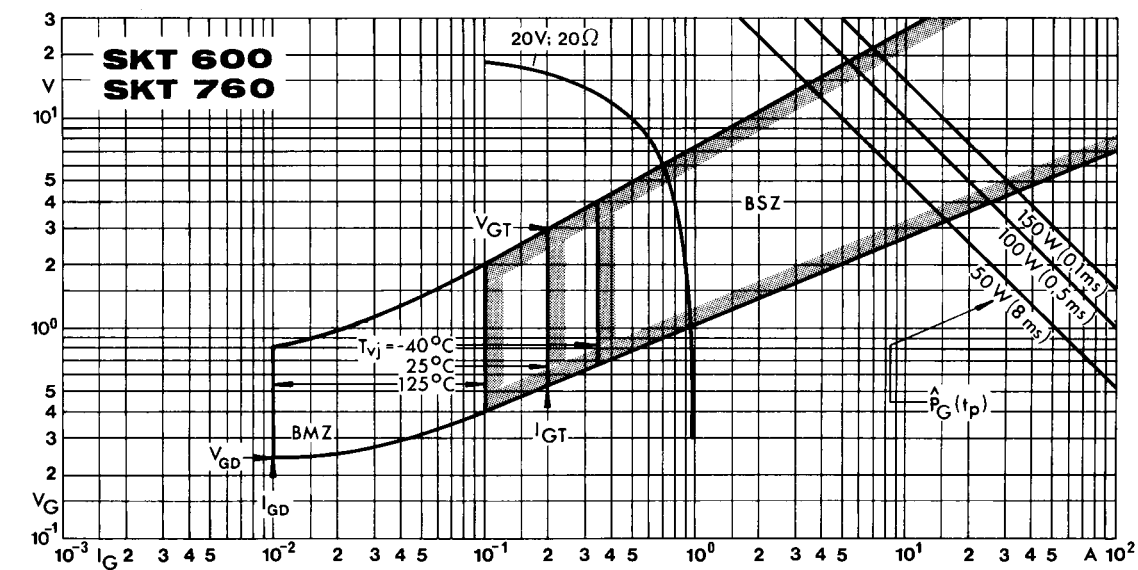

Fig. 9 Gate trigger characteristics

SKT 520
 SKT 600
 SKT 760

Case B 10

DIN 41814: 153 C 4

JEDEC: TO-200 AC

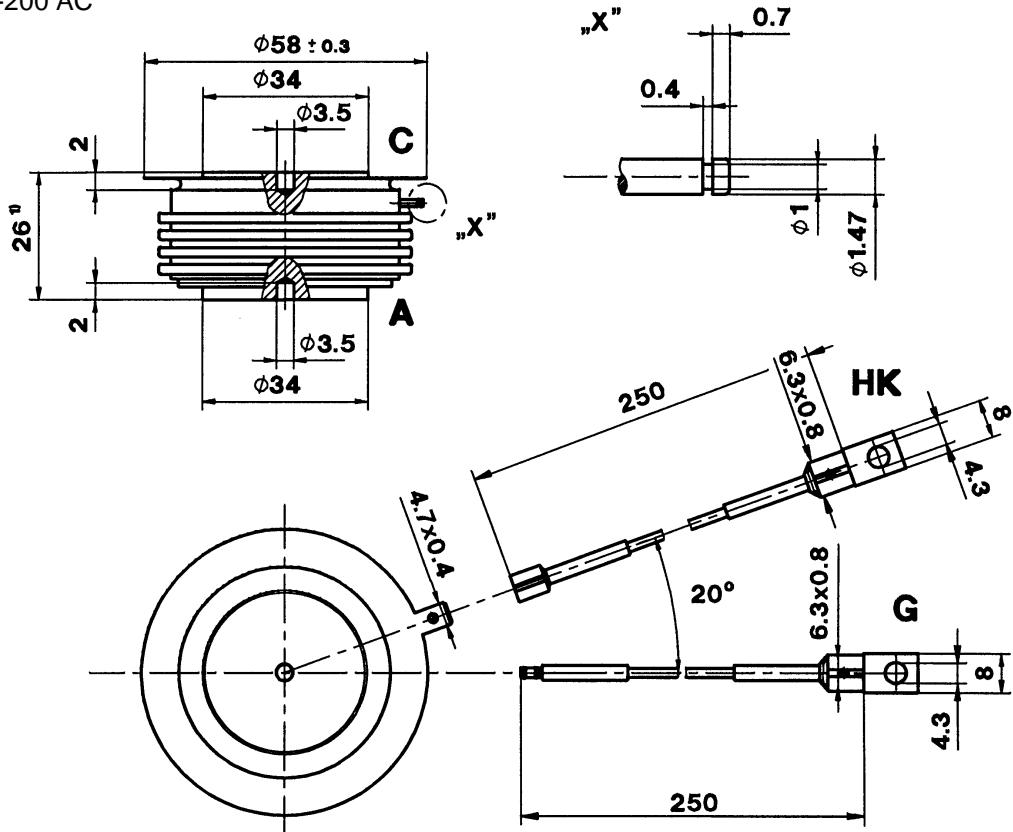

¹⁾ SKT 520/24 E } 27 mm
 SKT 520/28 E }

Dimensions in mm

- C: Cathode terminal
- A: Anode terminal
- G: Gate terminal (yellow sleeve)
- HK: Auxiliary cathode terminal (red sleeve)